

JAN-7201S/9201S

Simple ECDIS

Instruction Manual <Reference>

Overview	1
Name and Function of Each Unit	2
Common Basic Operations	3
Range and Bearing Measurement Methods	4
Target Tracking and AIS	5
Functions of the ECDIS	6
Route Planning	7
Route Monitoring	8
Monitoring a Dragging Anchor	9
Automatic Sailing (Unsupported)	10
Operating a Chart	11
Creating a User Map/ Updating a Chart Manually	12
Logbook	13
Setting Up Screen View	14
Setting Up Alerts	15
Setting Up the Operation Mode	16
Adjusting and Setting Up Equipment (for Services)	17
Playing Back Data Recorded During Navigation [Playback]	18
Maintenance & Inspection	19
Failures and After-Sale Services	20
About Disposal	21
Specifications	22
Alert List	APP A
Menu List and Materials	APP B

Contents

Reference

Section 17	Adjusting and Setting up Equipment (for Services).....	17-1
17.1	Service Menu	17-1
17.1.1	To display the Service menu:.....	17-1
17.2	Radar Adjustment.....	17-3
17.2.1	Displaying the [Adjustment] dialog box.....	17-3
17.2.2	Performing basic adjustments on the radar	17-4
17.2.2.1	Displaying the [Basic Adjustment] dialog.....	17-4
17.2.2.2	Adjusting the bearing.....	17-4
17.2.2.3	Adjusting a distance	17-5
17.2.3	Adjusting Antenna Height	17-5
17.2.4	Adjusting MBS	17-6
17.2.4.1	Displaying the [MBS] dialog.....	17-6
17.2.4.2	Performing MBS adjustment.....	17-7
17.2.4.3	Adjusting a MBS application range	17-7
17.3	Verifying Installation and Initial Setting	17-8
17.3.1	Displaying the [Installation] dialog box.....	17-8
17.3.2	Verifying/Setting CCRP (Consistent Common Reference Point).....	17-9
17.3.2.1	Displaying the [CCRP] dialog	17-9
17.3.2.2	Setting CCRP	17-10
17.3.3	Setting a Serial Port.....	17-11
17.3.3.1	Displaying the [Serial Port] dialog	17-12
17.3.3.2	[Selftest] lamp light colors.....	17-12
17.3.3.3	Setting a serial port.....	17-12
17.3.3.4	To change the communication settings of the Serial Port	17-15
17.3.4	Setting a System Function.....	17-18
17.3.4.1	Displaying a [System Function] dialog	17-18
17.3.4.2	Lamp light colors	17-18
17.3.4.3	Setting a system function	17-19
17.3.5	Setting Ship's Parameters	17-25
17.3.5.1	Displaying the [Ship's Parameters] dialog.....	17-25
17.3.5.2	Setting own ship's parameters	17-26
17.3.6	Setting the automatic sailing system	17-27
17.3.6.1	Displaying the [Autosail] dialog	17-27
17.3.6.2	Setting the automatic sailing system	17-27
17.3.7	Setting the AIS password.....	17-28
17.3.7.1	Displaying the [AIS] dialog.....	17-28
17.3.7.2	Setting the AIS password	17-28

17.3.8	Setting Sensor	17-29
17.3.8.1	Displaying the [Sensor] dialog	17-29
17.3.8.2	Displaying an alert set point	17-29
17.3.8.3	Setting the GPS switching linkage function.....	17-30
17.3.9	Setting Route Sharing.....	17-31
17.3.9.1	Displaying the [Route Sharing] dialog	17-31
17.3.9.2	Selecting a route sharing method.....	17-31
17.3.10	Setting the GPS Shared Route.....	17-32
17.3.10.1	Displaying the [GPS Shared Route] dialog.....	17-32
17.3.10.2	Setting the GPS Shared Route.....	17-32
17.3.11	Setting the Route Plan Exchange.....	17-34
17.3.11.1	Displaying the [Route Plan Exchange] dialog	17-34
17.3.11.2	Setting the Route Plan Exchange.....	17-34
17.4	Maintenance.....	17-35
17.4.1	Displaying the [Maintenance] dialog box	17-35
17.4.2	Managing storage	17-36
Section 18	Playing Back Data Recorded During Navigation	18-1
18.1	Playback Controller	18-3
18.2	Selecting Playback Data	18-6
18.2.1	Sorting the Playback List	18-6
18.3	Playing Back Logbook Data	18-7
18.3.1	Changing the playback speed	18-8
18.4	Exiting the Playback Mode.....	18-9
18.5	Outputting Navigation Record Data	18-10
18.6	Functional Restrictions When in the Playback Mode.....	18-12
Section 19	Maintenance & Inspection	19-1
19.1	Maintenance Functions Executed from Menu.....	19-1
19.1.1	Starting maintenance functions	19-1
19.1.2	Setting Date/Time/Time Zone	19-1
19.1.3	Confirming System Information	19-3
19.1.3.1	Confirming Software Information.....	19-4
19.1.3.2	Confirming H/W Key Information.....	19-5
19.1.3.3	Confirming the compliant standards for the equipment.....	19-7
19.1.4	Confirming Operating Time.....	19-8
19.1.5	Displaying and Resetting the Current Voyage Distance.....	19-9
19.1.6	Setting and confirming the Sensor Source	19-11
19.1.7	Checking the Route Plan Exchange Log	19-13
19.2	General Maintenance.....	19-14
19.3	Maintenance on Unit	19-15
19.3.1	Display unit	19-15
19.3.1.1	The Screen	19-15

19.3.1.2	The Trackball	19-16
19.4	Performance Check	19-17
19.4.1	Starting Selftest functions	19-17
19.4.2	Confirming the screen status [Monitor Test]	19-18
19.4.3	Confirming the operation of the operation unit [Key Test].....	19-22
19.4.4	Confirming the alert sound [Sound Test].....	19-23
19.4.5	Testing the brightness of LED [Light Test]	19-24
19.4.6	Checking the memory [Memory Check].....	19-25
19.4.7	Cleaning the lens of the DVD drive.....	19-26
19.5	Replacement of Major Parts.....	19-28
19.5.1	Parts expected for periodic replacement	19-28
19.6	Software Update	19-29
19.7	Firmware Update.....	19-32
19.8	Updating Help Data.....	19-35
19.9	Confirming Maintenance INFO	19-38
19.9.1	Screen items/fields and their function.....	19-38
19.9.2	Switching to the standard window or the expanded window	19-41
19.9.3	Exporting maintenance information	19-43
19.10	Data Backup/Restore	19-44
19.10.1	Backing up data	19-44
19.10.2	Restoring backed up data	19-46
19.11	Recovery of the Images in the C Drive	19-48
19.11.1	Starting the equipment with the OS in the D drive.....	19-49
19.11.2	Executing the SSD recovery tool	19-49
19.11.3	Starting the equipment with the OS in the C drive (Software automatic recovery) ..	19-50
19.11.4	Re-setting C-MAP	19-51
Section 20	Failures and After-Sale Services.....	20-1
20.1	Failure Detection	20-1
20.1.1	About alerts.....	20-1
20.1.2	Alert description	20-1
20.1.3	S-57/63 chart related error message list.....	20-1
20.1.4	ARCS chart related error message list	20-1
20.1.5	Fuse inspection.....	20-2
20.2	Countermeasures for Failures	20-3
20.2.1	Repair circuit block.....	20-3
20.3	Troubleshooting.....	20-5
20.4	After-Sale Services	20-15
20.4.1	About the retaining period of service parts	20-15
20.4.2	When requesting a repair	20-15
20.4.3	Recommendation of inspection and maintenance.....	20-15
20.4.4	Extending the functions	20-17

20.4.4.1 Importing the license information	20-17
Section 21 About Disposal.....	21-1
21.1 About Disposal of This Equipment.....	21-1
21.2 Chinese Version RoHS	21-2
Section 22 Specifications.....	22-1
22.1 JAN-9201S.....	22-1
22.2 JAN-7201S.....	22-2
22.3 Display Unit.....	22-3
22.4 Central Control Unit.....	22-6
22.5 Power Supply Unit.....	22-7
22.6 Trackball Operation Unit	22-8
22.7 19inch Display (NWZ-207)	22-9
22.8 19inch Display (NWZ-214)	22-10
22.9 26inch Display.....	22-11
22.10 Keyboard OPU.....	22-12
22.11 26inch Display Unit Mount Kit.....	22-13
22.12 19inch Display Unit Mount Kit.....	22-13
22.13 Sensor LAN switch unit.....	22-14
22.14 Junction Box.....	22-16
Appendix A Alert, Maintenance INFO and Permanent information	A-1
A.1 Alert	A-1
A.1.1 Priority: Alarms.....	A-2
A.1.2 Priority: Warnings.....	A-3
A.1.3 Priority: Cautions.....	A-9
A.1.4 List of Alert escalation	A-15
A.1.5 List of Alerts with responsibility-transferred state	A-16
A.1.6 List of Aggregated Alerts	A-17
A.1.7 List of Alert Icons.....	A-20
A.2 Maintenance INFO	A-21
A.3 Permanent Information.....	A-41
Appendix B Menu List and Materials.....	B-1
B.1 Menu List.....	B-1
B.1.1 Route Planning	B-1
B.1.2 Route Monitoring	B-3
B.1.3 Anchor Watch	B-4
B.1.4 Autosail *	B-5
B.1.5 Chart	B-6
B.1.6 User Chart	B-8
B.1.7 Logbook	B-9

B.1.8	TT/AIS	B-10
B.1.9	Tools	B-13
B.1.10	View	B-16
B.1.11	Alert	B-21
B.1.12	Settings	B-22
B.1.13	Chart Maintenance	B-27
B.1.14	Maintenance	B-29
B.1.15	Help	B-31
B.1.16	Code Input	B-32
B.1.17	Service	B-33
B.2	Context Menu List	B-40
B.2.1	No object	B-40
B.2.1.1	ECDIS (S57/C-MAP) screen	B-40
B.2.1.2	ECDIS(ARCS) screen	B-41
B.2.2	AIS	B-42
B.2.2.1	Sleeping AIS target	B-42
B.2.2.2	Activated AIS target	B-43
B.2.2.3	Numeric displayed AIS target	B-44
B.2.3	TT	B-45
B.2.3.1	Internal TT	B-45
B.2.3.2	External TT	B-45
B.2.3.3	TT detail information display (internal TT)	B-45
B.2.3.4	TT detail information display (external TT)	B-45
B.2.4	NAVTEX	B-46
B.2.4.1	NAVTEX	B-46
B.2.5	Mariner's Mark/Line	B-47
B.2.5.1	Event mark	B-47
B.2.5.2	Information mark	B-47
B.2.5.3	Current mark	B-47
B.2.5.4	Clearing line	B-47
B.2.5.5	Highlighted display	B-48
B.2.6	User map	B-49
B.2.6.1	Symbol	B-49
B.2.6.2	Simple line	B-49
B.2.6.3	Line - Circle	B-49
B.2.6.4	Line - Ellipse	B-49
B.2.6.5	Arc	B-50
B.2.6.6	Polygon	B-50
B.2.6.7	Area - Circle	B-50
B.2.6.8	Area - Ellipse	B-50
B.2.6.9	Fan	B-51
B.2.6.10	Text	B-51
B.2.6.11	Arrow	B-51



B.2.7	Manual Update (S-57)	B-52
B.2.7.1	Symbol	B-52
B.2.7.2	Simple line	B-52
B.2.7.3	Line - Circle	B-52
B.2.7.4	Line - Ellipse	B-52
B.2.7.5	Arc	B-53
B.2.7.6	Polygon	B-53
B.2.7.7	Area - Circle	B-53
B.2.7.8	Area - Ellipse	B-53
B.2.7.9	Fan	B-54
B.2.7.10	Text	B-54
B.2.7.11	Arrow	B-54
B.2.8	Manual Update (ARCS, C-MAP)	B-54
B.2.8.1	Objects that have not been saved	B-54
B.2.8.2	Saved objects (hidden)	B-54
B.2.9	Monitored route	B-55
B.2.9.1	Monitored route	B-55
B.2.10	Planned track	B-56
B.2.10.1	Planned track	B-56
B.2.11	Monitoring dragging anchor	B-57
B.2.11.1	Dragging anchor monitoring circle	B-57
B.2.11.2	Dragging anchor monitoring polygon	B-57
B.3	Abbreviations of Geodetic Data	B-58
B.4	Lists of Terminologies, Units, and Abbreviations	B-60
B.5	Icon Button List for User Map	B-69
B.6	Icon Button List for Manual Update (S-57)	B-74
B.6.1	Symbol	B-75
B.6.2	Line	B-79
B.6.3	Area	B-85
B.6.4	Text	B-101
B.6.5	ENC object attributes	B-102
B.7	Icon Button List for Manual Update (ARCS and C-MAP)	B-115
B.7.1	Symbol	B-116
B.7.2	Line	B-134
B.7.3	Area	B-138
B.7.4	Text	B-139
B.8	List of Navigation-related Symbols	B-140
B.8.1	Related to own ship symbols	B-140
B.8.2	TT/AIS related	B-142
B.8.3	Navigation monitoring related	B-143
B.8.4	Tool related	B-144
B.9	List of Icons/Icon Buttons	B-146

B.10	Data Format of the File that can be Imported/Exported in the ECDIS.....	B-152
B.10.1	File Types.....	B-152
B.10.2	File Name.....	B-152
B.10.3	CSV File Data Structure	B-152
B.10.4	Route File.....	B-153
B.10.5	User Map File.....	B-155
B.10.6	Log Book File	B-173



Section 17 Adjusting and Setting up Equipment (for Services)

This section describes the methods for radar adjustment, installation verification, and maintenance that are conducted by the service staff by using the Service menu at installation construction of this equipment.

 CAUTION	
	Any adjustments must be made by specialized service personnel. Incorrect settings may result in unstable operation, and this may lead to accidents or equipment failure.
	Do not make any adjustments during navigation. Failure may result in adverse effects on the radar function which may lead to accidents or equipment failure.

17.1 Service Menu

The Service menu consists of three submenus of Adjustment, Installation and Maintenance. To display the Service menu, a password is required.

17.1.1 To display the Service menu:

- 1** Click on the [MENU] button on the left toolbar.
The menu is displayed.

- 2 Change over to the second page using the page switching button, and click the [Code Input] button.

The password input dialog is displayed.

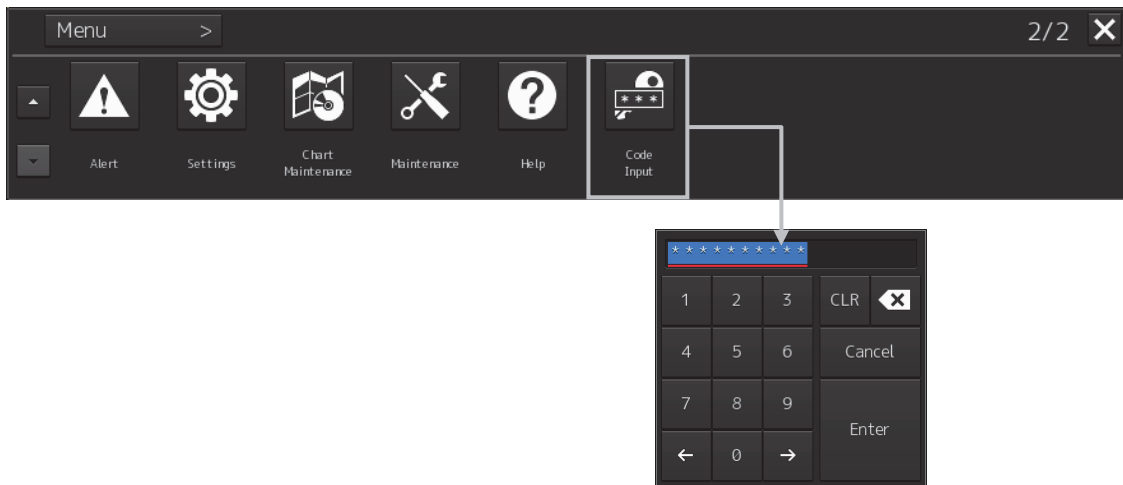

- 3 Enter 0 in Password.
- 4 Click on the [MENU] button on the left toolbar.
The menu is displayed.
- 5 Change to the 2nd page by using the page change button.
The [Service] button is added.

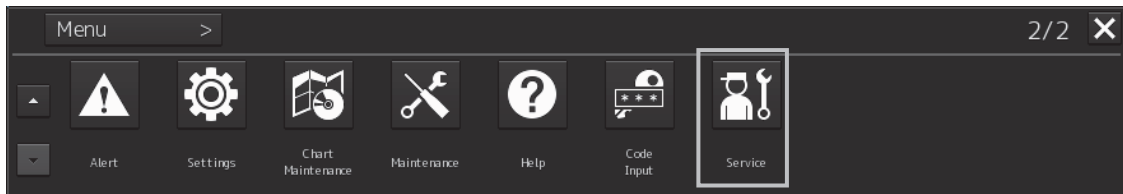

- 6 Click on the [Service] button.
The submenu is displayed.

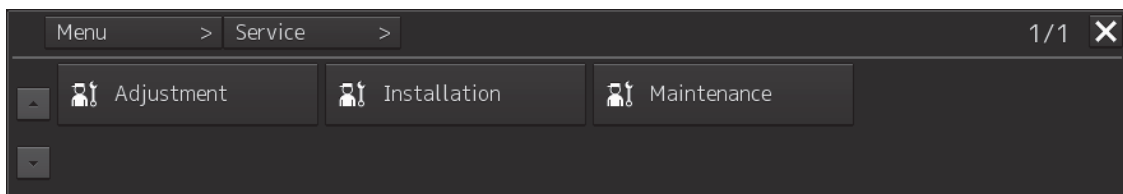

- 7 Display a submenu dialog box by clicking on one of the [Adjustment], [Installation], and [Maintenance] buttons.

17.2 Radar Adjustment

Note

In case of JAN-7201S/9201S, overlay function is not available by function restriction.
Therefore the setup is not available.

Use the [Adjustment] dialog box to adjust the radar of this equipment.

17.2.1 Displaying the [Adjustment] dialog box

Clicking the [Adjustment] button in the submenu displays the [Adjustment] dialog box.

The [Adjustment] dialog box consists of the classification pane and the edit pane.

By clicking the Disclosure button (>>), you can hide the edit pane. To show the edit pane again, click the Disclosure button (<<).

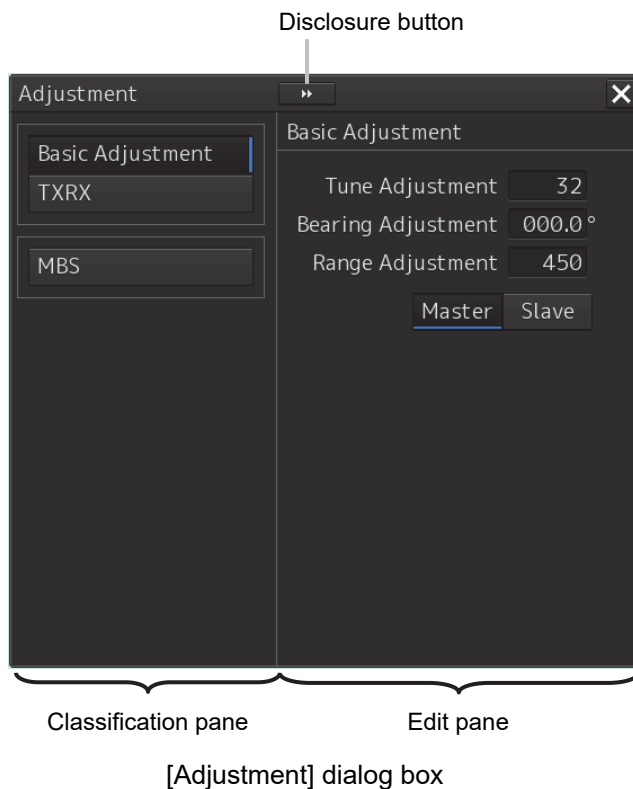

- 1 Click the item you want to set up in the classification pane.**
The setup dialog of the item you selected appears in the edit pane.
- 2 Set up in the edit pane.**

17.2.2 Performing basic adjustments on the radar

Perform basic adjustments on the radar by using the [Basic Adjustment] dialog.

17.2.2.1 Displaying the [Basic Adjustment] dialog

When you select [Basic Adjustment] in the classification pane, the [Basic Adjustment] dialog is displayed in the edit pane.



17.2.2.2 Adjusting the bearing

Adjust the bearing so that the bearing of the target measured by the compass on the ship and the bearing of the image that is displayed on the radar match.

Note

This function is disabled when the radar interswitch is set to the Slave mode.

- 1 Set the bearing mode to [H UP] and set the image processing mode to [Process Off].**
For the bearing mode setting method, refer to "6.6.2 Setting Bearing mode (S-57/C-MAP only)".
- 2 Measure a bearing in the ship's heading direction of a suitable target (for instance, halted ship, breakwater, and buoy) by using the compass on the ship.**
- 3 Click on the [Bearing Adjustment] input box.**
A numeric value input keyboard is displayed.

-
-
- 4 Input an adjustment value in the input box so that the bearing of the target that was measured in Step 2 indicates a correct bearing. (0 to 359.9°)**

For the method of using the numeric input keyboard, refer to "3.16.2 Name and function of each section of the keyboard".

17.2.2.3 Adjusting a distance

Adjust the distance of the target on the screen so that the correct distance is displayed.

- 1 On the screen, specify a target whose distance is available in advance.**
- 2 Click on the [Range Adjustment] input box.**
A numeric value input keyboard is displayed.
- 3 Enter an adjustment value in the input box so that the distance of the target specified in Step 1 indicates the correct distance. (128 to 1024)**

For the method of using the numeric input keyboard, refer to "3.16.2 Name and function of each section of the keyboard".

17.2.3 Adjusting Antenna Height

Adjust the antenna by using the [TXRX] dialog.

When you select [TXRX] in the classification pane, the [TXRX] dialog is displayed in the edit pane.

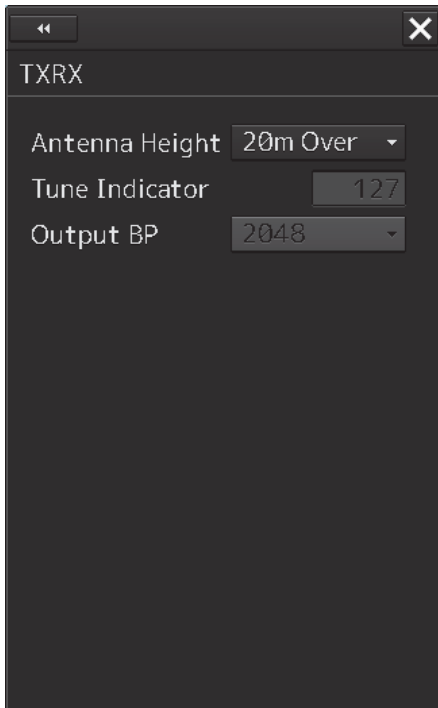



- 1 Measure the height from the sea surface to the radar antenna.
- 2 In the [Antenna height] combo box, select the setting value corresponding to the height of the antenna that was measured in step 1.
 - Under 5 m
 - 5-10 m
 - 10-20 m
 - 20 m Over

17.2.4 Adjusting MBS

MBS (Main Bang Suppression) adjustment is to adjust a display unit processing circuit in order to suppress main bang, which is the reflection signal from a microwave transmission circuit of a waveguide that normally appears as an image of a circle at the center of the radar screen.

Perform MBS adjustment by using the [MBS] dialog.

**WARNING**



Do not change Initial Level/Area Offset unless absolutely necessary. Incorrect adjustment will result in deletion of nearby target images and thus collisions may occur resulting in death or serious injuries.

17.2.4.1 Displaying the [MBS] dialog

When you select [MBS] in the classification pane, the [MBS] dialog is displayed in the edit pane.

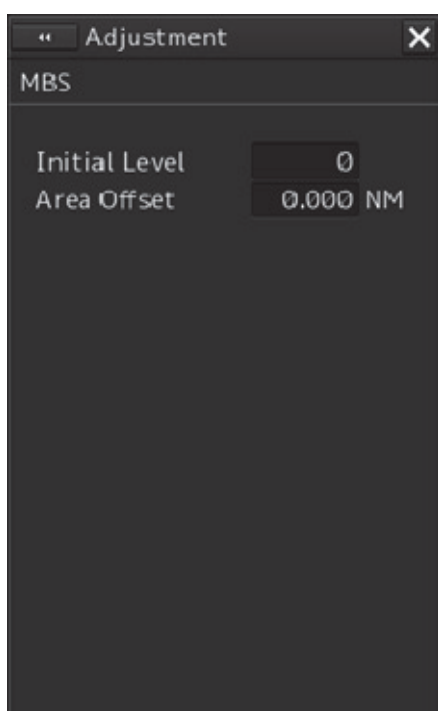

17.2.4.2 Performing MBS adjustment

1 Click on the [Initial Level] (MBS initial level) input box.

A numeric value input keyboard is displayed.

2 Enter an initial level of MBS so that the image of main bang becomes optimum (faint image remains on the screen. (0 to 1023)

For the method of using the numeric input keyboard, refer to "3.16.2 Names and functions of the sections of the keyboard".

17.2.4.3 Adjusting a MBS application range

1 Expand the display range up to the range where a main bang can be identified.

2 Click the [Area Offset] (MBS application) input box.

A numerical value input keyboard is displayed.

3 Adjust the application range so that the main bang adjustment range becomes the optimum (distance where only the main bang section becomes the MBS adjustment range) (-0.200NM ~ 0.200NM).

Adjust the range together with the MBS adjustment to the degree where the nearest target will not be lost.

For the method of using the numerical value input keyboard, refer to "3.16.2 Name and Function of Each Section of the Keyboard".

17.3 Verifying Installation and Initial Setting

Use the [Installation] dialog box to verify the installation of this equipment and perform initial setting.

17.3.1 Displaying the [Installation] dialog box

Clicking on the [Installation] in the submenu, the [Installation] dialog box appears.

The [Installation] dialog box consists of the classification pane and the edit/result pane. The classification pane consists of two-level layers of the first classification pane and the second classification pane.

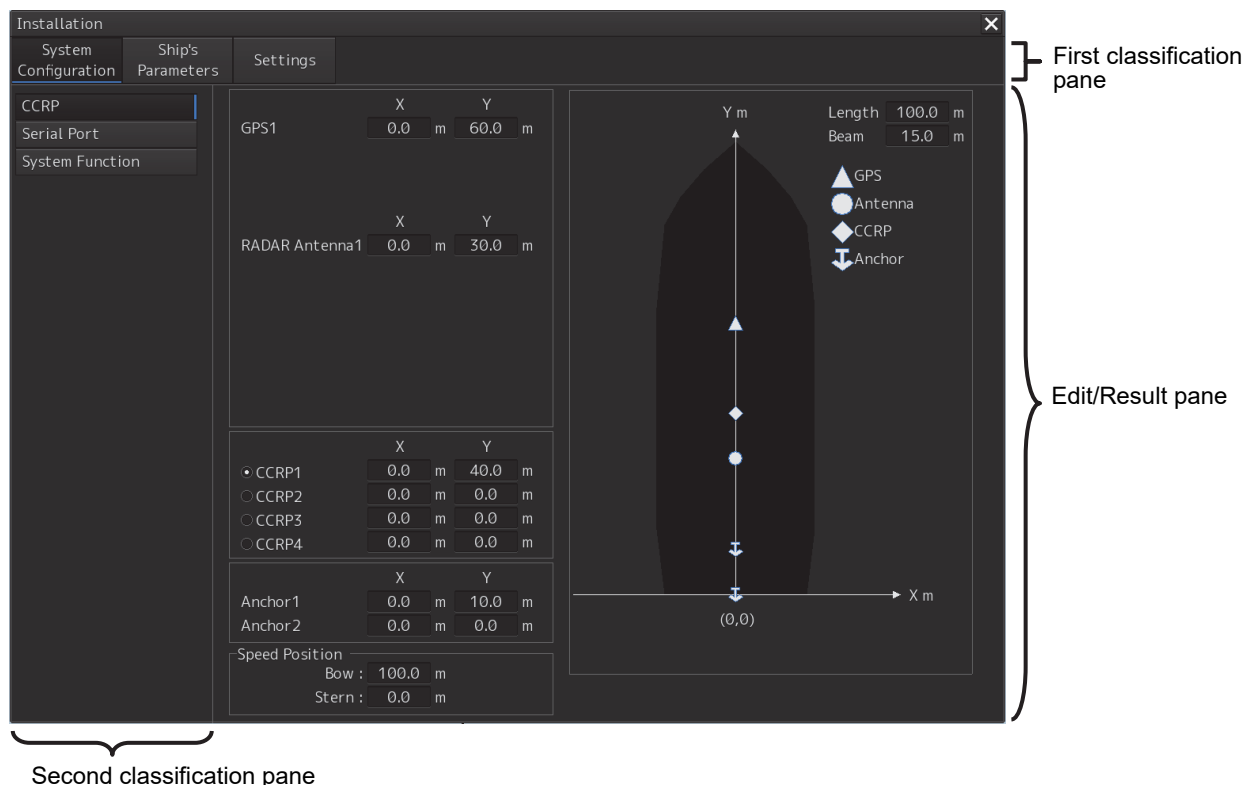

1 Click the item you want to set up in the classification pane.

The setup dialog of the item you selected is displayed in the edit/result pane.

2 Set up in the edit/result pane or check the setup result.

17.3.2 Verifying/Setting CCRP (Consistent Common Reference Point)

Set a measurement reference position (CCRP) on own ship by using the [CCRP] dialog.

17.3.2.1 Displaying the [CCRP] dialog

When you select [System Configuration] in the first classification pane and [CCRP] in the second classification pane, the [CCRP] dialog is displayed in the edit/result pane.

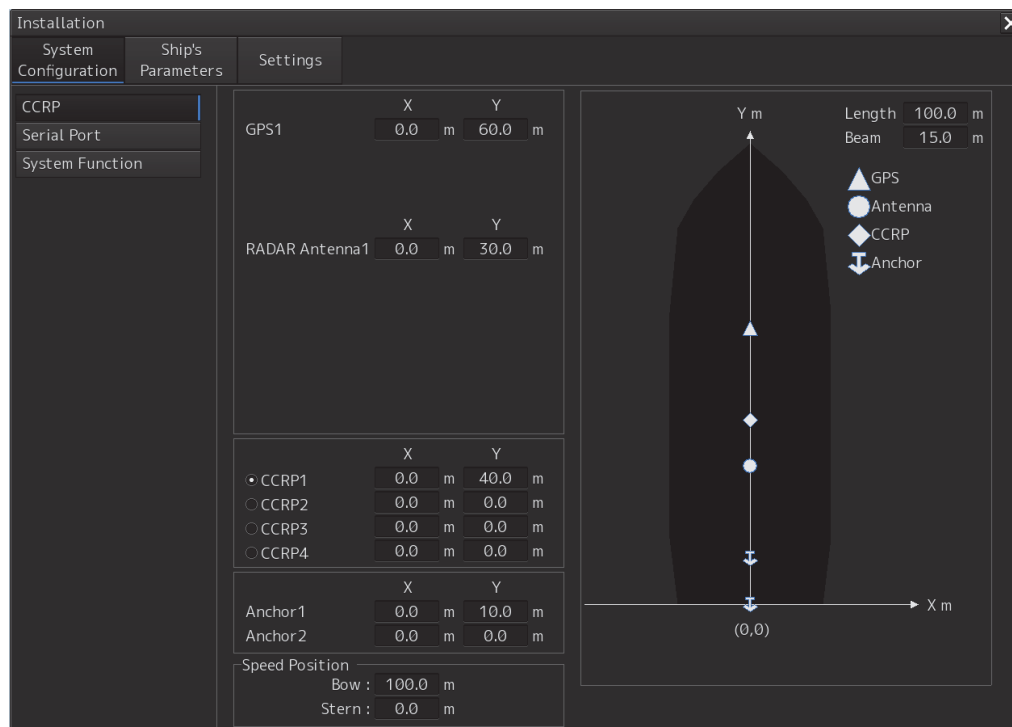

Note

Set up the GPS radar antenna correctly. The latitude and longitude data received from the GPS is compensated and then displayed as own ship's latitude and longitude. If the GPS radar antenna is not set up correctly, an AIS symbol and a radar echo may deviate when displayed.

17.3.2.2 Setting CCRP

Set the following items in the [CCRP] dialog.

Setting Item	Description of Setting	Setting Value
Length (of ship)	Enter the ship's length in the box.	1.0 to 1022.0m
Beam (ship's width)	Enter the ship's width in the box.	1.0 to 126.0m
GPSx (When two or more GPS units are present, "x" indicates the unit number.)	<p>Enter the equipment positions of GPSx in the boxes.</p> <p>X: Horizontal axis position on the ship of the applicable GPS (Center: 0)</p> <p>Y: Front-back axis position on the ship of the applicable GPS (Stern: 0)</p> <p>Note</p> <ul style="list-style-type: none"> This item may not be displayed depending on the equipment setting. When the input range is changed by modifying [Length] and [Beam], if a value exceeding the input range after modifying has already been entered, the value will be corrected to the maximum or minimum value. 	<p>Changes depending on the value of [Length] and [Beam].</p> <p>If Length=a and Beam=b:</p> <p>X -b/2 to b/2</p> <p>Y 0.0 to a</p> <p>For example,</p> <ul style="list-style-type: none"> if Length=1.0 and Beam=1.0: X -0.5 to 0.5 Y 0.0 to 1.0 if Length=700.0 and Beam=70.0: X -35.0 to 35.0 Y 0.0 to 700.0
Radar Antennas1 to 8 (equipment positions of radar antennas1 to 8)	<p>Enter the equipment positions of Radar Antennas1 to 8 in the boxes.</p> <p>X: Horizontal axis position of radar antennas 1 to 8 on the ship (Center: 0)</p> <p>Y: Front-back axis position of radar antennas 1 to 8 on the ship (Stern: 0)</p> <p>Note</p> <ul style="list-style-type: none"> If "No Equipment" is specified in the [DipSW] settings of the interswitch unit, this is not displayed. When the input range is changed by modifying [Length] and [Beam], if a value exceeding the input range after modifying has already been entered, the value will be corrected to the maximum or minimum value. 	
CCRP1/2/3/4	<p>Enter the positions of CCRP1 to CCRP4 of the ship in the boxes.</p> <p>X: Horizontal axis position of CCRP1/2/3/4 on the ship (Center: 0)</p> <p>Y: Front-back axis position of CCRP1/2/3/4 on the ship (Stern: 0)</p> <p>Note</p> <p>When the input range is changed by modifying [Length] and [Beam], if a value exceeding the input range after modifying has already been entered, the value will be corrected to the maximum or minimum value.</p>	

Setting Item	Description of Setting	Setting Value
Radio button on the left side of each CCRP	Select the position to be used as the ship's CCRP by clicking the applicable button.	CCRP1 CCRP2 CCRP3 CCRP4
Anchor1	An anchor position can be set as an offset from the stern center. It can not be set outside the boat. X: The horizontal axis position on the shipboard of Anchor 1 (center is 0) Y: Front-rear axis position on the shipboard of Anchor 1 (stern is 0)	If Length=a and Beam=b: X -b/2 to b/2 Y 0.0 to a
Anchor2	An anchor position can be set as an offset from the stern center. It can not be set outside the boat. X: The horizontal axis position on the shipboard of Anchor 2(center is 0) Y: Front-rear axis position on the shipboard of Anchor 2 (stern is 0)	If Length=a and Beam=b: X -b/2 to b/2 Y 0.0 to a
Speed Position Bow	Enter the distance to the bow starboard/port speed display point.	0.0 to Ship's length m
Speed Position Stern	Enter the distance to the stern starboard/port speed display point.	0.0 to Ship's length m

Synchronizing setting

The [CCRP] dialog enables common setting items and individual setting items for RADAR, ECDIS, and Conning (called a task station individually). Once common items are set in any of the task stations, RADAR, ECDIS, and Conning, the settings are reflected (synchronized) in other task stations.

By setting common items in the state where all the task stations are active, the common setting items are synchronized in all the task stations.

17.3.3 Setting a Serial Port

Verify the setting of the serial port of this equipment and perform initial setting by using the [Serial Port] dialog.

Synchronizing setting

The [Serial Port] dialog enables common setting items and individual setting items for RADAR, ECDIS, and Conning (called a task station individually). Once common items are set in any of the task stations, RADAR, ECDIS, and Conning, the settings are reflected (synchronized) in other task stations.

By setting common items in the state where all the task stations are active, the common setting items are synchronized in all the task stations.

17.3.3.1 Displaying the [Serial Port] dialog

When you select [System Configuration] in the first classification pane and [Serial Port] in the second classification pane, the [Serial Port] dialog is displayed in the edit/result pane.

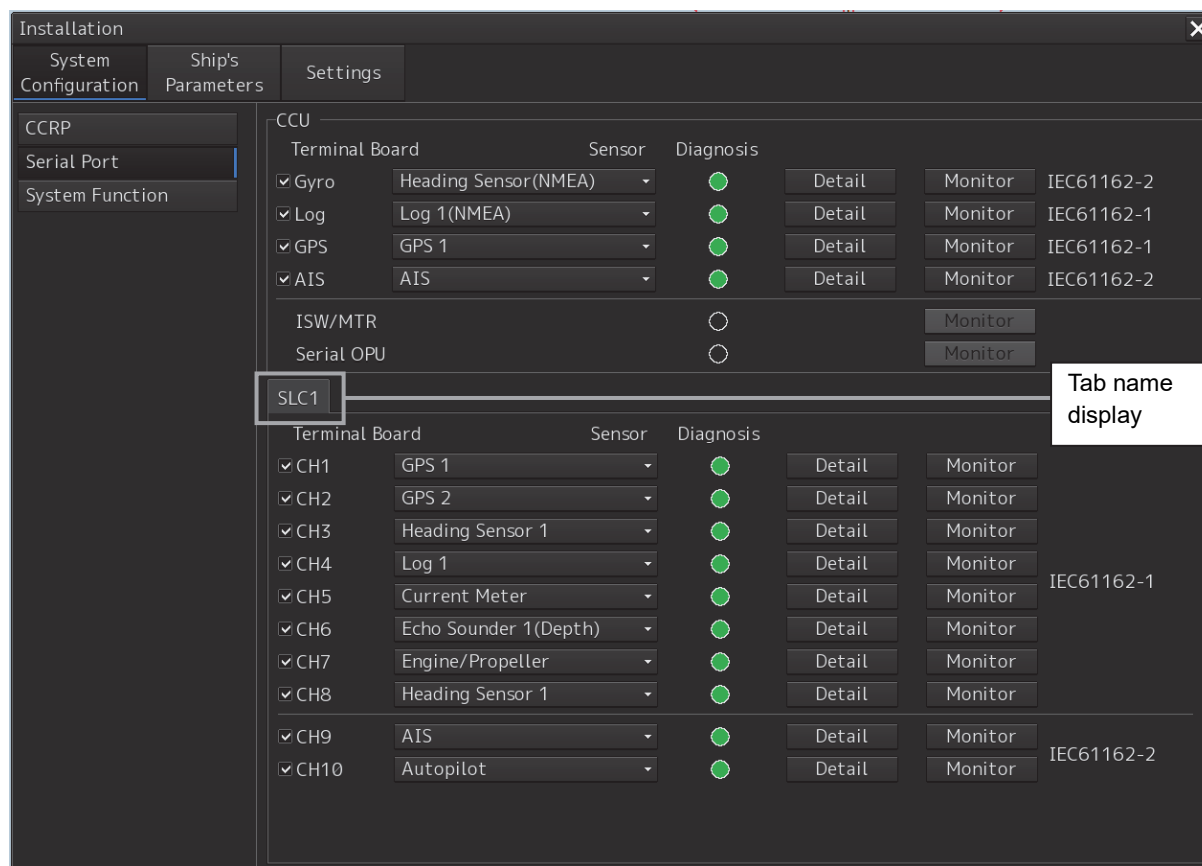

17.3.3.2 [Selftest] lamp light colors

The [Selftest] lamp indicates the Selftest result on whether or not the sentence of the sensor specified for each serial port has been received successfully and the status of ISW/MTR/Serial OPU.

- Lit in red:** Data not received.
- Lit in green:** Data is receiving.
- Lit in orange:** In Selftest(before decision).
- No color:** Serial port is disabled.

17.3.3.3 Setting a serial port

In the [Serial Port] dialog, allocate the sensors to be connected for the serial port on CCU (Central Control Unit) and the serial port on SLC/ALC.

Setting a serial port on the CCU

Set each item as follows.

"Table A: Sensors that can be selected by serial ports on CCU" shows selectable sensors.

However, the sensors that actually can be selected vary depending on the equipment setting.

For the sensor communication speed, refer to "Selectable baud rates".

Setting Item	Description of Setting	Setting Value
Gyro	<ol style="list-style-type: none"> 1. Select the check box and enable the serial port for the Gyro. 2. Select a sensor to be connected to the serial port for Gyro from the [Sensor] combo box. When not selecting a sensor, set [-]. 	To enable: Select. To disable: Clear.
LOG	<ol style="list-style-type: none"> 1. Select the check box and enable the serial port for the LOG. 2. Select a sensor to be connected to the serial port for LOG from the [Sensor] combo box. When not selecting a sensor, set [-]. 	To enable: Select. To disable: Clear.
GPS	<ol style="list-style-type: none"> 1. Select the check box and enable the serial port for the GPS. 2. Select a sensor to be connected to the serial port for the GPS from the [Sensor] combo box. When not selecting a sensor, set [-]. 	To enable: Select. To disable: Clear.
AIS	<ol style="list-style-type: none"> 1. Select the check box and enable the serial port for the AIS. 2. Select a sensor to be connected to the serial port for the AIS from the [Sensor] combo box. When not selecting a sensor, set [-]. 	To enable: Select. To disable: Clear.

Table A: Sensors that can be selected by serial ports on CCU

Serial port	Sensor name
Gyro	Heading Sensor(NMEA), Heading Sensor1(NMEA) ^{*1} , Heading Sensor2(NMEA) ^{*1}
	Heading Sensor(Gyro I/F), Heading Sensor1(Gyro I/F) ^{*1} , Heading Sensor2(Gyro I/F) ^{*1}
LOG	Log(NMEA), Log1(NMEA) ^{*2} , Log2(NMEA) ^{*2}
	Log(Gyro I/F) ^{*3}
	Selector
GPS	GPS 1
	GPS 2 ^{*4}
	GPS 3 ^{*4}
	GPS 4 ^{*4}
	Selector
AIS	AIS

*1: Only when two heading sensors are available.

*2 : Only when two logs are available

*3 : Only when Heading Sensor(Gyro I/F) is selected for Gyro of CCU

*4 : May not be displayed depending on the number of GPS units

Setting serial ports on SLC/ALC

Set the serial ports on SLC/ALC that is installed as follows.

Setting item	Setting contents	Setting value
CH1 to CH8 (RS-422)	<ol style="list-style-type: none"> 1. Click on any of the tabs, SLC1(M) to SLC4(M)/SLC1(S) to SLC4(S)/ALC1 to ALC4. 2. Enable the serial port of the channel by selecting the check box. 3. Select a sensor*1 to be connected to the channel on the [Sensor] combo box. When not selecting a sensor, select [-]. 	Enable: Selected Disable: Clear
CH9/CH10 (RS-422/RS485)	<ol style="list-style-type: none"> 1. Click on any of the tabs, SLC1(M) to SLC4(M)/SLC1(S) to SLC4(S)/ALC1 to ALC4. 2. Enable the serial port of the channel by selecting the check box. 3. Select a sensor*1 to be connected to the channel on the [Sensor] combo box. When not selecting a sensor, select [-]. 	Enable: Selected Disable: Clear

*1: The sensors that can be selected on SLC/ALC are indicated below.

However, the sensors that can be actually selected vary depending on the equipment setting.

Heading Sensor 1, Heading Sensor 2, Log 1, Log 2, GPS 1, GPS 2, GPS 3, GPS 4, Ship's Clock, Echo Sounder(Depth), Echo Sounder2(Depth), AIS, NAVTEX, Anemometer(Wind), Water Temperature Meter, Current Meter, Climate Meter, TRI, Autopilot, Rudder, Engine/Propeller, Engine Telegraph, Thruster, Azimuth Thruster, Generator, Fin Stabilizer, YEOMAN Digitizer, RADAR1(TT RX), Gyro Switch, RADAR2(TT RX), Alert(to CAM), Alert(from Subsystem), Alert(to BNWAS), DSC, IAS(MODBUS), IAS(NMEA), NAV/Alert, Plotter, GPS Buoy

17.3.3.4 To change the communication settings of the Serial Port

Click the [Detail] button of the enabled serial port and display the [Detail] dialog.

Serial Port - Detail

Source Device SLC1 Sensor Anemometer(Wind)

Terminal CH1

Communication

Baud Rate 4800 Stop Bits 1 Checksum

Data Length 8 Buffer Size 256

Parity None Time Out 15 sec

Alert(from Sensor)

Sentence -

Set

When selecting CH1 to CH7

Serial Port - Detail

Source Device SLC1 Sensor TRI

Terminal CH8

Communication

Baud Rate 4800 1.5% Stop Bits 1 Checksum

Data Length 8 Buffer Size 256

Parity None Time Out 15 sec

Alert(from Sensor)

Sentence -

Set

When selecting CH8 to CH10

The setting target can be checked with [Source Device] display, [Terminal] display and [Sensor] display.

Perform the settings shown in the following table and then click on the [Set] button.

Setting Item	Description of Setting	Setting Value
Baud Rate	Select the baud rate of the serial port on the combo box. In the [Detail] dialog of any of CH8 to CH10, the [Baud Rate] addition ratio combo box is displayed on the right side of the [Baud Rate] combo box.	Selectable baud rates vary depending on the serial port (refer to "Selectable baud rates").
[Baud Rate] addition ratio combo box	Displayed in the [Detail] dialog of CH8 to CH10. By using this combo box, the addition ratio (%) for adjusting the baud rate can be changed. The baud rate is determined by adding the additional ratio to the value that is set in the [Baud Rate] combo box. Example) $4800 \times (1 + 1.5 / 100) = 4872$ Additional ratio	0.0% to 3.0% (can be set in the unit of 0.5%)
Data Length	Select the data length of the corresponding serial port from the combo box.	5/6/7/8
Parity	Select the parity of the corresponding serial port from the combo box.	None/Odd/Even
Stop Bits (Stop Bit Length)	Select the stop bit length of the corresponding serial port from the combo box.	1/2
Buffer Size	Enter the buffer size of the corresponding serial port from the list.	0 to 10240 byte
Time Out	Enter the time-out duration of the corresponding serial port from the list.	0 to 999s
Checksum	Select the check box and enable the checksum of the sentence of the corresponding serial port.	To enable: Select. To disable: Clear.
Subsystem	Set the equipment to be connected for Alert Handling. Displayed only when the sensor is "Alert (from Subsystem)" or "Alert (to CAM)". The selection is also allowed for the subsystem that has already been used in the channel of some other serial port.	"Alert (from Subsystem)": Equipment that is set as -/installed (Task Station and sensor) "Alert(to CAM)": Equipment that is set as -/installed (Task Station)
Primary/Secondary	Select Primary or Secondary for IAS (MODBUS) input. Displayed only when the sensor is "IAS(MODBUS)".	Primary: Primary system Secondary: Secondary system
Sentence	Select the sentence of Alert Handling. Displayed when the sensor is other than "Alert (BNWAS)", "IAS(MODBUS)", or "DSC" or "NAV/Alert".	Normal sensor such as GPS and Log: -/ALR/ALF "Alert (from Subsystem/to CAM)": ALR/ALF

Selectable baud rates

Serial port	Baud rate
Serial point on CCU	
Gyro (at selection of Heading Sensor(NMEA))	4800/38400
Gyro (at selection of Heading Sensor(Gyro I/F))	Fixed to 38400
Log (at selection of Log(NMEA))	Fixed to 4800
Log (at selection of Log(Gyro I/F))	Fixed to 38400
GPS	Fixed to 4800
AIS	Fixed to 38400
Serial port on SLC/ALC	
CH1-8	2400/4800/9600
CH9/10	2400/4800/9600/19200/38400
Gyro I/F	Fixed to 38400

17.3.4 Setting a System Function

Verify the setting of the system function of this equipment and perform initial setting by using the [System Function] dialog.

17.3.4.1 Displaying a [System Function] dialog

When you select [System Configuration] in the first classification pane and [System Function] in the second classification pane, the [System Function] dialog is displayed in the edit/result pane.

Equipment	Connection	System Function	SFI		Cluster	Control		Alert		
			Talker	No.		Tx		Tx	Rx	
<input type="checkbox"/> No.1 RADAR	LAN	RADAR	RA	0002	Nav	TGTD	●	TGTD	CAM1	●
<input type="checkbox"/> No.2 RADAR	LAN	RADAR	RA	0003	Nav	TGTD	●	TGTD	CAM1	●
<input type="checkbox"/> No.1 ECDIS	LAN	ECDIS	EI	0004	Nav	NAVD	●	NAVD	CAM1	●
<input type="checkbox"/> No.1 ECDIS	LAN	Track Cont...	TC	0004	Nav	NAVD	●	NAVD	CAM1	●
<input type="checkbox"/> No.2 ECDIS	LAN	ECDIS	EI	0005	Nav	NAVD	●	NAVD	CAM1	●
<input type="checkbox"/> No.1 CON	LAN	CONNING	II	0001	Nav	MISC	○	MISC	CAM1	○
<input type="checkbox"/> VDR	LAN	VDR	VR	0001	Nav	MISC	●	MISC	CAM1	●
<input type="checkbox"/> Heading Sensor 1	SLC(Main)	Heading	HE	0003	Nav	SATD	●	SATD	CAM1	●
<input type="checkbox"/> Heading Sensor 1	CCU	Heading	---	---	---	---	●	---	---	●
<input type="checkbox"/> Log 1	SLC(Main)	Log	VD	0002	Nav	NAVD	●	NAVD	CAM1	●
<input type="checkbox"/> Log 1	CCU	Log	---	---	---	---	●	---	---	●
<input type="checkbox"/> GPS 1	SLC(Main)	GPS	GP	0001	Nav	NAVD	●	NAVD	CAM1	●
<input type="checkbox"/> GPS 1	CCU	GPS	---	---	---	---	●	---	---	●
<input type="checkbox"/> GPS 2	SLC(Main)	GPS	GP	0006	Nav	NAVD	●	NAVD	CAM1	●
<input type="checkbox"/> Echo Sounder 1(T/...	SLC(Main)	Depth	SD	0004	Nav	NAVD	●	NAVD	CAM1	●
<input type="checkbox"/> AIS	SLC(Main)	AIS	AI	0009	Nav	TGTD	●	TGTD	CAM1	●
<input type="checkbox"/> AIS	CCU	AIS	---	---	---	---	●	---	---	●
<input type="checkbox"/> NAVTEX	SLC(Main)	NAVTEX	CR	0007	Nav	RCOM	●	RCOM	CAM1	●
<input type="checkbox"/> Current Meter	SLC(Main)	Weather	WI	0010	Nav	NAVD	●	NAVD	CAM1	●
<input type="checkbox"/> Autopilot	SLC(Main)	Autopilot	AG	0008	Nav	NAVD	●	NAVD	CAM1	●
<input type="checkbox"/> Engine/Propeller	SLC(Main)	Engine/Pro...	ER	0005	Nav	MISC	●	MISC	CAM1	●
<input type="checkbox"/> SLC 1(Main)	LAN	SNGF	SI	0013	Nav	MISC	●	MISC	CAM1	●

17.3.4.2 Lamp light colors

- The lamp of control indicates the Diagnosis result on whether or not the data of control of the specified for each equipment has been received successfully.
- The lamp of alert indicates the Diagnosis result on whether or not the data of Alert of the specified for each equipment has been received successfully.

Lit in red: Data not received.

Lit in green: Data is receiving.

Lit in orange: In Diagnosis (before decision).

No color: System function is disabled.

17.3.4.3 Setting a system function

In the [System Function] dialog, allocate the system functions to be connected for LAN.

Add a system function (New equipment)

Click the [Add] button and display the [System Function (Add)] dialog.

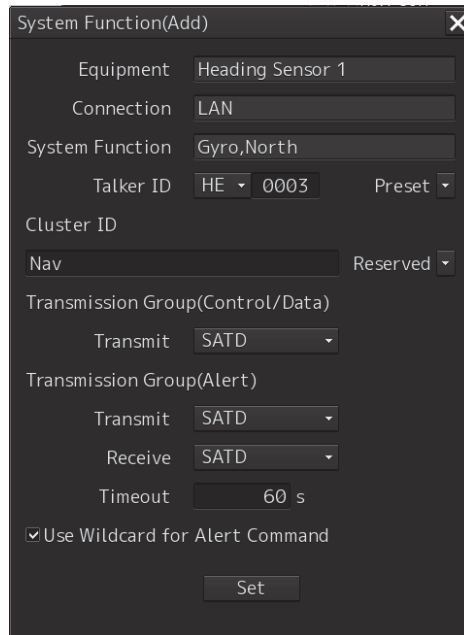

Perform the settings shown in the following table and then click on the [Set] button.

Setting Item		Description of Setting	Setting Value
Equipment		Select an Equipment ^{*1} on the combo box. In the case of "Add a system function (Existing equipment)", equipment can not be changed.	The Equipment that can be actually selected vary depending on the installation setting.
Talker ID ^{*6}	Mnemonic	Select the Mnemonic ^{*2} of Talker ID on the combo box.	The Mnemonic of Talker ID vary depending on the equipment.
	Instance No	Enter the Instance No of Talker ID.	0001 to 9999 The Instance No of Talker ID vary depending on the equipment.
Cluster ID		Enter the Cluster ID ^{*3} . It can also be set by selecting Equipment on the Reserved combo box. In the case of "Edit a system function", Cluster ID can not be changed.	Nav/Com/Aut/Cgo/Htl/ICT/SSe/Pos/.ROV
Transmission Group ^{*6} (Control/Data)		Select the Transmission Group ^{*4} for Control/Data.	The Transmission Group (Control/Data) vary depending on the equipment.
Transmission Group (Alert)	Transmit ^{*6}	Select the Transmission Group ^{*4} of Transmit for Alert.	The Transmission Group (Alert) vary depending on the equipment. ^{*5}
	Receive ^{*6}	Select the Transmission Group ^{*4} of Receive for Alert.	CAM1 ^{*5}
	Timeout	Enter the time-out duration.	0 to 120s (Default: 60s)
Use Wildcard for Alert Command		Select the check box and enable the Use Wildcard for Alert Command.	To enable: Select (Default) To disable: Clear

*1: The Equipment that can be selected are indicated below.

However, the equipment that can be actually selected vary depending on the installation setting.

Heading Sensor 1, Heading Sensor 2, Gyro Switch, Log 1, Log 2, GPS 1, GPS 2, GPS 3, GPS 4, Ship's Clock, Echo Sounder1(T/D 1, T/D2), Echo Sounder2(T/D 3), AIS, NAVTEX, Anemometer 1, Water TEMP Meter, Current Meter, Climate Meter, ROT Indicator, Autopilot, Rudder, Engine/Propeller, Engine Telegraph, Thruster, Azimuth Thruster, Generator, S-JOY/Joystick 1~5, BNWAS, General Equipment(Alert)1~10, GPS Buoy, Plotter, DSC, IAS, CAM, NAV/Alert, RADAR1,RADAR2, VDR

Note:

IAS and NAVTEX: Only NMEA is supported.

CAM is settings for connecting to an external CAM by LAN.

*2: The Mnemonic of Talker ID that can be selected are indicated below.

AG, AI, BN, CA, CR, EI, ER, GP, HC, HE, II, JA, JB, JC, JD, JE, JF, JG, JH, RA, SD, SG, SI, SS, TC, TI, U0, U1, U2, U3, U4, U5, U6, U7, U8, U9, VD, VR, WI, ZA

*3: Clusters are groups of functionalities aimed at a responsible operator, which can be distributed over systems. Cluster ID is the identifier of the Cluster.

Set the Cluster ID to "Nav" for equipment in the navigation-bridge cluster. If CAM need category C alert from another cluster group, set the Cluster ID according to the transmission specifications of the equipment. Cluster ID can be set any string of a maximum of 15 characters. Cluster ID that equipment is task station is Nav and cannot be changed. The cluster ID that can be selected are indicated below.

Cluster ID	Cluster group
Nav	Navigation
Com	Communication
Aut	Automation
Cgo	Cargo
Htl	Hotel
ICT	ICT
SSe	Safety/Security
Pos	Position control
ROV	Remote operated vehicle

*4: The Transmission Group that can be selected are indicated below.

Transmission Group	IP Address	Port number
MISC	239.192.0.1	60001
TGTD	239.192.0.2	60002
SATD	239.192.0.3	60003
NAVD	239.192.0.4	60004
VDRD	239.192.0.5	60005
RCOM	239.192.0.6	60006
TIME	239.192.0.7	60007
PROP	239.192.0.8	60008
USR1	239.192.0.9	60009
USR2	239.192.0.10	60010
USR3	239.192.0.11	60011
USR4	239.192.0.12	60012
USR5	239.192.0.13	60013
USR6	239.192.0.14	60014
USR7	239.192.0.15	60015
USR8	239.192.0.16	60016
BAM1	239.192.0.17	60017
BAM2	239.192.0.18	60018
CAM1	239.192.0.19	60019
CAM2	239.192.0.20	60020
NETA	239.192.0.56	60056

*5: BAM1/BAM2 and CAM1/CAM2 are available for system integrators to balance the traffic, for example higher volume radar in BAM1/CAM1 and low volume sensor, for example gyro, in BAM2/CAM2.

Equipment	Connection	System Function	SFI		Cluster	Control		Alert		
			Talker	No.		Tx		Tx	Rx	
No.1 RADAR	LAN	RADAR	RA	0001	Nav	TGTD		BAM1	CAM1	
Heading Sensor 1	LAN	Gyro,North	HE	0003	Nav	SATD		BAM2	CAM2	

*6: Talker ID Mnemonic, Talker ID Instance No, Transmission Group (Control/Data), Transmission Group (Alert) Transmit and Transmission Group (Alert) Receive can also be set by selecting Equipment on the preset combo box. The following default values will be set.

Equipment	System Function	TalkerID Mnemonic	TalkerID Instance No	Transmission Group (Control/Data)	Transmission Group (Alert) Transmit	Transmission Group (Alert) Receive
RADAR	RADAR	RA	(TaskStationNo.)	TGTD	TGTD	CAM1
ECDIS	ECDIS	EI	(TaskStationNo.)	NAVD	NAVD	CAM1
CONNING	CONNIN G	II	(TaskStationNo.)	MISC	MISC	CAM1
AMS	CAM	CA	(TaskStationNo.)	CAM1	CAM1	CAM1
TCS	TrackCo ntrol	TC	(TaskStationNo.)	NAVD	NAVD	CAM1
Heading Sensor 1	Heading	HE	0001	NAVD	NAVD	CAM1
Heading Sensor 2	Heading	HE	0002	NAVD	NAVD	CAM1
Gyro Switch	Heading	HE	0001	NAVD	NAVD	CAM1
Log 1	Log	VD	0001	NAVD	NAVD	CAM1
Log 2	Log	VD	0002	NAVD	NAVD	CAM1
GPS 1	GPS	GP	0001	NAVD	NAVD	CAM1
GPS 2	GPS	GP	0002	NAVD	NAVD	CAM1
GPS 3	GPS	GP	0003	NAVD	NAVD	CAM1
GPS 4	GPS	GP	0004	NAVD	NAVD	CAM1
Ship's Clock	Clock	ZA	0001	TIME	TIME	CAM1
Echo Sounder1(T/D 1, T/D2)	Depth	SD	0001	NAVD	NAVD	CAM1
Echo Sounder2(T/D 3)	Depth	SD	0002	NAVD	NAVD	CAM1
AIS	AIS	AI	0001	TGTD	TGTD	CAM1
NAVTEX	NAVTEX	CR	0001	RCOM	RCOM	CAM1
Anemometer 1	Weather	WI	0001	NAVD	NAVD	CAM1
Water TEMP Meter	Weather	WI	0001	NAVD	NAVD	CAM1
Current Meter	Weather	WI	0001	NAVD	NAVD	CAM1
Climate Meter	Weather	WI	0001	NAVD	NAVD	CAM1
ROT Indicator	TRI	TI	0001	SATD	SATD	CAM1
Autopilot	Auto Pilot	AG	0001	NAVD	NAVD	CAM1
Rudder	Rudder	SG	0001	MISC	MISC	CAM1
Engine/Propeller	Engine/P ropeller	ER	0001	MISC	MISC	CAM1
Engine Telegraph	Engine Telegraph	ER	0001	MISC	MISC	CAM1
Thruster	Thruster	ER	0001	MISC	MISC	CAM1
Azimuth Thruster	Azimuth Thruster	ER	0001	MISC	MISC	CAM1
Generator	Generato r	ER	0001	MISC	MISC	CAM1
S-JOY/Joystick	S-JOY/J oystick	SG	0001	MISC	-	-
BNWAS	BNWAS	BN	0001	-	VDRD	CAM1
General Equipment(Alert) 1	General 1	U0	0001	-	MISC	CAM1
General Equipment(Alert) 2	General 2	U0	0002	-	MISC	CAM1
General	General	U0	0003	-	MISC	CAM1

Equipment	System Function	TalkerID Mnemonic	TalkerID Instance No	Transmission Group (Control/Data)	Transmission Group (Alert) Transmit	Transmission Group (Alert) Receive
Equipment(Alert) 3	3					
General Equipment(Alert) 4	General 4	U0	0004	-	MISC	CAM1
General Equipment(Alert) 5	General 5	U0	0005	-	MISC	CAM1
General Equipment(Alert) 6	General 6	U0	0006	-	MISC	CAM1
General Equipment(Alert) 7	General 7	U0	0007	-	MISC	CAM1
General Equipment(Alert) 8	General 8	U0	0008	-	MISC	CAM1
General Equipment(Alert) 9	General 9	U0	0009	-	MISC	CAM1
General Equipment(Alert) 10	General 10	U0	0010	-	MISC	CAM1
GPS Buoy	GPS	GP	0001	NAVD	NAVD	CAM1
Plotter	GPS	GP	0001	NAVD	NAVD	CAM1
DSC	DSC	U1	0001	-	MISC	CAM1
IAS	IAS	JE	0001	MISC	MISC	CAM1
CAM	CAM	CA	0001	CAM1	CAM1	CAM1
NAV/Alert	NAV/Alert	ER	0001	MISC	-	-
RADAR1	RADAR	RA	0001	TGTD	-	-
RADAR2	RADAR	RA	0002	TGTD	-	-
VDR	VDR	VR	0001	MISC	MISC	CAM1
SLC 1(Main)	SNGF	SI	0013	MISC	-	-
SLC 2(Main)	SNGF	SI	0113	MISC	-	-
SLC 3(Main)	SNGF	SI	0213	MISC	-	-
SLC 4(Main)	SNGF	SI	0313	MISC	-	-
SLC 1(Sub)	SNGF	SI	0063	MISC	-	-
SLC 2(Sub)	SNGF	SI	0163	MISC	-	-
SLC 3(Sub)	SNGF	SI	0263	MISC	-	-
SLC 4(Sub)	SNGF	SI	0363	MISC	-	-
ALC 1	SNGF	SI	1213	MISC	-	-
ALC 2	SNGF	SI	1313	MISC	-	-
ALC 3	SNGF	SI	1413	MISC	-	-
ALC 4	SNGF	SI	1513	MISC	-	-

Add a system function (Existing equipment)

Select the check box and Click the [Add] button and display the [System Function (Add)] dialog.

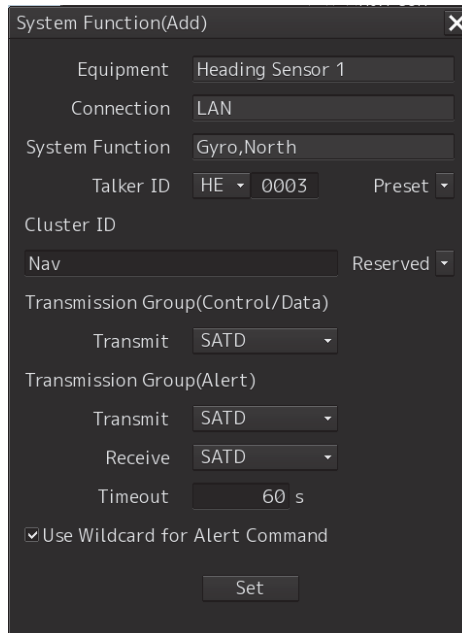

The screenshot shows the 'System Function(Add)' dialog box. It contains the following fields and options:

- Equipment: Heading Sensor 1
- Connection: LAN
- System Function: Gyro,North
- Talker ID: HE (dropdown), 0003, Preset (dropdown)
- Cluster ID: Nav (dropdown), Reserved (dropdown)
- Transmission Group(Control/Data): Transmit (dropdown), SATD
- Transmission Group(Alert): Transmit (dropdown), SATD; Receive (dropdown), SATD
- Timeout: 60 s
- Use Wildcard for Alert Command
- Set button

Perform the settings referring to **Add a system function (New equipment)**. Equipment can not be changed on the [Detail] dialog.

Edit a system function

Select the check box and click the [Edit] button and display the [System Function (Edit)] dialog.

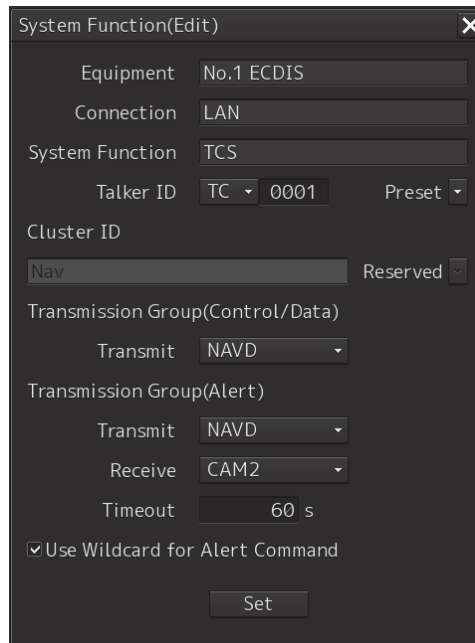

The screenshot shows the 'System Function(Edit)' dialog box. It contains the following fields and options:

- Equipment: No.1 ECDIS
- Connection: LAN
- System Function: TCS
- Talker ID: TC (dropdown), 0001, Preset (dropdown)
- Cluster ID: Nav (dropdown), Reserved (dropdown)
- Transmission Group(Control/Data): Transmit (dropdown), NAVD
- Transmission Group(Alert): Transmit (dropdown), NAVD; Receive (dropdown), CAM2
- Timeout: 60 s
- Use Wildcard for Alert Command
- Set button

Perform the settings referring to **Add a system function (New equipment)**. Cluster ID can not be changed on the [Detail] dialog.

Delete a system function

Select the check box and click the [Delete] button. Selected a system function is deleted.

Note:

- Set the each setting according to the transmission specifications of the equipment connected to the LAN.
- Equipment connected to the SLC / ALC serial port or CCU cannot add or edit or delete system functions. System function of Equipment connected to the SLC / ALC serial port or CCU are registered automatically by serial port setting on [Serial Port] dialog.
- The native system function of VDR, No.x RADAR, ECDIS, CON, MFD, RPS can not delete on [System Function] dialog..

17.3.5 Setting Ship's Parameters

Set parameter values of own ship by using the [Ship's Parameters] dialog.

17.3.5.1 Displaying the [Ship's Parameters] dialog

When you select [Ship's Parameters] in the classification pane, the [Ship's Parameters] dialog is displayed in the edit/result pane.

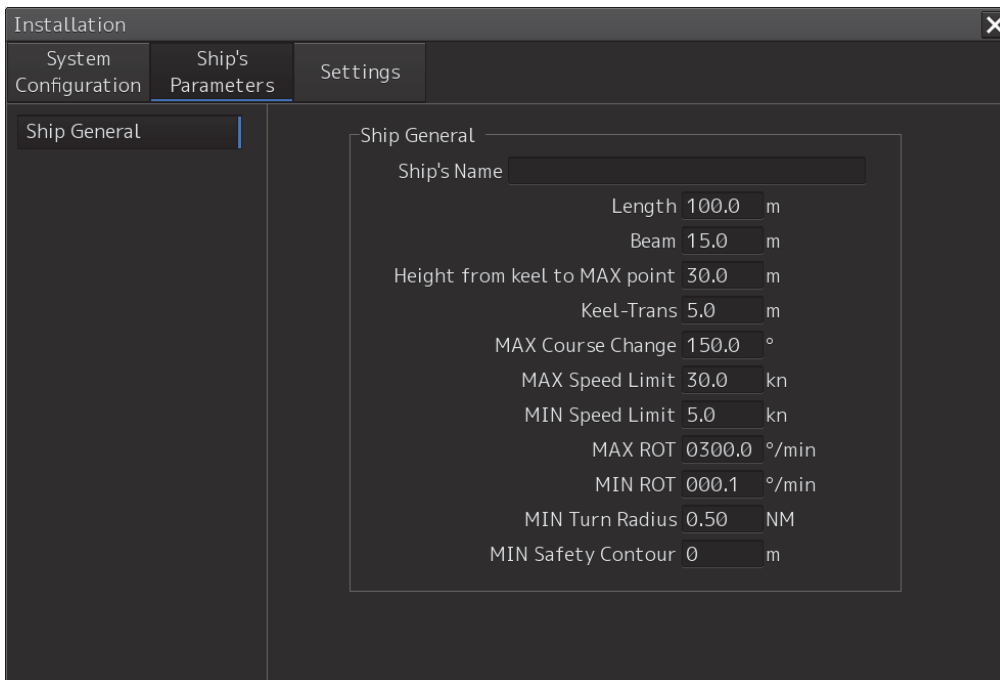

17.3.5.2 Setting own ship's parameters

Set the following items in the [Ship's Parameters] dialog.

Setting Item	Description of Setting	Setting Value
Ship's Name	Enter own ship's name in the box.	Max. 20 characters
Length (of ship)	Enter own ship's length in the box.	1.0 to 1022.0 m
Beam (ship's width)	Enter own ship's beam in the box.	1.0 to 126.0 m
Height from keel to MAX point	Enter the height of the ship from the keel to the maximum point in the box.	1.0 to 126.0 m
Keel-Trans (distance between the transducer and the keel)	Enter the distance between the transducer of the depth sounder and the keel. (Required when displaying the water depth with the keel fixed)	0.0 to 20.0 m
MAX Course Change (limit value of course change angle)	Enter the limit value of the course change angle of the planned route in the box.	20.0 to 359.9°
MAX Speed Limit	Enter the ship's maximum speed in the box.	10.0 to 99.9 kn
MIN Speed Limit	Enter the ship's minimum speed in the box.	0.0 to 89.9 kn
MAX ROT	Enter the maximum rate of turn in the box.	30.0 to 600.0°/min
MIN ROT	Enter the minimum rate of turn in the box.	0.0 to 570.0°/min
MIN Turn Radius	Enter the minimum turn radius in the box.	0.00 to 9.99 NM
MIN Safety Contour (Minimum value of SafetyContour that can be set)	Enter the minimum value of SafetyContour in the box.	0 to 200 m

Note

When the MIN Safety Contour is set greater than the value of the Safety Contour already set, the value of the MIN Safety Contour is used as the Safety Contour. When it set the MIN Safety Contour, please confirm the setting of the Safety Contour. The Safety Contour can be set from Page2 of [Menu]-[View]-[Options]-[Chart Common].

Synchronizing setting

The [Ship's Parameters] dialog enables common setting items and individual setting items for RADAR, ECDIS, and Conning (called a task station individually). Once common items are set in any of the task stations, RADAR, ECDIS, and Conning, the settings are reflected (synchronized) in other task stations. By setting common items in the state where all the task stations are active, the common setting items are synchronized in all the task stations.

17.3.6 Setting the automatic sailing system

Note

In case of JAN-7201S/9201S, automatic sailing function is not available by function restriction.
Therefore the setup is not available.

By using the [Autosail] dialog, verify and initialize the automatic sailing system that is installed in this equipment.

17.3.6.1 Displaying the [Autosail] dialog

When you select [Settings] in the first classification pane and [Autosail] in the second classification pane, the [Autosail] dialog is displayed in the edit/result pane.

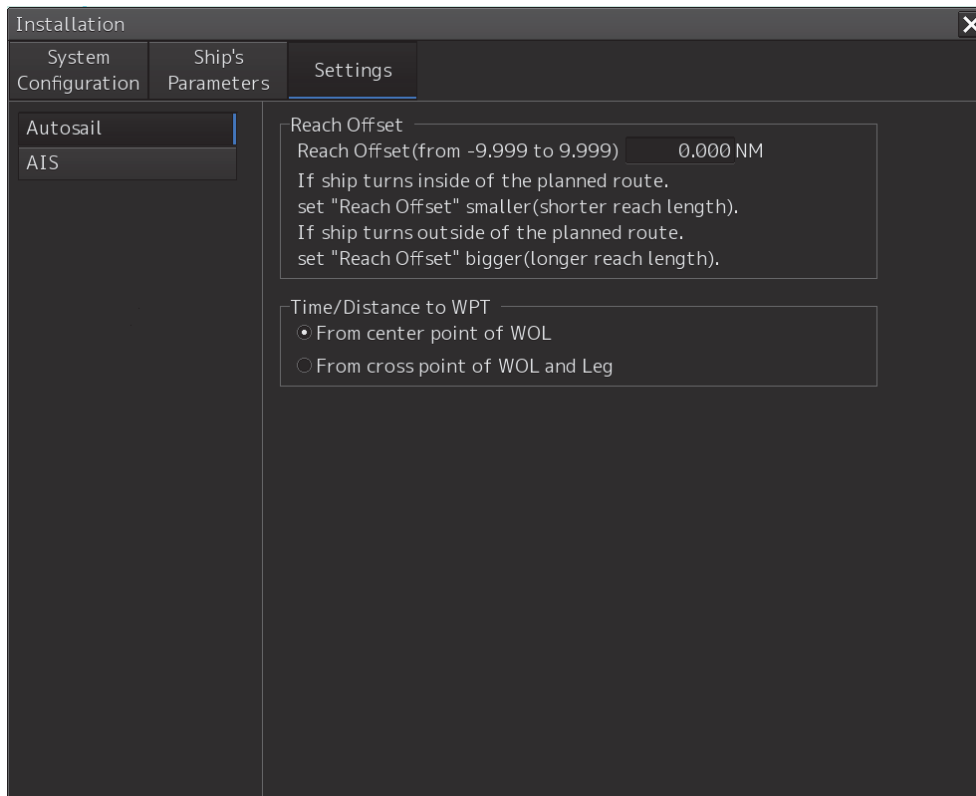

17.3.6.2 Setting the automatic sailing system

Set the following items in the [Autosail] dialog.

Setting Item	Description of Setting	Setting Value
Reach Offset	Enter the reach offset in the box.	-9.999 to 9.999 NM
Time/Distance to WPT	Select this to select a parameter for calculating the time and distance from own ship to the WPT. From center point of WOL: Center point between own ship and the WOL From cross point of WOL and Leg: Center point of own ship's heading and the WOL	<ul style="list-style-type: none">• From center point of WOL• From cross point of WOL and Leg

17.3.7 Setting the AIS password

Set the AIS password by using the [AIS] dialog.

17.3.7.1 Displaying the [AIS] dialog

When [Settings] is selected in the 1st classification pane and [AIS] is selected in the 2nd classification pane, the [AIS] dialog is displayed in the edit/result pane.

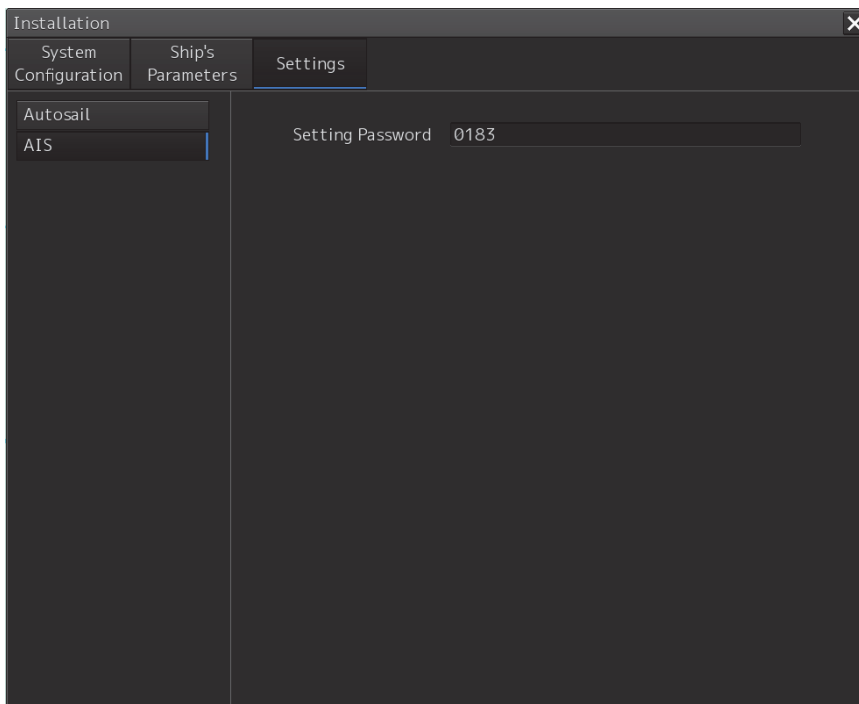

17.3.7.2 Setting the AIS password

Set the following item on the [AIS] dialog.

Setting item	Description of setting	Setting value
Setting Password	To change Voyage data from the external device, JHS-183 requires the password. When the AIS password is changed, change this setting value. When the password is not required, this setting value is ignored in (JHS-182).	Up to 32 characters (numeric value only)

17.3.8 Setting Sensor

The alert set point (Alarm Limit) display and GPS switching interlocking function can be set for depth display on the “Sensor” dialog.

17.3.8.1 Displaying the [Sensor] dialog

When [Settings] is selected in the 1st classification pane and [Sensor] is selected in the 2nd classification pane, the [Sensor] dialog is displayed in the edit/result pane.

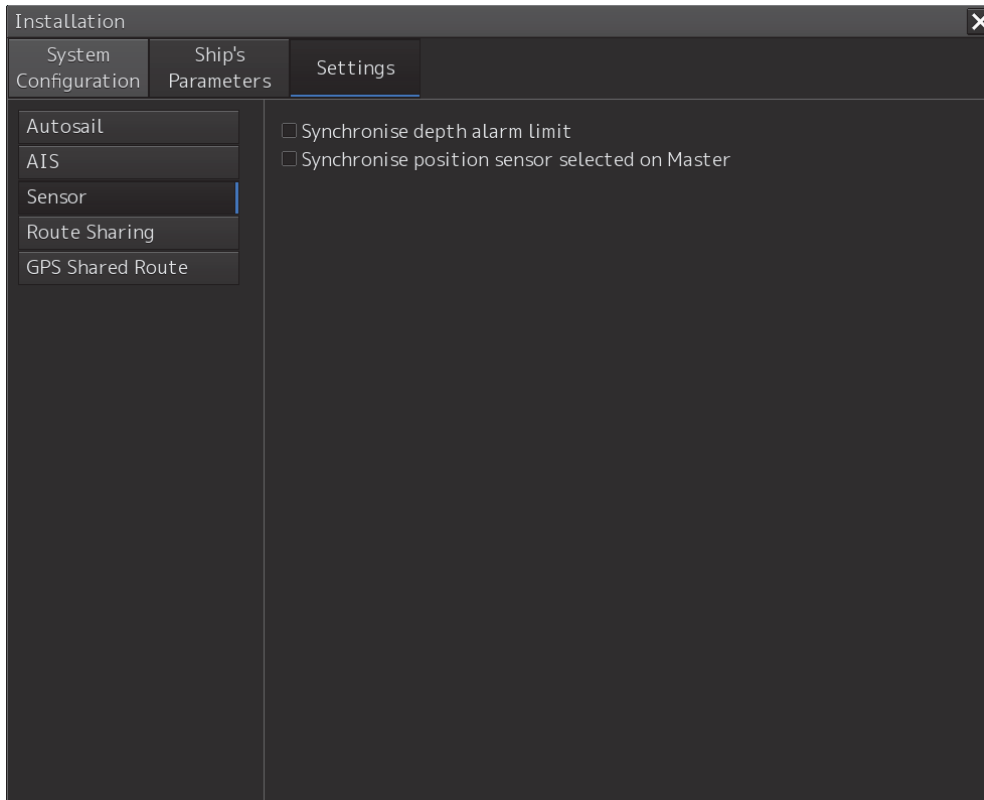

17.3.8.2 Displaying an alert set point

Check the [Synchronise depth alarm limit] check box.

The depth that is set in [Depth below keel Alarm] of the [Depth/Safety Contour] dialog of the “Alert” menu is displayed as the alarm set point (Alarm Limit). Subsequently, the setting value of [Depth below keel Alarm] is fixed and the value can no longer be changed.

To reset the alarm set point display, uncheck the [Synchronise depth alarm limit] check box.

17.3.8.3 Setting the GPS switching linkage function

Check the [Synchronise position sensor selected Master] check box.

A badge is displayed on the Top screen (own ship's position) of the equipment with the GPS Selector control authorization.

When the GPS switching linkage function is enabled, the GPS sensor source with other equipment is linked.

17.3.9 Setting Route Sharing

In the "Route Sharing" dialog, change the route sharing method used for route sharing.

17.3.9.1 Displaying the [Route Sharing] dialog

When [Settings] is selected in the 1st classification pane and [Route Sharing] is selected in the 2nd classification pane, the [Route Sharing] dialog is displayed in the edit/result pane.

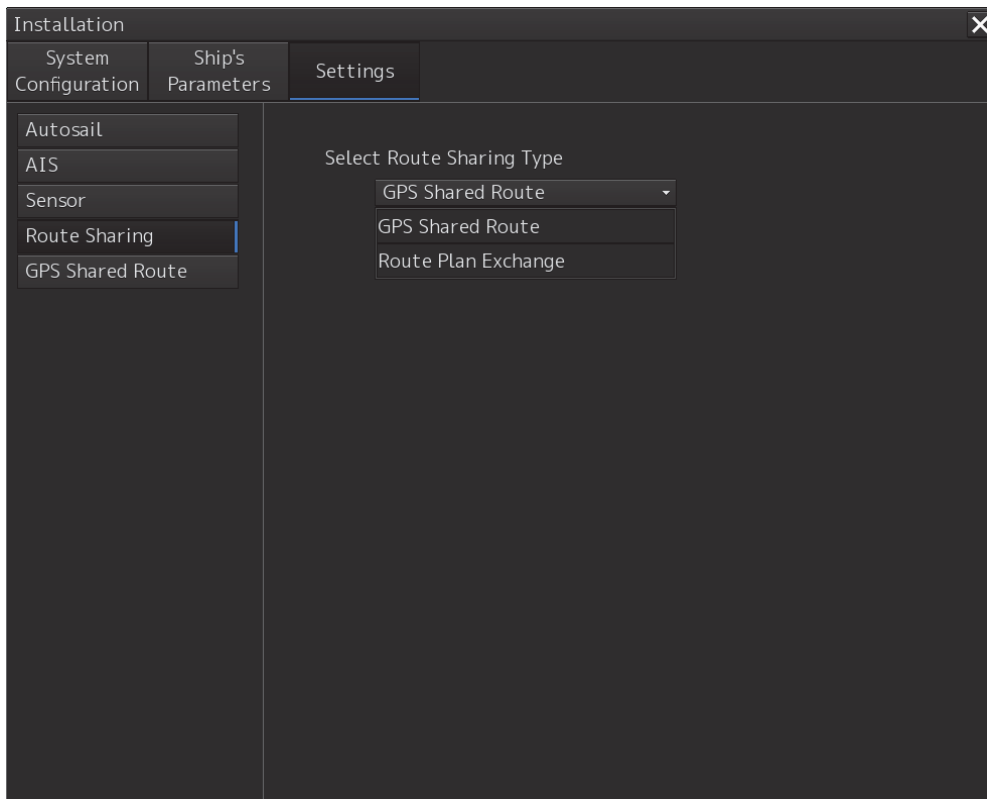

17.3.9.2 Selecting a route sharing method

From the combo box, select the route sharing method to use.

GPS Shared Route

Route Plan Exchange

When selected, the selected item is added to the left pane

17.3.10 Setting the GPS Shared Route

This function enables the switching between new route sharing and old route sharing and the setting of data route transmission/reception to ON/OFF.

17.3.10.1 Displaying the [GPS Shared Route] dialog

When [Settings] is selected in the 1st classification pane and [GPS Shared Route] is selected in the 2nd classification pane, the [GPS Shared Route] dialog is displayed in the edit/result pane.

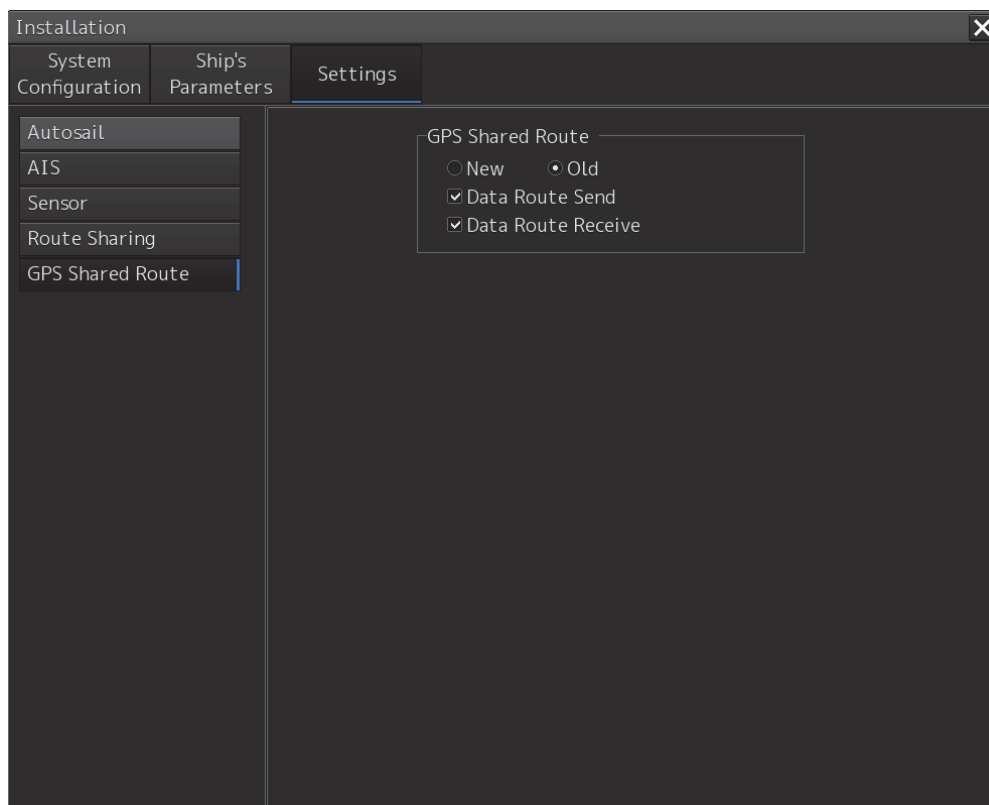

17.3.10.2 Setting the GPS Shared Route

You can switch various settings on and off by checking as shown in the table below. For the INS configuration, the New and Old check boxes are hidden.

Setting item	Setting contents	Setting value
New	Sharing of a new route can be set to On/Off.	On: Default Off
Old	Sharing of an old route can be set to On/Off.	On Off: Default
Data Route Send	Data route transmission can be set to On/Off. On: [Send to GPS] of [Route Planning]-[▼] is enabled. Transmission log is displayed in the Status Log column of the Send to GPS screen. Off: [Send to GPS] of [Route Planning]-[▼] is disabled.	On: Default Off
Data Route Receive	Data route reception can be set to On/Off. On: Reception log is displayed in the Status Log column of the Send to GPS screen. Off: Reception log is not displayed in the Status Log column of the Send to GPS screen.	On: Default Off

17.3.11 Setting the Route Plan Exchange

You can switch the enable / disable of route plan exchange and make various settings.

17.3.11.1 Displaying the [Route Plan Exchange] dialog

When [Settings] is selected in the 1st classification pane and [Route Plan Exchange] is selected in the 2nd classification pane, the [Route Plan Exchange] dialog is displayed in the edit/result pane.

The screenshot shows the 'Installation' dialog box with the 'Settings' tab selected. The 'Route Plan Exchange' section is active, showing the following settings:

- Enable Route Plan Exchange
- Address: 239.192.0.25
- Port: 60025
- Timeout: 15 s

Below these settings is a section titled 'Destination Equipment' with the instruction 'Input the correct SFI of destination.' It contains a table with three rows for 'Equipment 1', 'Equipment 2', and 'Equipment 3'. Each row has a checkbox, an SFI dropdown menu, an SFI input box, and a Transmission Group dropdown menu.

	SFI	Transmission Group
<input checked="" type="checkbox"/> Equipment 1	II 0000	MISC
<input type="checkbox"/> Equipment 2	II 0000	MISC
<input type="checkbox"/> Equipment 3	II 0000	MISC

Below the table, there is a note: 'Set the SFI of Own Task Station into the destination equipments. SFI of Own Task Station is, EI0001'.

17.3.11.2 Setting the Route Plan Exchange

When the **Enable Route Plan Exchange** check box is set to On, the route plan exchange function is enabled.

In the **Address** combo box, you can select the multicast address to be used for route plan exchanges from the following five.

•239.192.0.21 •239.192.0.22 •239.192.0.23 •239.192.0.24 •239.192.0.25

In the **Timeout** input box, you can set the response waiting timeout judgment value in the route plan exchange.

In the **SFI** combo box, you can set two prefix characters that form SFI.

In the **Transmission Groupe** combo box, you can set the transmission group to be specified when sending and receiving.

In **SFI display box of Own Task Station**, its own SFI is displayed.

17.4 Maintenance

Use the [Maintenance] dialog box for maintenance operation of this equipment.

17.4.1 Displaying the [Maintenance] dialog box

Clicking the [Maintenance] button in the submenu displays the [Maintenance] dialog box.

The [Maintenance] dialog box in the submenu consists of the classification pane and the edit/result pane. The classification pane consists of two-level layers of the first classification pane and the second classification pane.

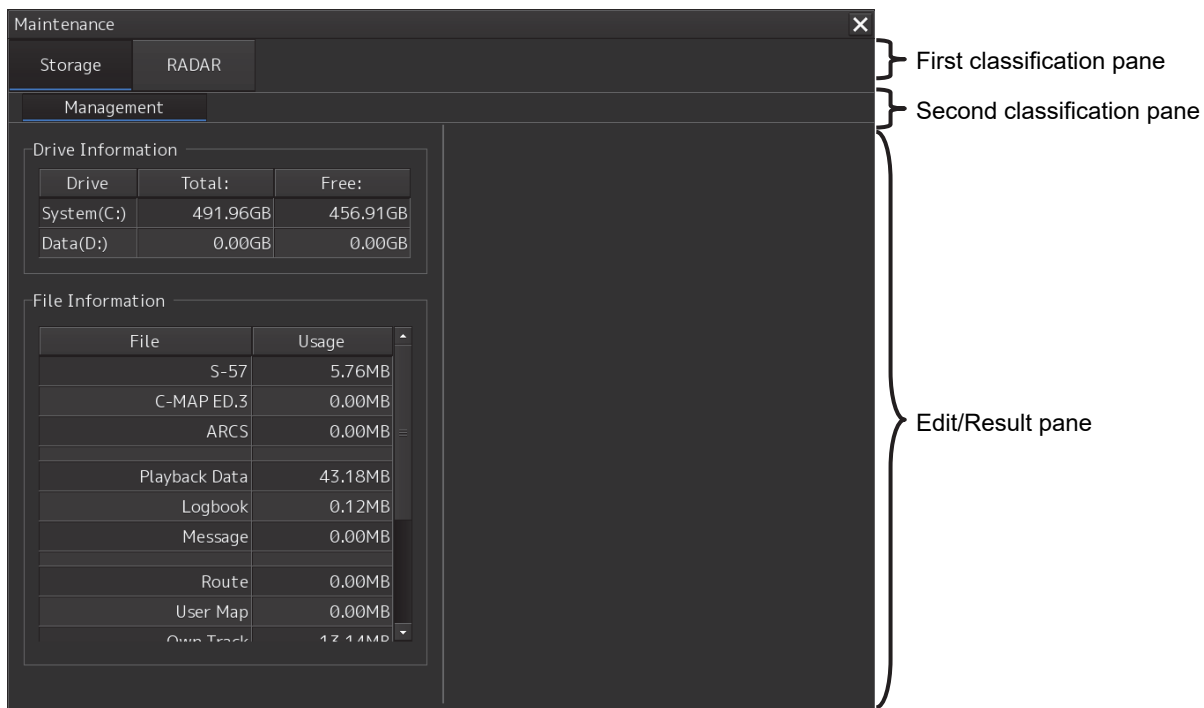

17.4.2 Managing storage

When you select [Storage] in the first classification pane and [Management] in the second classification pane, the [Management] dialog is displayed in the edit/result pane.

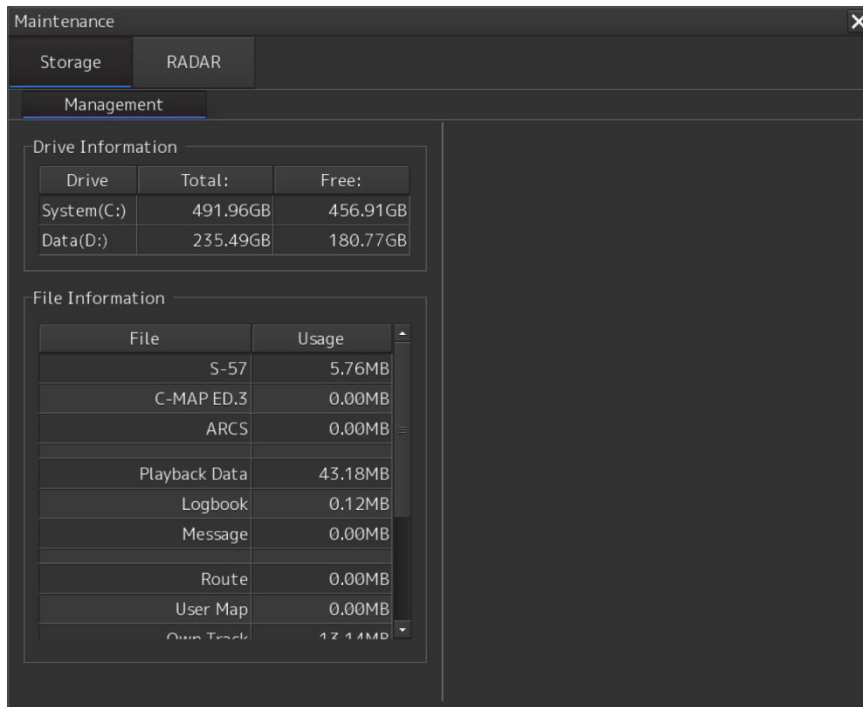

The total storage capacity and free space on each of the drives (C and D) are displayed in the [Drive Information] list. The capacity of each of the files stored on the drives is displayed in the [File Information] list. The files managed by File Manager are applicable.

Section 18 Playing Back Data Recorded During Navigation

The following information recorded during navigation can be played back on the screen.

- Own ship's information
- Other ship's information
- Route information
- Alarm information

Click on the [Playback] button on the Task Menu.

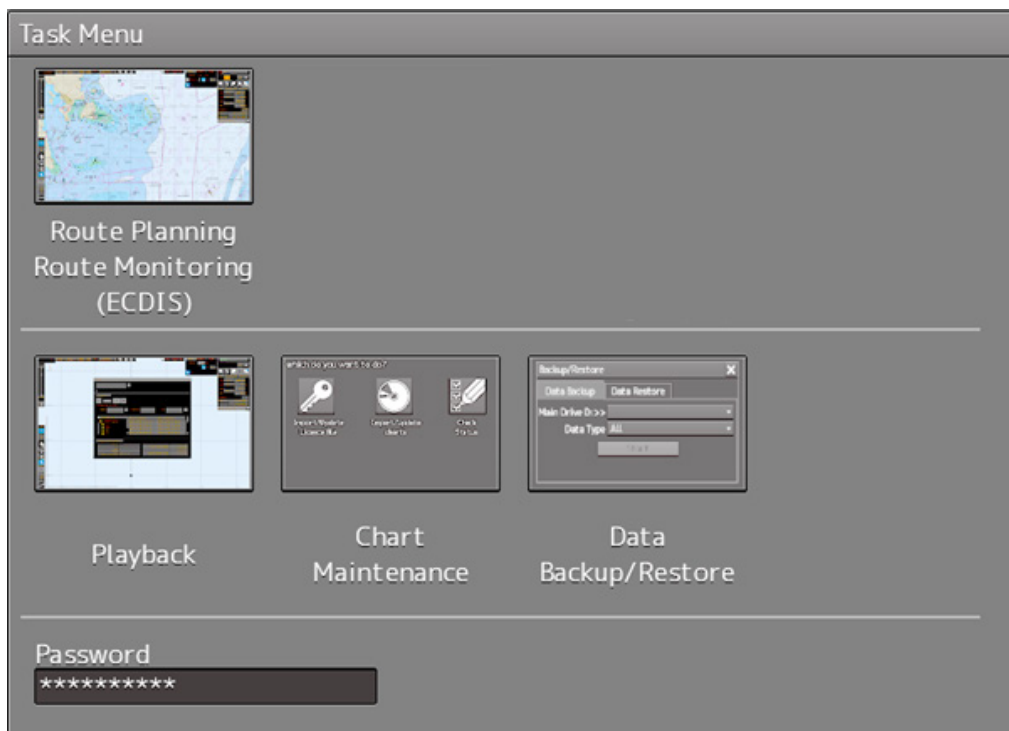

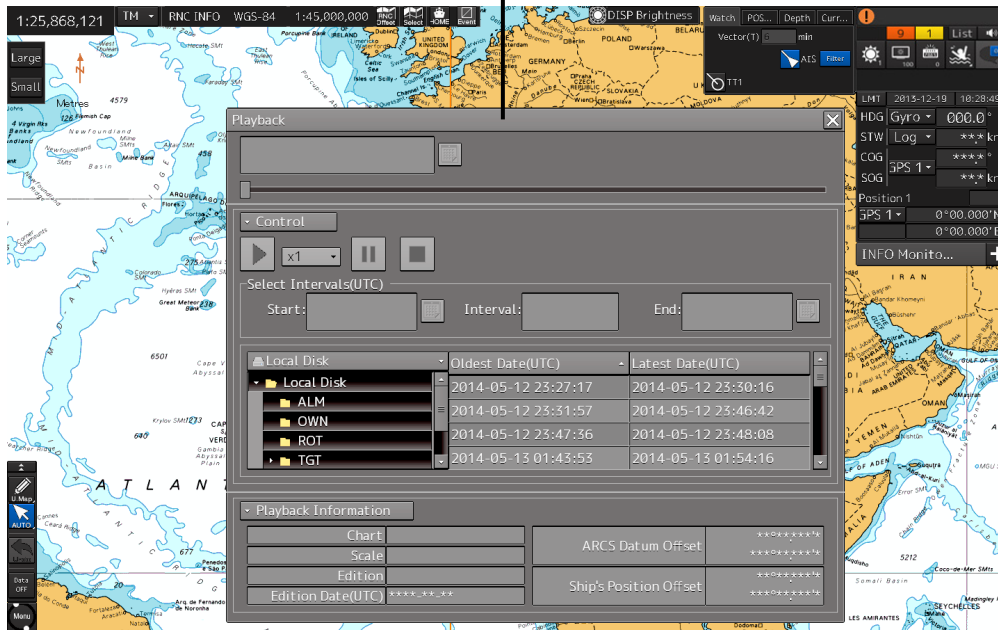

The following screen appears and the playback controller is displayed. (Playback mode)

Playback controller



The playback controller can move to any position on the screen; however, it cannot be minimized.

18.1 Playback Controller

The view of the playback controller can be switched between simplified display and full display by clicking the View Change button ( or ).

Simplified Display

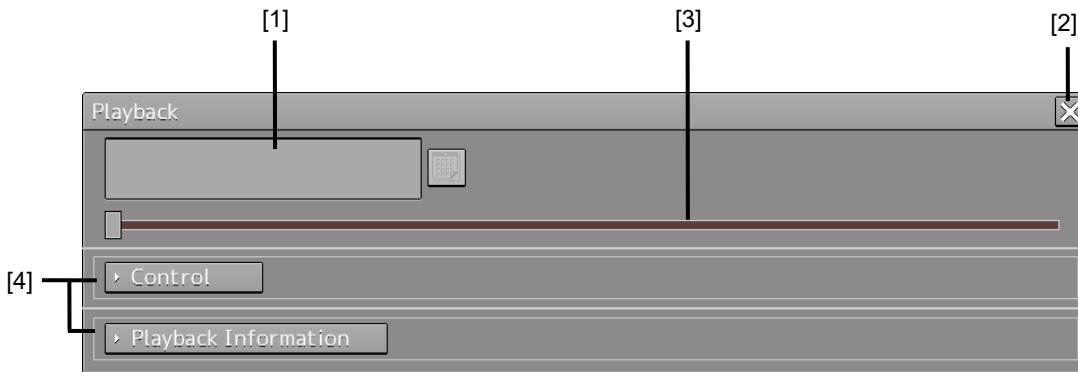

Full Display

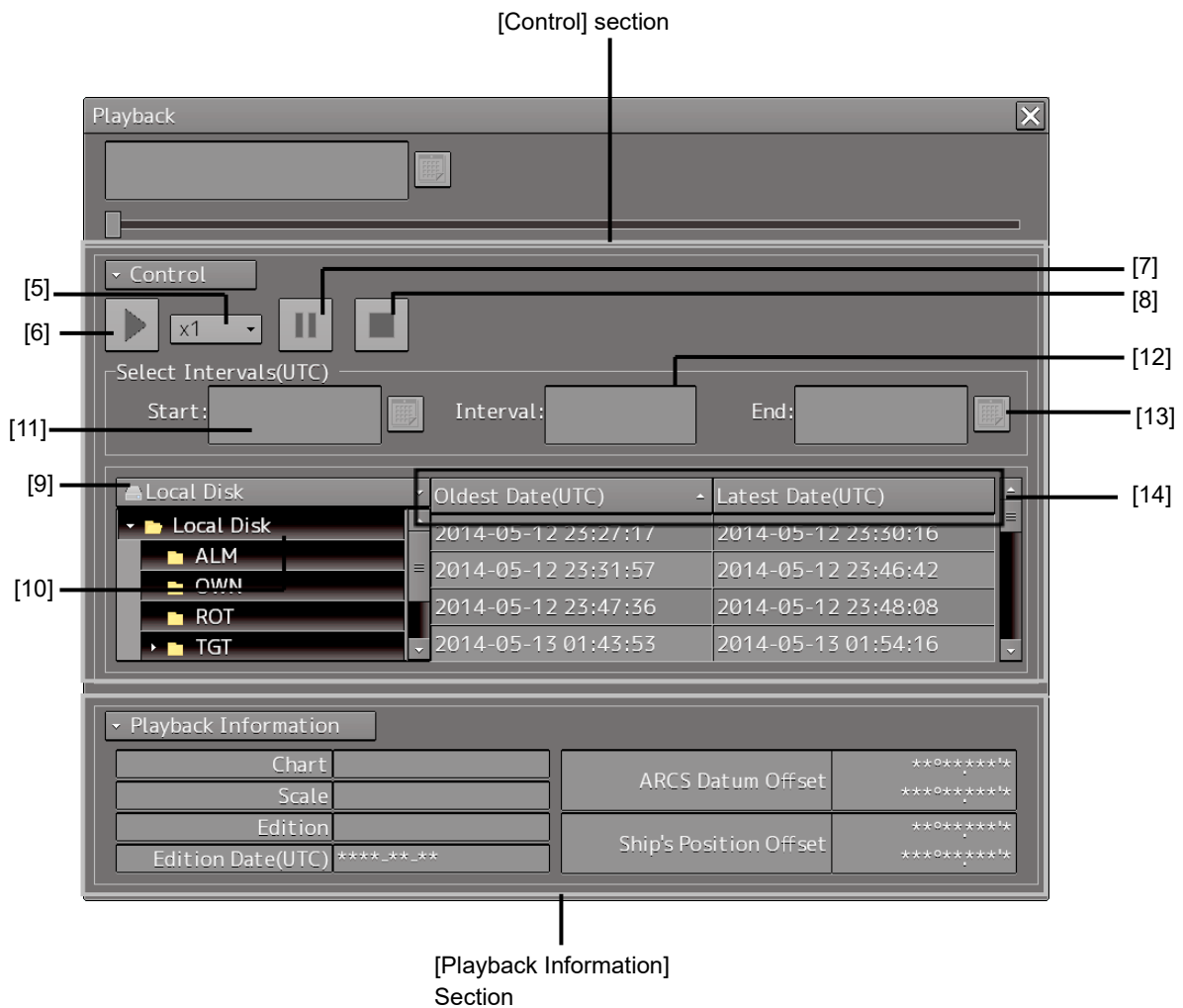

Upper Part of the Playback Controller

Number	Name	Function
1	Playback time	The playback time is displayed.
2	[X] (Close) button	Exits playback.
3	Playback slider	The progress of playback is displayed. The playback position can be changed by moving the slider control. <ul style="list-style-type: none"> • During playback, the pointer of the playback slider cannot be dragged. • During halt/temporary halt, the pointer of the playback slider can be dragged to any position.
4	View switch buttons	Switches between full display/simple display of the control section and the playback information section.

[Control] Section

Number	Name	Function
5	Playback speed selection box	Select the playback speed from the list. (x1, x2, x4, x10, x30, x60)
6	Playback button	Executes playback. When this button is clicked during playback, the playback speed changes in the following order: x1 ⇒ x2 ⇒ x4 ⇒ x10 ⇒ x30 ⇒ x60 ⇒ x1 ⇒
7	Pause button	Pauses playback. To resume, click the Playback button again.
8	Stop button	Stops playback. When playback is stopped, the playback time returns to the playback start time and the playback slider control returns to the playback start time position.
9	Drive selection box	Select a data drive storing navigation record data from the list.
10	Folder tree	Folders storing navigation record data are displayed in tree view.
11	Playback start time	The playback start time is displayed. By clicking the calendar icon, you can display the calendar picker and change the playback start time. Specify the playback time range concurrently with the playback end time. The range can be specified within the range from the start to the end of the recording of log data.
12	Playback segment	The playback segment is displayed. (When a playback list has not been selected, this box is blank.)
13	Playback end time	The playback end time is displayed. (When a playback list has not been selected, this box is blank.) By clicking the calendar icon, you can display the calendar picker and change the playback end time. Specify the playback time range concurrently with the playback start time. The range can be specified within the range from the start to the end of the recording of log data.
14	Playback list	Each record data is displayed in the order of the oldest time to the latest time. When [Oldest Date] or [Latest Date] on the title bar are clicked on, the data is sorted in the order of the oldest data or latest data.

[Playback Information] Section

Information of each record data is displayed.

Name	Function
Chart	The cell having the cell name of the chart being displayed when recorded is shown.
Scale	The scale of the chart being displayed when recorded is shown.
Edition	The version of the cell having the cell name of the chart being displayed when recorded is shown.
Edition Date (UTC)	The issue date of the chart being displayed when recorded is shown.
ARCS Datum Offset	The offset value of the ARCS chart when recorded is shown.
Ship's Position Offset	The offset value of own ship's position when recorded is shown.

18.2 Selecting Playback Data

Select the navigation record data you want to play back.

- 1 Click on the Drive Selection box to open the list, and then select a data drive storing navigation record data.



Folders saved on the selected data drive are displayed in tree view.

- 2 Select a folder storing the navigation record data you want to play back (ex. Playback folder).

Each navigation record data is displayed in the order of the oldest time to the latest time.

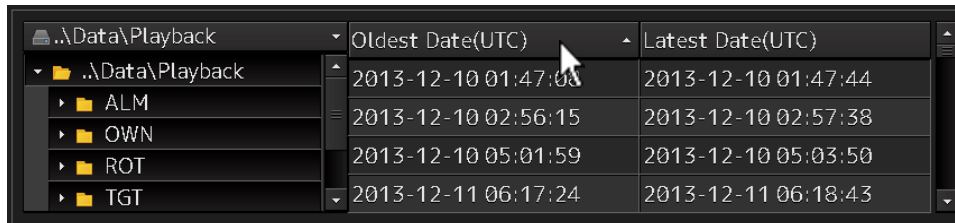

Folder	Oldest Date(UTC)	Latest Date(UTC)
..\Data\Playback	2013-12-10 01:47:08	2013-12-10 01:47:44
ALM	2013-12-10 02:56:15	2013-12-10 02:57:38
OWN	2013-12-10 05:01:59	2013-12-10 05:03:50
ROT	2013-12-11 06:17:24	2013-12-11 06:18:43
TGT		

- 3 Select the navigation record data you want to play back.

The oldest time and latest time of the selected navigation record data are reset to their initial values and then displayed in the playback list.

When navigation record data is selected, a chart is displayed in such a way that the position of own ship when recording has started is at the center of the dialog box. When display setting is executed, own ship's track is displayed on the chart.

18.2.1 Sorting the Playback List

Sort the logbook data display sequence in the ascending/descending sequence based on the oldest time/latest time.

- 1 Click the title bar on the control section.

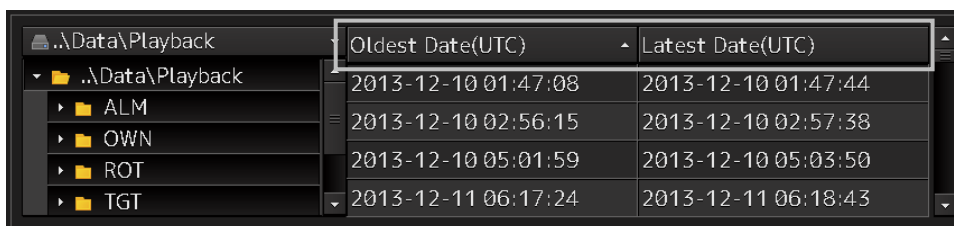

To sort navigation record data by the oldest time, click on [Oldest Date(UTC)]; to sort it by the latest time, click on [Latest Date(UTC)].

18.3 Playing Back Logbook Data

Play back the selected logbook data.

To Start Playback

1 Click on the Playback button.

Playback of navigation record data starts.

The Playback button is highlighted during playback, and the playback time indicator and the playback slider control are also linked with the playback.

To Pause Playback

1 Click on the Pause button.

Playback of navigation record data pauses.

The Pause button is highlighted while pausing, and the playback time indicator and the playback slider control also pause.

To resume, click on the Playback button.

To Stop Playback

1 Click on the Stop button.

Playback of navigation record data stops.

The Stop button is highlighted while stopping, and the playback time is reset to the playback start time and the playback slider control returns to the starting point at the left edge.

18.3.1 Changing the playback speed

Change the playback speed of logbook data.

- 1 Select a playback speed from the list in the playback speed selection box.

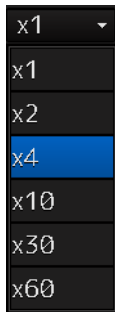

Navigation record data is played back at the selected playback speed.

The time shown on the playback time indicator and the progress shown on the playback slider control change according to the playback speed.

The playback speed can be changed by clicking on the Playback button repeatedly.

Each time the Playback button is clicked, the playback speed changes in the following order: x1 ⇒ x2 ⇒ x4 ⇒ x10 ⇒ x30 ⇒ x60 ⇒ x1 ⇒

18.4 Exiting the Playback Mode

Other tasks cannot be executed while the Playback dialog box is being displayed (during the Playback mode).

To execute other tasks, exit the Playback mode.

- 1 Click on the [X] (Close) button on the playback controller.

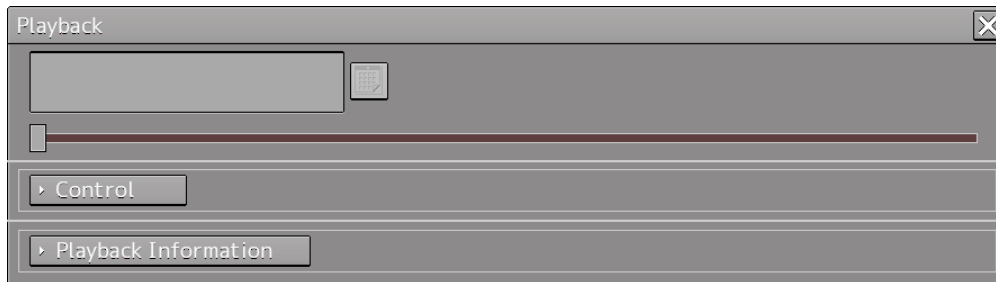

The Exit Confirmation dialog box appears.

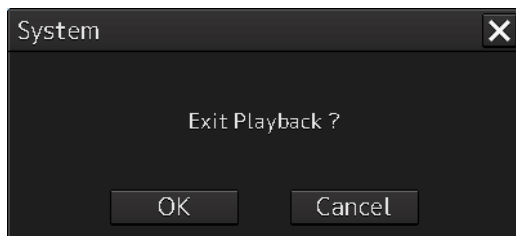

- 2 Click on the [OK] button.

The playback controller closes and the Playback mode ends.

To cancel exiting the Playback mode, click on the [Cancel] button.

18.5 Outputting Navigation Record Data

Select navigation record data from the File Manager submenu of the Tools menu, and then copy it to the output destination you specify.

1 Open the File Manager submenu of the Tools menu.

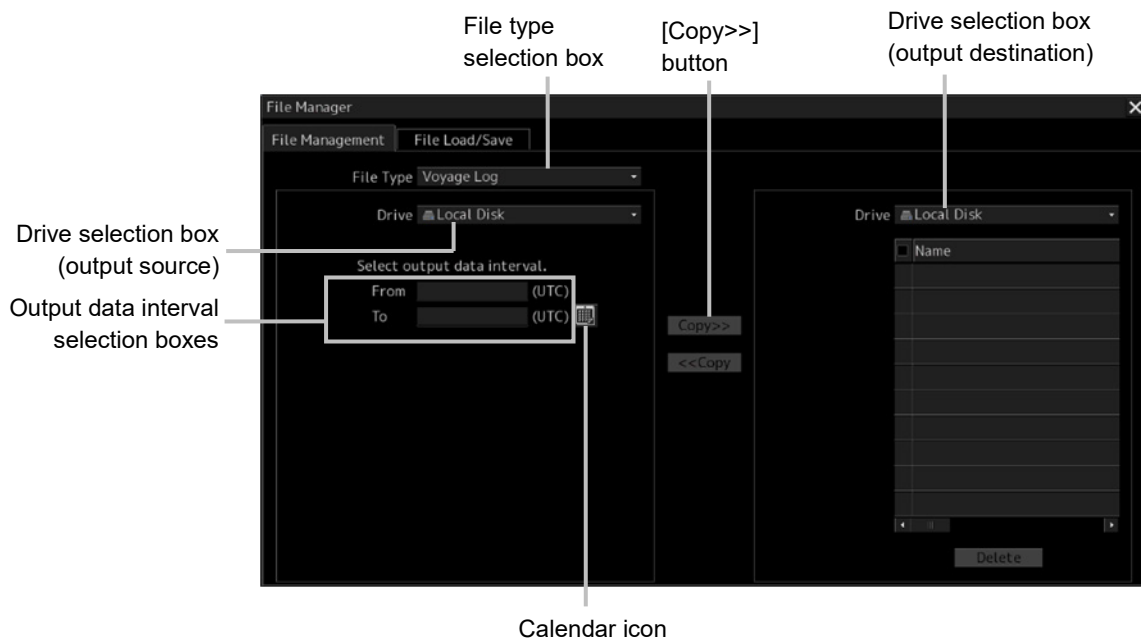

2 Select [Playback] from the File type selection box, and then select [Local Disk] from the Drive at the output source selection box.

Below the Drive at the output source selection box, the output data interval selection boxes and the calendar icon appear.

- 3** By clicking on the Calendar icon, specify the duration of the logbook data to be output. The selected dates appear in the output data interval selection boxes.

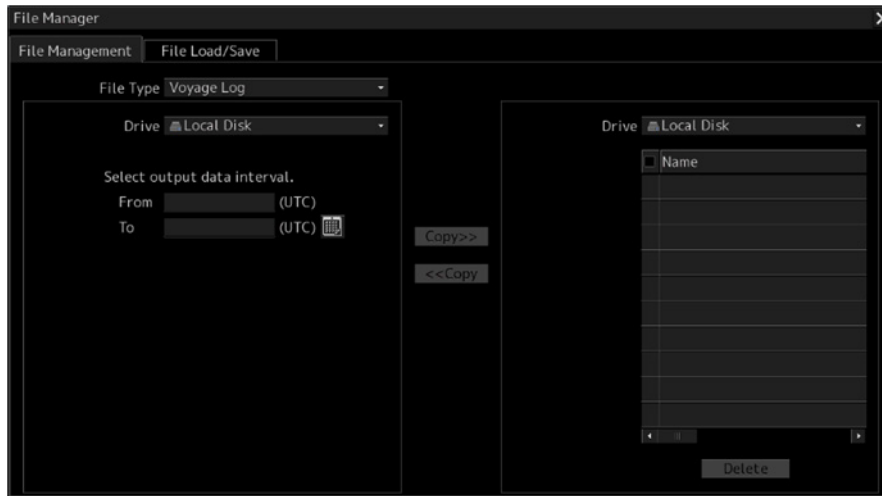

- 4** Specify the drive of the output destination from the output destination drive selection box and the output destination folder from the folder tree. The [Copy>>] button takes effect.

- 5** Click on the [Copy>>] button.

The following folder is created in the output destination path, and the navigation record data having the specified interval is copied to this folder.

Folder name: Playback_120108_120109

Output data start time [yymmdd] Output data end time [yymmdd]

18.6 Functional Restrictions When in the Playback Mode

Some functions are restricted in playback mode. The restricted functions are disabled.

Section 19 Maintenance & Inspection

19.1 Maintenance Functions Executed from Menu

This section explains maintenance functions that are executed from the menu.

19.1.1 Starting maintenance functions

- 1 Click on the [Menu] button on the left Tool Bar.**
The menu is displayed.
- 2 Click on the [Maintenance] button on the menu.**
The submenu is displayed.
- 3 Click on a button on the submenu.**
The dialog box of the selected maintenance function is displayed.

19.1.2 Setting Date/Time/Time Zone

- 1 Click on the [Menu] button on the left Tool Bar.**
The menu is displayed.
- 2 Click on the [Maintenance] - [Date/Time/Time Zone] button on the menu.**
The [Date/Time/Time Zone] dialog box appears.

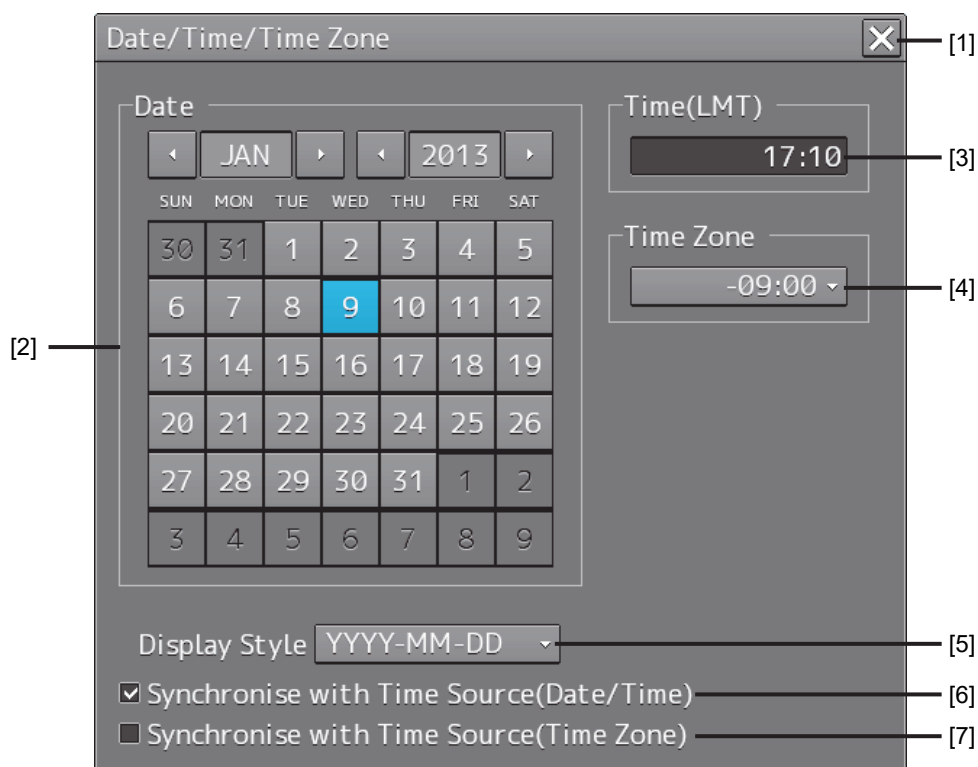

[1] [X] button

Click on this button to close the [Date/Time/Time Zone] dialog box.

[2] [Date]

Set the year, month and day on the calendar.

For the details of how to use the calendar, refer to "3.17 Setting a Date and a Time [Calendar Operation)".

[3] [Time(LMT)]

Enter the time in the input box. The time entered will be reflected on the clock.

[4] [Time Zone]

Enter the time zone in the time zone input box.

A time zone can be selected between -13:30 and +13:30 from UTC.

[5] [Display Style]

From the list, select the style to display the date.

- YYYY-MM-DD (Japanese style)
- MMM DD,YYYY (North American style)
- DD MMM,YYYY (European style)

[6] [Synchronise with Time Source (Date/Time)](synchronization of time with GPS)

When this item is checked, date and time are synchronized by using the time information (ZDA sentence) from GPS.

[7] [Synchronise with Time Source (Time Zone)](synchronization of time difference with GPS)

When this item is checked, time difference is synchronized by using the time information (ZDA sentence) from GPS.

Note

When [Synchronize with Time Source (Date/Time)] is not checked, the time is reset to the initial value at the start of power supply. Therefore, set a correct time manually.

19.1.3 Confirming System Information

System information can be confirmed.

1 Click on the [Menu] button on the left Tool Bar.

The menu is displayed.

2 Click on the [Maintenance] - [System Information] button on the menu.

The [System Information] dialog box appears.

The contents of the dialog will be switched by clicking on the selection tabs provided in the dialog box.

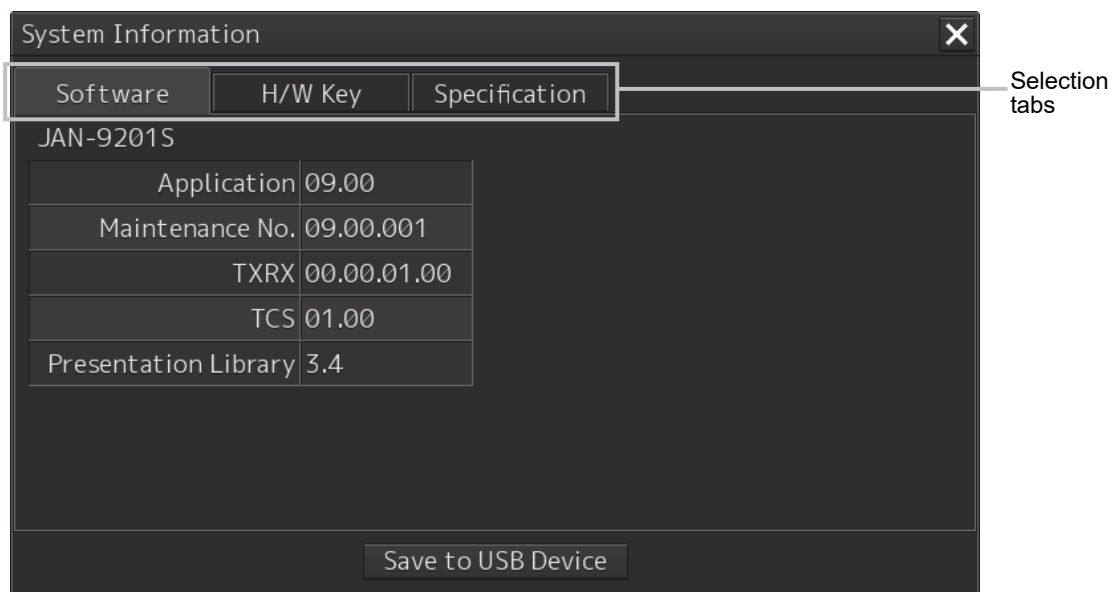

19.1.3.1 Confirming Software Information

 **WARNING**



When you want to use a USB flash memory to read or write a file, make sure in advance that the USB flash memory is not affected by a computer virus. If the indicator is infected with a virus, other equipment will also be infected, with the result that a trouble will occur.



Before removing the USB flash memory, check for the access lamp of the USB flash memory and make sure that it is not being accessed. If you remove the USB flash memory when it is accessed, data may be destroyed and a trouble may occur.

Software information can be confirmed.

- 1 Click on the [Menu] button on the left Tool Bar.**
The menu is displayed.
- 2 Click on the [Maintenance] - [System Information] button on the menu.**
The [System Information] dialog box appears.
- 3 Click on the [Software] tab.**
The software information is displayed.

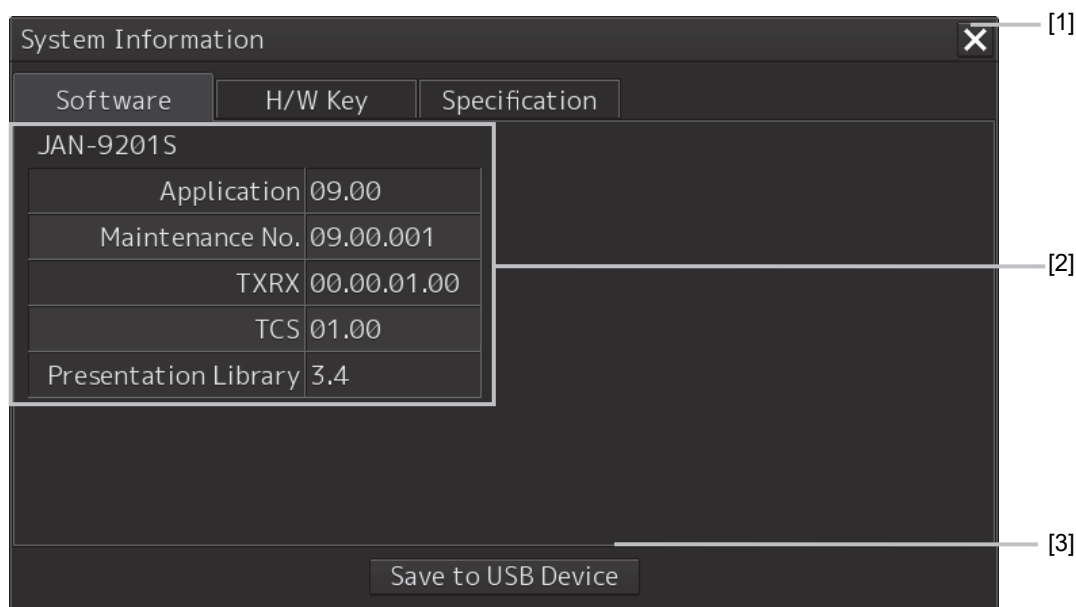

[1] [X] button

Click on this button to close the [System Information] dialog box.

[2] Software information

Item	Displayed information
Jxx-xxxx	Type and model name of the system
Application	Version of the application software
Maintenance No.	7-digit maintenance number
TXRX	Version of the software used for the radar transmitter-receiver unit * This information is displayed when the system is equipped with the RADAR function.
TCS	Version of the software used for TCS * This information is displayed when the system is equipped with the TCS function.
Presentation Library	Edition of S52 Presentation Library

[3] [Save to USB Device] (Saving to USB flash memory) button

Click on this button to save the displayed information in a USB flash memory in the text format.

19.1.3.2 Confirming H/W Key Information



WARNING



When you want to use a USB flash memory to read or write a file, make sure in advance that the USB flash memory is not affected by a computer virus. If the indicator is infected with a virus, other equipment will also be infected, with the result that a trouble will occur.



Before removing the USB flash memory, check for the access lamp of the USB flash memory and make sure that it is not being accessed. If you remove the USB flash memory when it is accessed, data may be destroyed and a trouble may occur.

Hardware key information can be confirmed.

- 1 Click on the [Menu] button on the left Tool Bar.**
The menu is displayed.
- 2 Click on the [Maintenance] - [System Information] button on the menu.**
The [System Information] dialog box appears.
- 3 Click on the [H/W Key] tab.**
The hardware key information is displayed.

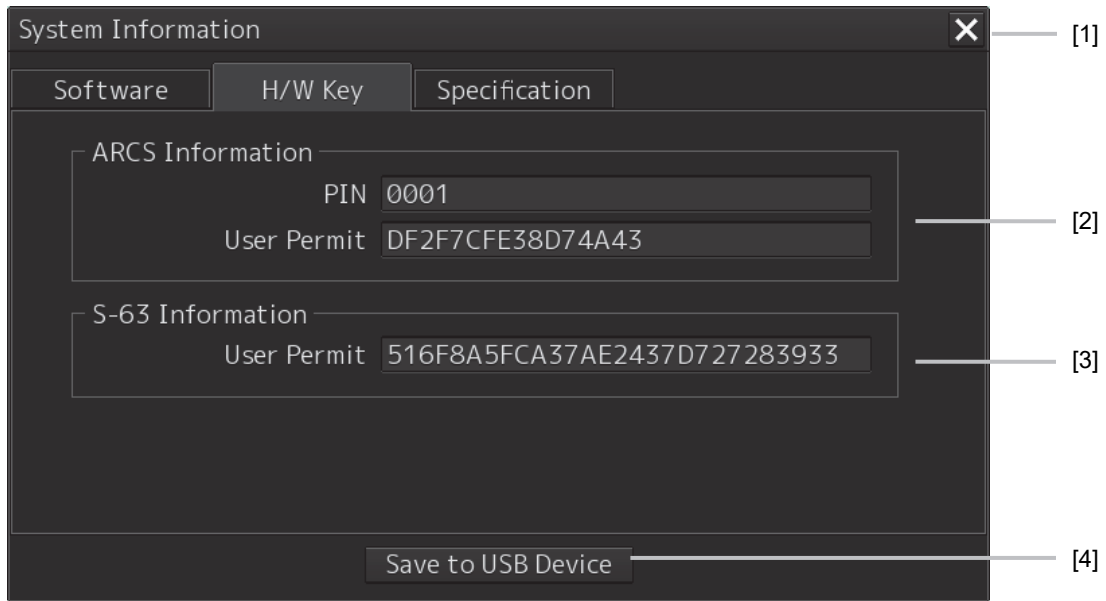

[1] [X]

Click on this button to close the [System Information] dialog box.

[2] [ARCS Information]

The ARCS PIN number and User Permit are displayed.



[3] [S-63 Information]

The S-63 User Permit is displayed.

[4] [Save to USB Device] (Saving to USB flash memory) button

Click on this button to save the displayed information in a USB flash memory in the text format.

19.1.3.3 Confirming the compliant standards for the equipment

 WARNING	
	When you want to use a USB flash memory to read or write a file, make sure in advance that the USB flash memory is not affected by a computer virus. If the indicator is infected with a virus, other equipment will also be infected, with the result that a trouble will occur.
	Before removing the USB flash memory, check for the access lamp of the USB flash memory and make sure that it is not being accessed. If you remove the USB flash memory when it is accessed, data may be destroyed and a trouble may occur.

The standards related to the equipment are displayed

- 1 Click on the [Menu] button on the left Tool Bar.**
The menu is displayed.
- 2 Click on the [Maintenance] - [System Information] button on the menu.**
The [System Information] dialog box appears.
- 3 Click on the [Specification] tab.**
The equipment License standard specification information is displayed.

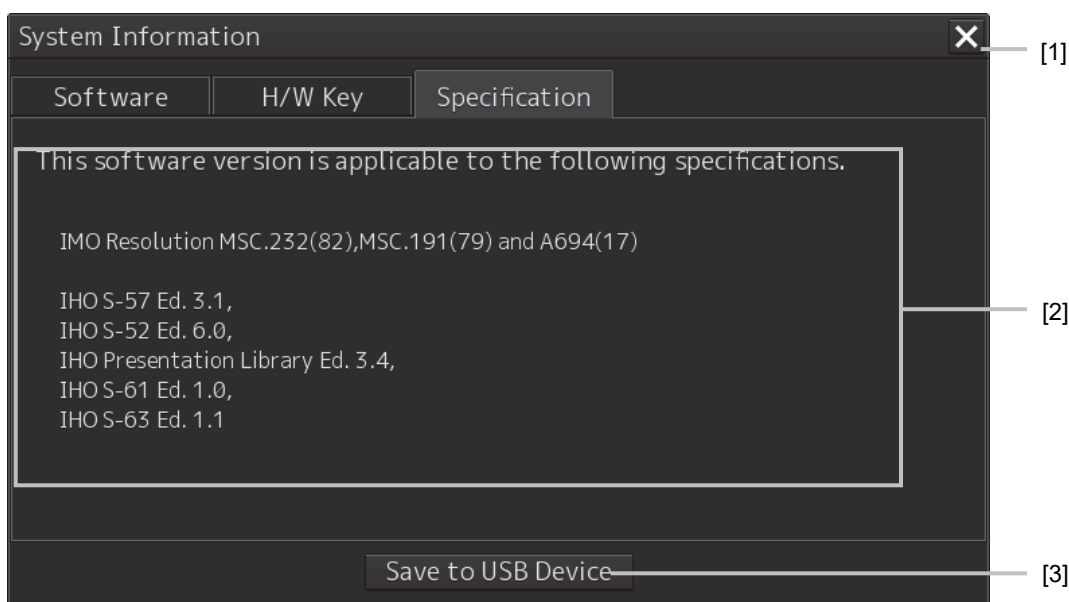

[1] [X] button

Closes the [System Information] dialog box.

[2] Equipment License information

The equipment License standard specification information is displayed.

[3] [Save to USB Device] (Saving to USB flash memory) button

Click on this button to save the displayed information in a USB flash memory in the text format.

19.1.4 Confirming Operating Time

Confirm the operating time of this system.

1 Click on the [Menu] button on the left Tool Bar.

The menu is displayed.

2 Click on the [Maintenance] - [Operating Time] button on the menu.

The [Operating Time] dialog box appears.

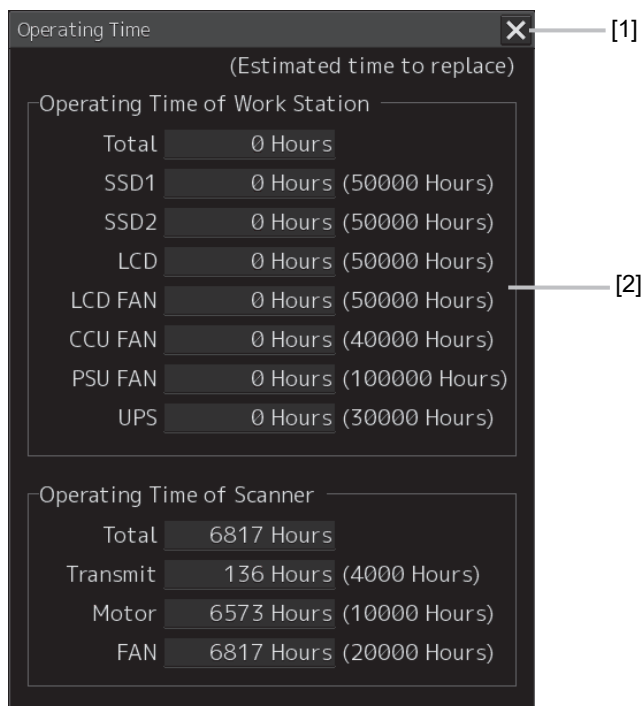

[1] [X] button

Click on this button to close the [Operating Time] dialog box.

[2] [Operating Time Of Work Station]

The operating time of this equipment is displayed.

[Total]: Total operating time of this equipment

[SSD1]: Total operating time of SSD1. The estimated replacement time is indicated in ().

[SSD2]: Total operating time of SSD2. The estimated replacement time is indicated in ().

[LCD]: Total operating time of LCD. The estimated replacement time is indicated in ().

[LCD FAN]: Total operating time of LCD FAN. The estimated replacement time is indicated in ().

[CCU FAN]: Total operating time of CCU FAN. The estimated replacement time is indicated in ().

[PSU FAN]: Total operating time of PSU FAN. The estimated replacement time is indicated in ().

[UPS]: Total operating time of UPS. The estimated replacement time is indicated in ().

Memo

[UPS] is displayed only when UPS is installed as an option.

19.1.5 Displaying and Resetting the Current Voyage Distance

This equipment displays the current voyage distance (estimated voyage distance) that is calculated from the speed over the ground and the speed through the water.

The voyage distance can also be reset.

Note

While the ship is anchored or sailing at low speed, it takes up to around 2 minutes to reset the current voyage distance.

1 Click on the [Menu] button on the Left Tool Bar.

A menu is displayed.

2 Click on [Maintenance] - [Voyage Distance] on the menu.

The [Voyage Distance] dialog is displayed.

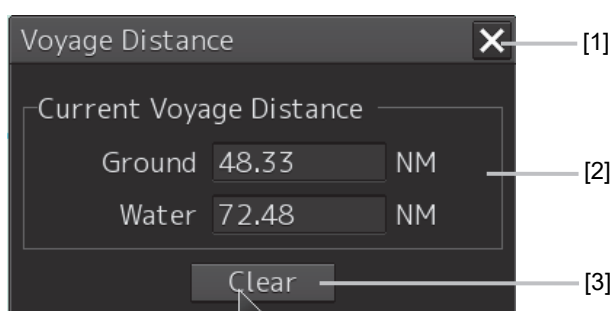

[1] [X] button

The [Voyage Distance] dialog is closed.

[2] [Current Voyage Distance]

The current voyage distance is displayed.

[Ground]: Indicates the current voyage distance that is calculated from the speed over the ground.

[Water]: Indicates the current sea distance that is calculated from the speed through the water.

[3] [Clear] button

The voyage distance is reset.

When this button is clicked on, a confirmation dialog is displayed.

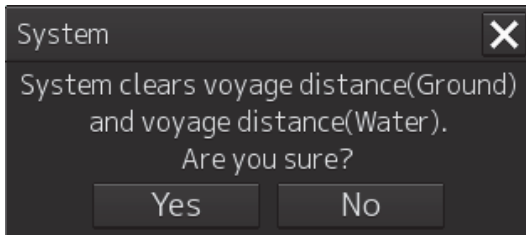

To reset the voyage distance, click on the [Yes] button. When not resetting the voyage distance, click on the [No] button.

Memo

When the voyage distance is reset in the [Voyage Distance] dialog, the voyage distance in the event detailed information in the logbook is also reset. The [Voyage distance (ground)] and [Voyage distance (water)] in the event detailed information are reset.

For the details of the event detailed information in the logbook, refer to “13.1.1 Event detailed information”.

19.1.6 Setting and confirming the Sensor Source

Set and confirm the sensor source.

- 1** Click on the [Menu] button on the left Tool Bar.
The menu is displayed.
- 2** Click on the [Maintenance] - [Sensor Selection/Status] button on the menu.
The [Sensor Selection/Status] dialog box appears.

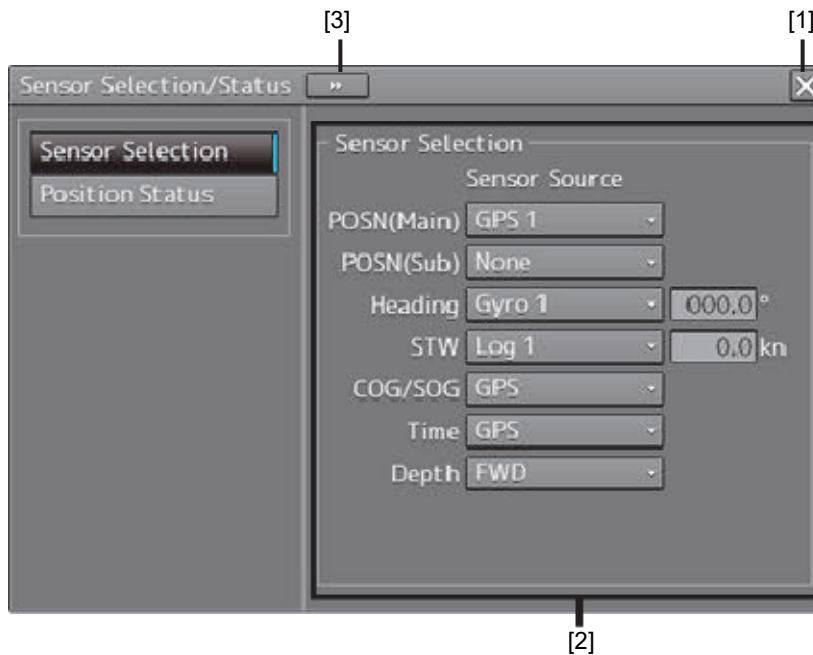

[1] [X] button

Closes [Sensor Selection/Status] dialog box.

[2] [Sensor Selection]

Enables selection of a sensor source.

Setting item	Setting contents	Setting value
POSN(Main)	Select a Primary Position sensor source from the combo box.	GPS x ("x" indicates the unit number)
POSN(Sub)	Select a Secondary Position sensor source from the combo box.	None, GPS x ("x" indicates the unit number)

Setting item	Setting contents	Setting value
Heading	<p>Select a heading sensor source from the combo box.</p> <p>* The sources that can be selected vary according to the installation.</p> <p>* When GyroSW is enabled, only Gryo and MAN can be selected.</p> <p>When the Gyro Compass system that is used has the automatic switching function, the sensor source display is switched automatically according to the switching condition.</p> <p>When the sensor source is set to [MAN], the ship's heading value can also be input in the input box.</p> <p>Ship's heading value input range: 0.0-359.9°</p>	<p>MAN, Gyro x, MAG, G/C</p> <p>("x" indicates the unit number)</p>
STW (Speed Through Water)	<p>Select a Speed Through Water sensor source from the combo box.</p> <p>* The source that can be selected varies depending on the installation</p> <p>* When 1AX is installed in Log, Log cannot be selected from the sensor source.</p> <p>When the sensor source is set to [Manual], a Speed Through Water can also be input in the input box.</p> <p>Speed Through Water value input range: -99.9-99.9kn</p>	<p>MAN, Logx</p> <p>("x" indicates the unit number)</p>
COG/SOG (Course Over the Ground/Speed Over the Ground)	<p>Select Course Over the Ground/Speed Over the Ground sensor source from the combo box.</p> <p>*The source that can be selected varies depending on the installation</p> <p>When GPS is selected for Position, the same GPS is selected automatically.</p>	<p>Log x, GPS</p> <p>("x" indicates the unit number)</p>
Time (Time correction)	<p>Select a sensor source to be used for time correction of this equipment from the combo box.</p> <p>*The source that can be selected varies depending on the installation</p>	<p>GPS, Ship Clock</p>
Depth (Water depth)	<p>Select a water depth sensor source from the combo box.</p> <p>*The source that can be selected varies depending on the installation</p>	<p>FWD, AFT, MID, AUTO*¹</p>

*1: When Echo Sounder 1 and Echo Sounder 2 are installed as depth sensor sources, E/S1 (AUTO) and E/S2 (AUTO) are displayed instead of AUTO.

[3] Disclosure button

When clicked, the left pane is hidden.

Memo

When Log Selector is installed and the Log (speed) sensor is switched automatically, a popup window is displayed, notifying the effect.

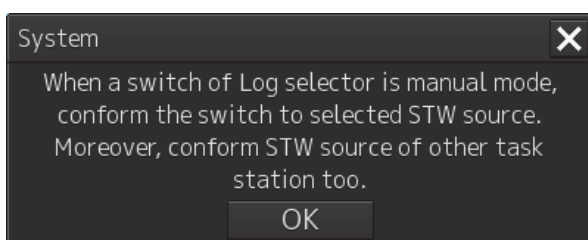

19.1.7 Checking the Route Plan Exchange Log





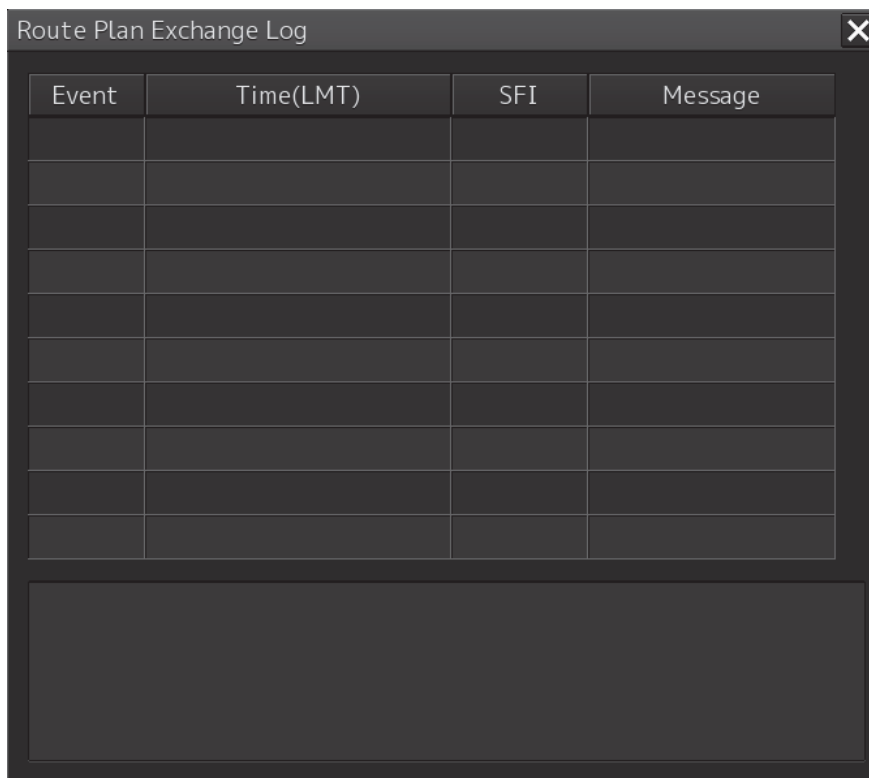

Checking the Route Plan Exchange Log.

- 1 Click on the [Menu] button on the left Tool Bar.**
The menu is displayed.
- 2 Click on the [Maintenance] - [Route Plan Exchange Log] button on the menu.**
The [Route Plan Exchange Log] dialog box appears.



Setting item	Setting contents	Setting value
Event	Specify reception or transmission.	Recv/Send/Timeout/Check
Time(UTC) or Time(LMT)	Displays the time of reception or transmission.	
SFI	When receiving: SFI of the transmission source device When transmitting: SFI of destination device	
Message	Displays the transmission / reception contents.	Query/Route Data/Route Plan/ Monitored Route/Alternate Route/ Response(Error)/Response(Accepted)/ Response(Reject)/Response(Pending)/ No Response(Query)/ No Response(Route)/No Data/ No Report/Correct/Incorrect
Detail View	Detailed display of error content etc.	

19.2 General Maintenance

 DANGER	
	Never attempt to check or repair the inside of the equipment. Checking or repair by an unqualified person may cause a fire or an electric shock. Contact our head office, or a nearby branch or local office to request servicing.
	Never remove the cover of this equipment. Touching the high-voltage section inside will cause an electric shock.
	Do not attempt to disassemble or tamper with this equipment. Otherwise, a fire, an electric shock, or a malfunction may occur.
	When conducting maintenance, make sure to turn the main power off. Failure may result in electric shock.
	Turn off all the main powers before cleaning the equipment. Especially when an UPS is used, make sure to turn it off since voltage is still outputted from the UPS even after the indicator and the ECDIS are turned off. Failure may result in equipment failure, or death or serious injury due to electric shock.

For operating this equipment in the good conditions, it is necessary to make the maintenance work as described below. If maintenance is made properly, troubles will reduce. It is recommended to make regular maintenance work.

The general maintenance work common among each equipment is as follows.

Clean the equipment.

Remove the dust, dirt, and sea water rest on the equipment cabinet with a piece of dry cloth. Especially, clean the air vents with a brush for good ventilation.

19.3 Maintenance on Unit

19.3.1 Display unit

WARNING



When cleaning the screen and Trackball of Operation Unit, do not wipe hard with a dry cloth. Also, do not use glass cleaner, alcohol, gasoline, or thinner to clean the screen. Also avoid wiping with water. It may cause surface damage or equipment failure.



When conducting maintenance work, make sure to turn off the power so that the power supply to the equipment is completely cut off. Some equipment components can carry electrical current even after the power switch is turned off, and conducting maintenance work may result in electric shock, equipment failure, or accidents.

19.3.1.1 The Screen

Dust accumulated on the screen will reduce clarity and darken the video.

Use a soft cloth such as flannel and cotton to clean the screen to prevent damage or degradation of the screen coating.

19.3.1.2 The Trackball

Clean carefully the trackball operation unit in accordance with this procedure in order not to scratch the lens. The tools shown in the following table are required in this work.

	Required tools
1	Dry/Moist soft cloth (Lint-free)
2	Swab

Note

If you do not have the swab, please use lint-free cloth, moistened with water, instead.

- 1 Turn stopper ring in the direction of the triangle marks (counterclockwise), then remove the stopper ring together with the ball.



- 2 Clean the ball with a moist lint-free cloth, then wipe the ball with a dry soft cloth carefully.
- 3 Clean the inside of the stopper ring and the trackball housing, and the lens with a swab, moistened with water. Change the swab regularly so that dirt and dust build-up is easily removed. Wipe away moisture with a dry swab.



- 4 After cleaning them, reinstall the ball and the stopper ring. Don't forget to tighten the stopper ring.

19.4 Performance Check

Make performance check on the radar equipment regularly and if any problem is found, investigate it immediately. Pay special attention to the high voltage sections in inspection and take full care that no trouble is caused by any error or carelessness in measurement. Take note of the results of inspection, which can be used effectively in the next inspection work.

Carry out performance check on the items listed in the check list below.

Check List

Equipment	Item to be checked	Criteria
Display unit	Screen image Screen operation	Can be correctly controlled
	Cleaning the DVD drive	19.4.7 Cleaning the lens of the DVD drive

19.4.1 Starting Selftest functions

- 1 Click on the [Menu] button on the left Tool Bar.**
The menu is displayed.
- 2 Click on the [Maintenance] - [Selftest] button on the menu.**
The [Selftest] dialog box appears.

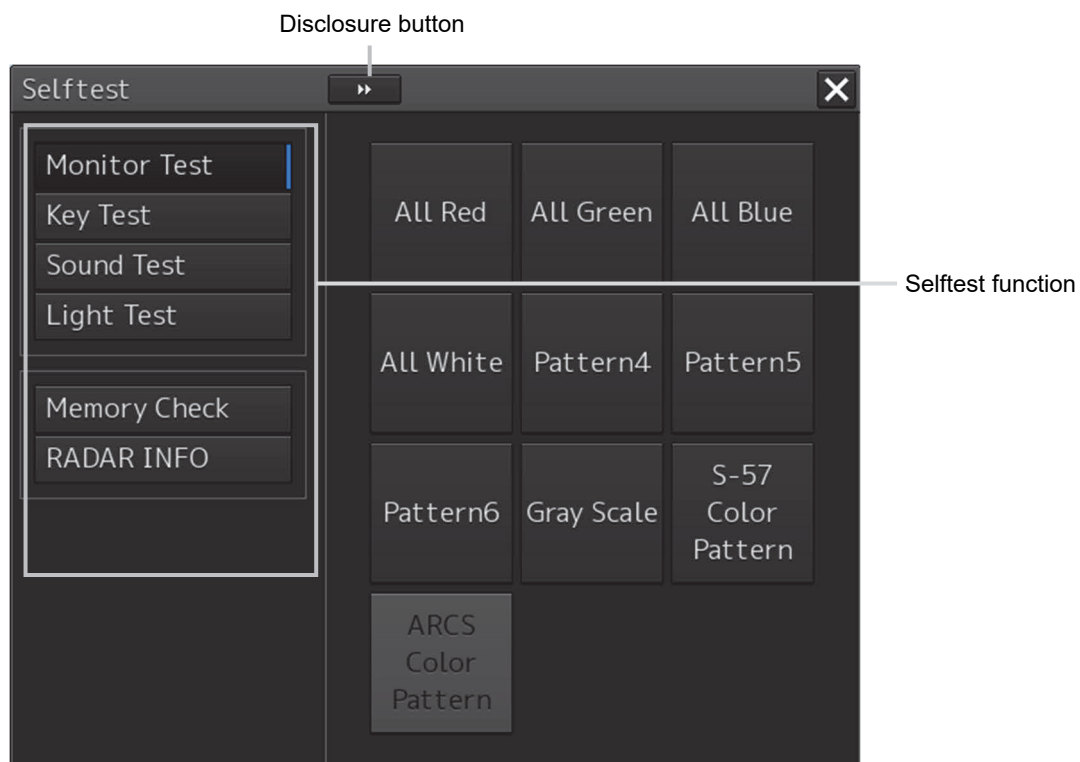

The Selftest functions are displayed in the left pane.

Click on the disclosure button to hide the left pane.

- 3 Click on a Selftest function to be executed.**
The execution dialog of the selected Selftest function is displayed.

19.4.2 Confirming the screen status [Monitor Test]

Confirm the screen status.

- 1 Click on the [Menu] button on the left Tool Bar.

The menu is displayed.

- 2 Click on the [Maintenance] - [Selftest] - [Monitor Test] button on the menu.



When the color or pattern of the dialog is clicked on, the color or pattern is displayed on the screen.

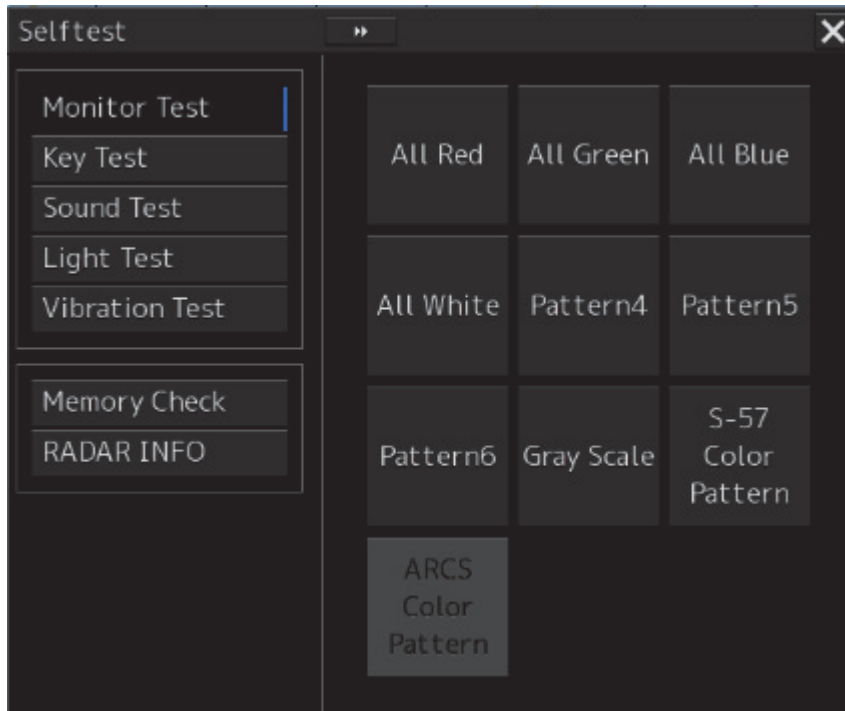

Check the screen status with the display status.



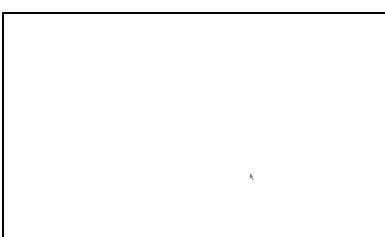
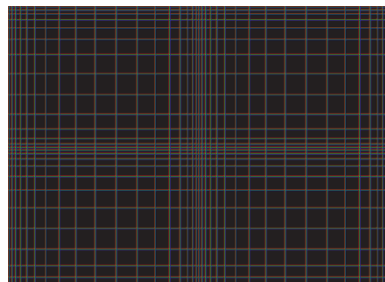

To reset the display, click the button again.

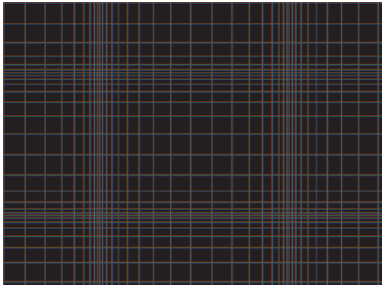
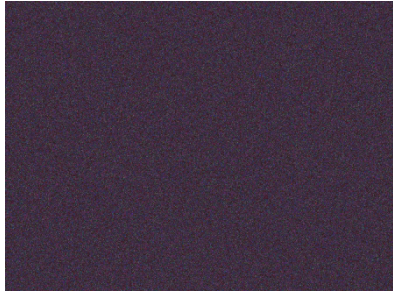
Pattern list

Pattern button name	Display
All Red	 <p>The entire screen is displayed in red.</p>
All Green	 <p>The entire screen is displayed in green.</p>
All Blue	 <p>The entire screen is displayed in blue.</p>
All White	 <p>The entire screen is displayed in white.</p>
Pattern4	 <p>Displays the pattern for checking the communication quality for VDR.</p>

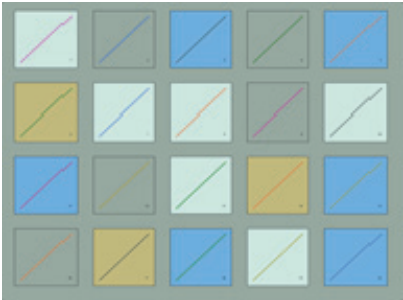
Pattern button name	Display
Pattern5	 <p data-bbox="472 555 1286 584">Displays the pattern for checking the communication quality for VDR.</p>
Pattern6	 <p data-bbox="472 943 1286 972">Displays the pattern for checking the communication quality for VDR.</p>
Gray Scale	 <p data-bbox="472 1326 1390 1397">Displays the grey scale pattern for checking the monitor brightness adjustment.</p> <p data-bbox="472 1413 1390 1570">Grey scale patterns can be identified with brightness in day/night mode. By adjusting the monitor brightness to facilitate identification of grey scale patterns, the optimum brightness can be set. The brightness in night mode can also be adjusted in the same way.</p> <p data-bbox="472 1585 1390 1655">Use the Day/Night button on the right Tool Bar for switching between the day and night mode.</p> <p data-bbox="472 1671 1278 1700">For the details of the Day/Night button, refer to "2.2.2 Right toolbar".</p>

Pattern button name	Display
S-57 Color Pattern	 <p>A color test pattern of the S57 chart is displayed. By identifying the color pattern, the S57 chart display status can be verified. A color pattern can be displayed in Day/Night mode. Use the Day/Night button on the right Tool Bar for switching between the day and night mode. For the details of the Day/Night button, refer to "2.2.2 Right toolbar"</p>
ARCS Color Pattern	 <p>The [ARCS Color Pattern] dialog is displayed.</p> <p>A color test pattern of the ARCS chart is displayed. By identifying the color pattern, the ARCS chart display status can be verified. A color pattern can be displayed in Day/Night mode. Use the Day/Night button on the right Tool Bar for switching between the day and night mode. For the details of the Day/Night button, refer to "2.2.2 Right toolbar "</p>

19.4.3 Confirming the operation of the operation unit [Key Test]

Confirm the operation of the keys of the operation unit.

- 1 Click on the [Menu] button on the left Tool Bar.
The menu is displayed.
- 2 Click on the [Maintenance] - [Selftest] - [Key Test] button on the menu.
- 3 Click on the [Key Test Start] button.

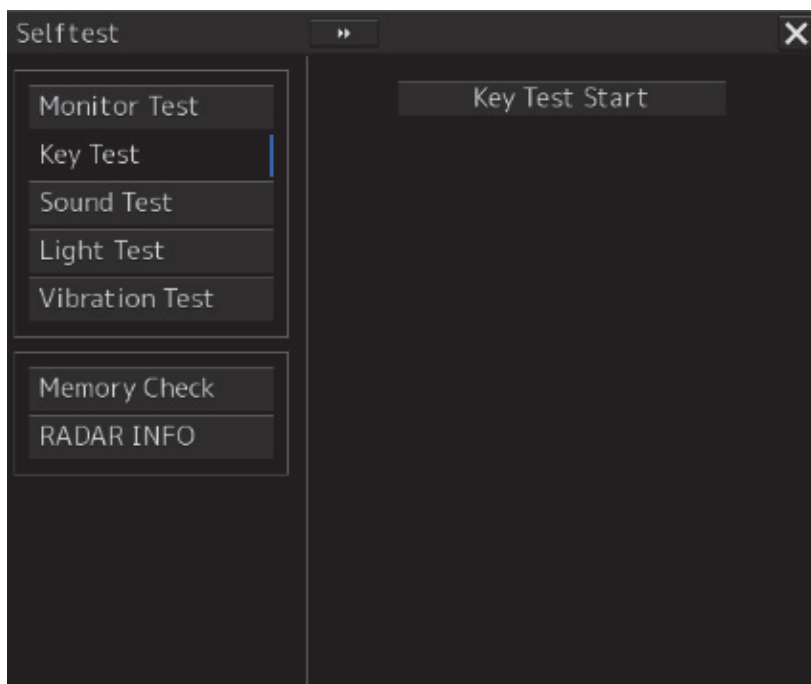

Key Test window is displayed.

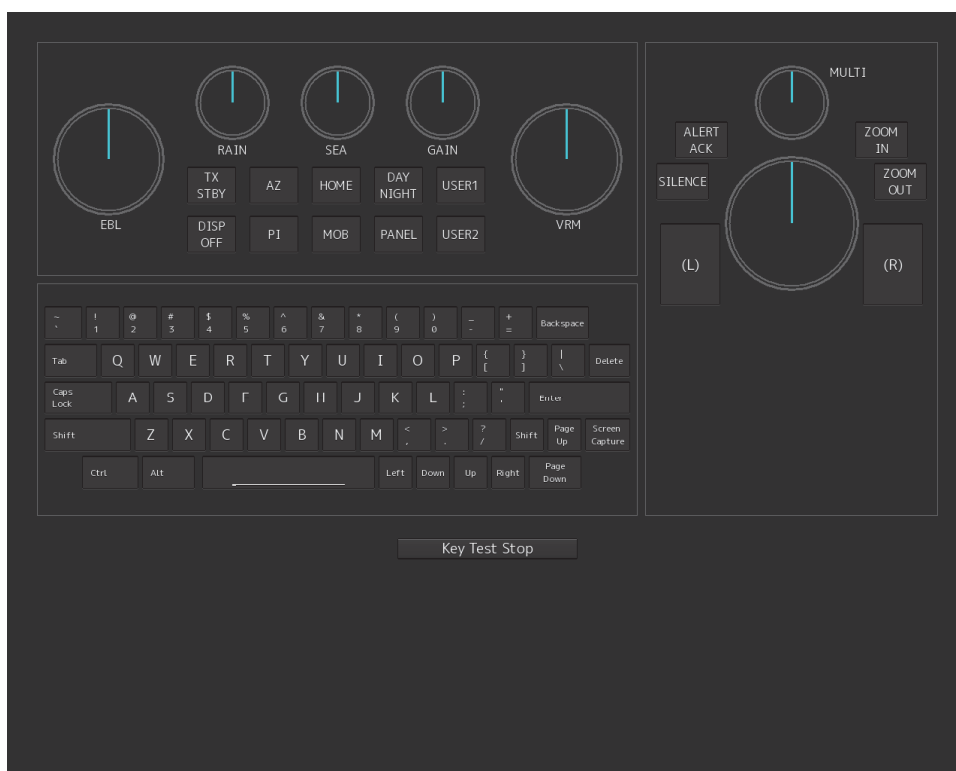

4 Operate the keys, buttons and dials in the operation unit.

If the performance of the operation unit is normal, the colors of the keys, buttons and dials are changed.

5 Click on the [Key Test Stop] button after the operation check.

Returns to the [Selftest] dialog box.

19.4.4 Confirming the alert sound [Sound Test]

Confirm the alert sound.

1 Click on the [Menu] button on the left Tool Bar.

The menu is displayed.

2 Click on the [Maintenance] - [Selftest] - [Sound Test] button on the menu.

3 Click on the [Sound Test Start] button.

A sound test starts. All the available beep sound volumes can be tested by increasing the level from 0.

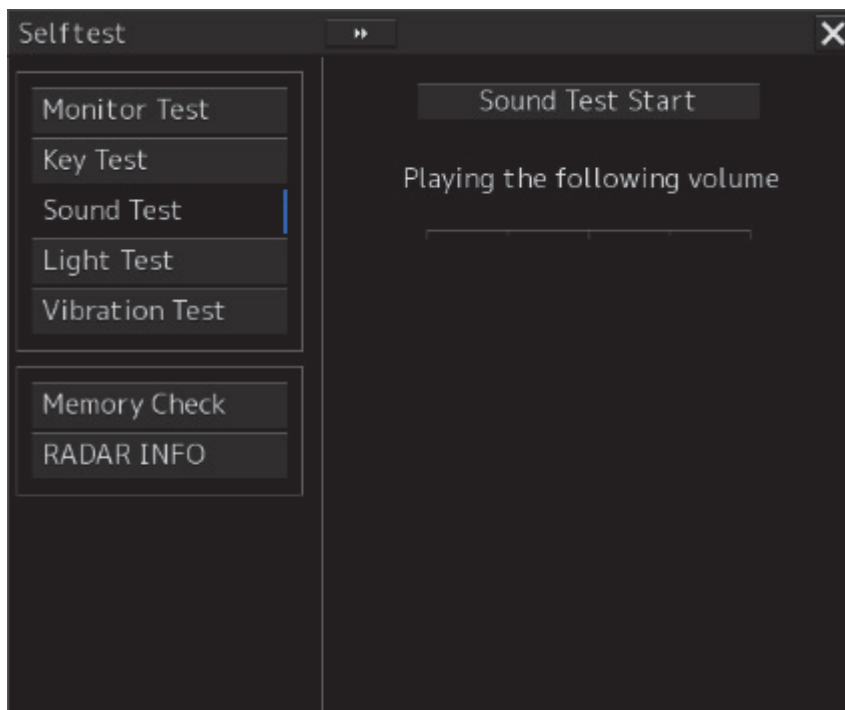

19.4.5 Testing the brightness of LED [Light Test]

Test the brightness of the LED of the operation unit.

- 1 Click on the [Menu] button on the left Tool Bar.**

The menu is displayed.

- 2 Click on the [Maintenance] - [Selftest] - [Light Test] button on the menu.**

- 3 Click on the [Light Test Start] button.**

A LED brightness test starts. All the available brightness levels can be tested by increasing the level from 0.

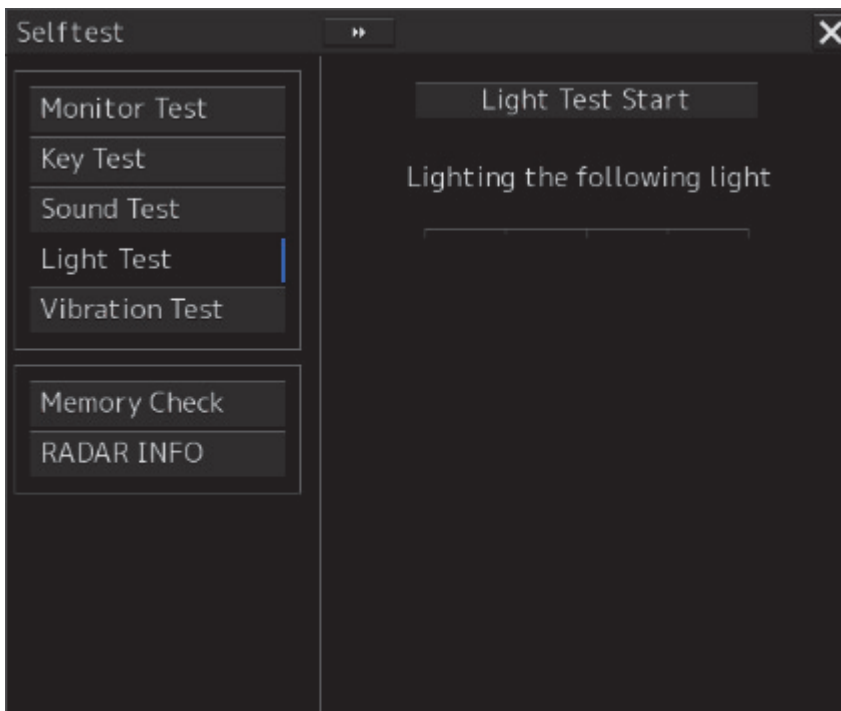

19.4.6 Checking the memory [Memory Check]

Check the memory.

- 1 Click on the [Menu] button on the left Tool Bar.**
The menu is displayed.
- 2 Click on the [Maintenance] - [Selftest] - [Memory Check] button on the menu.**
- 3 Click on the [Memory Check Start] button.**
Memory checking starts and the checking result is displayed on the [Result] list.

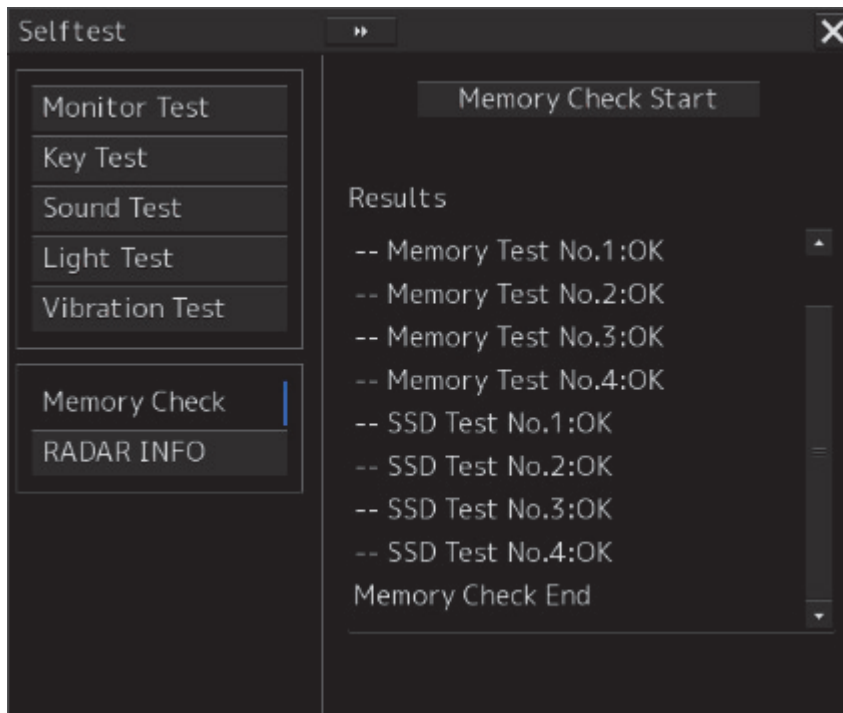

19.4.7 Cleaning the lens of the DVD drive

- 1 Insert the supplied lens cleaner CD into the DVD drive.
- 2 Click on the [Menu] button on the left Tool Bar.
The menu is displayed.
- 3 Click [Maintenance] - [Selftest] - [DVD Drive Cleaning] from the menu.
Cleaning automatically starts.
The following dialog box appears during cleaning:

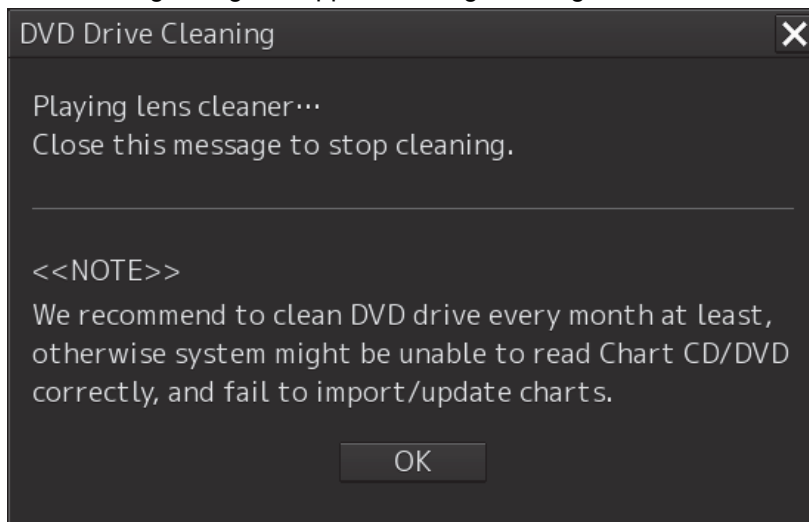

- 4 When the cleaning completion dialog box appears, click on the [OK] button.



Remove the supplied lens cleaner CD.

Note

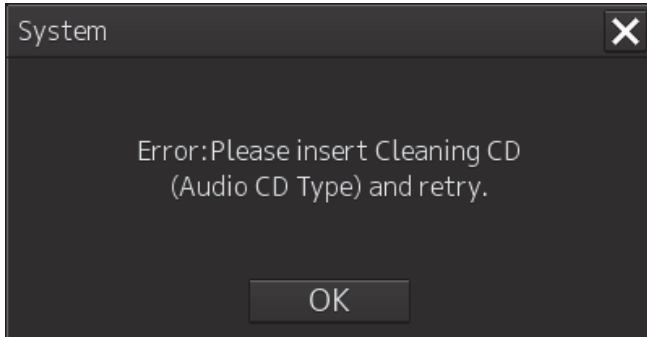

It is recommended that the DVD drive is cleaned at least once a month. If the lens becomes dirty, it may not be possible to read data from a CD/DVD, or else it may not be possible to install a chart or an update.

When reading the lens cleaner CD fails, an error dialog box appears.



19.5 Replacement of Major Parts

The system includes parts that need periodic replacement. The parts should be replaced as scheduled. Use of parts over their service life can cause a system failure.

 CAUTION	
	Turn off the main power source before inspecting and replacing parts. Otherwise, an electric shock or trouble may be caused.
	The liquid crystal monitor shall be replaced by two more persons. If only one person does this work, he may drop the LCD, resulting in injury.

19.5.1 Parts expected for periodic replacement

Here are parts expected for periodic replacement.

Part type	Name	Part name	Life expectancy	Replacement kit type
NWZ-207	19inch monitor	FAN	40,000 hours	7ZYNA4004
NWZ-214	19inch monitor	FAN	60,000 hours	7BFRD0008
NWZ-208	26inch monitor	FAN	40,000 hours	7ZYNA4005
NBD-913	Power supply unit	FAN	100,000 hours	7ZYNA4007
QUINT-BAT/ 24DC/3.4AH	DC UPS (Option)	Battery	30,000 hours	QUINT-BAT/ 24DC/3.4AH
NDC-1590E/ AE	Central control unit	FAN	40,000 hours	7ZYNA4006

Memo

[UPS] is required only when it is installed as an option.

19.6 Software Update

This section describes software update of this equipment.

Note

When software update starts, the tasks that are active are automatically terminated. Complete the necessary operation such as saving of settings prior to the start of update.

- 1 Set the CD/DVD or USB flash memory containing the update data.**
- 2 Click on the [Menu] button on the left Tool Bar.**
The menu is displayed.
- 3 Change over to the second page using the page switching button, and click [Maintenance] - [Software Update].**

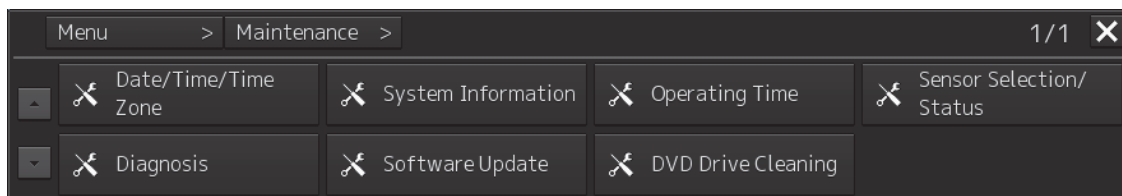

The [Software Update] dialog box appears.

- 4 Click on the [Software Update] button.**

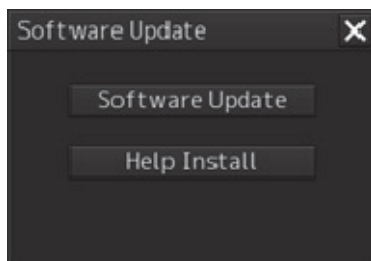

A file selection dialog box appears.

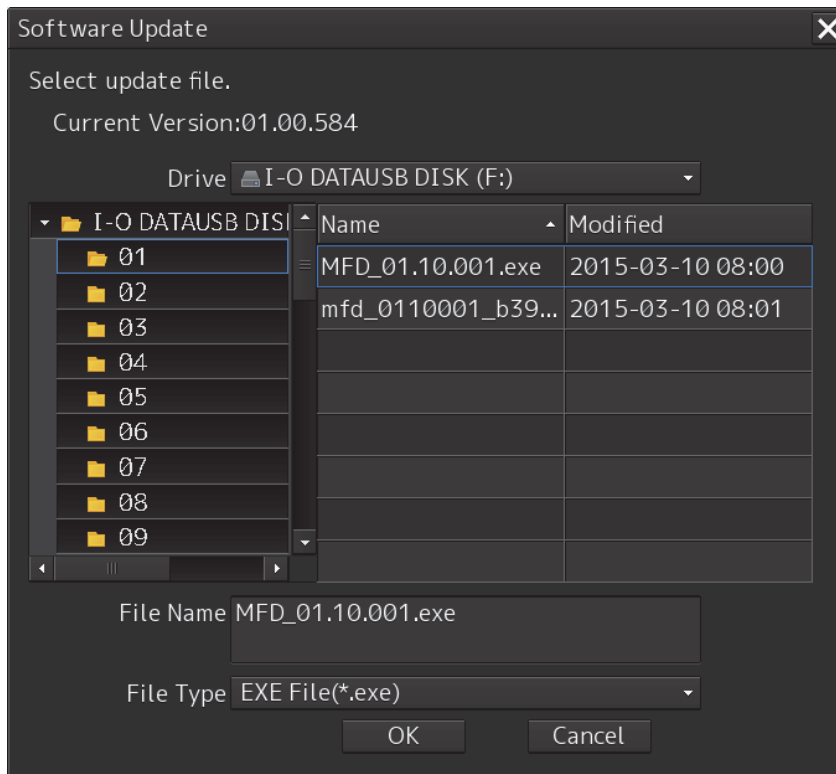

- 5** From the "Drive" combo box, select the drive where the updating data is stored.
- 6** From the file list, select the file MFD_xx.xx.xxx.exe.
MFD_xx.xx.xxx.exe is displayed in [File name].
- 7** Click the [OK] button.
The update content confirmation dialog box appears.

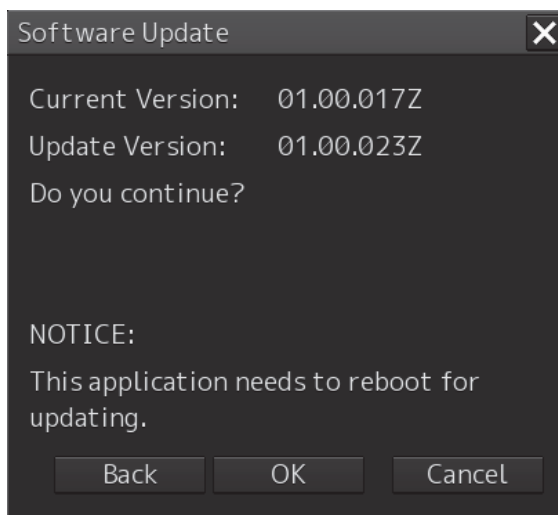

8 Confirm the contents and click "OK".

The following screen may be displayed.

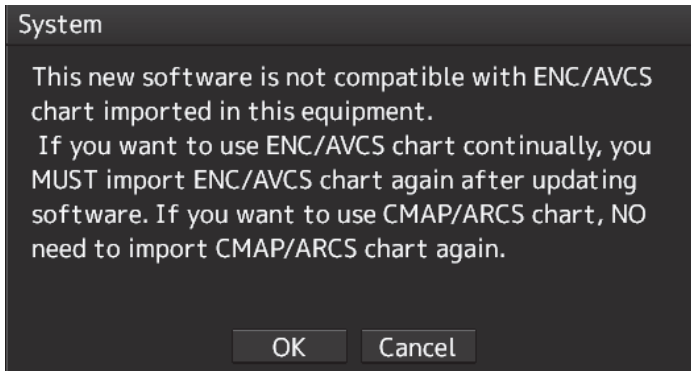

Note

When this popup message is displayed, the chart data is deleted after completion of software update. Re-import the chart after completion of software update.

9 Confirm the contents and click "OK".

Installation of the update is started and the following screen is displayed.

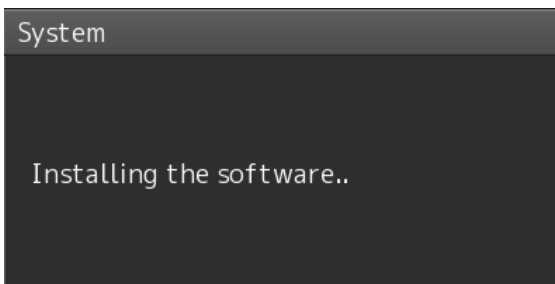

Wait for some time until the installation is completed.

Note

This equipment may restart during installation.

At completion of installation, the following screen is displayed.

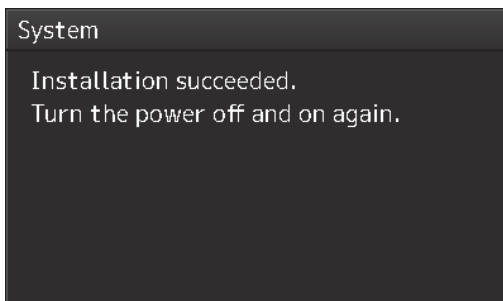

10 Switch OFF the power supply of this equipment.

11 Restart this equipment.

12 Start ECDIS, and confirm that the software version number has been updated in the "Software" tab by selecting [Maintenance] - [System Information].

19.7 Firmware Update

Explain firmware update of this product.

Note

When the firmware update is started, the active task is automatically terminated.
Please complete necessary operations, such as saving settings, before updating starts.

- 1 Click on the [Menu] button on the left Tool Bar.**
The menu is displayed.
- 2 Change over to the second page using the page switching button, and click [Maintenance] - [Software Update].**

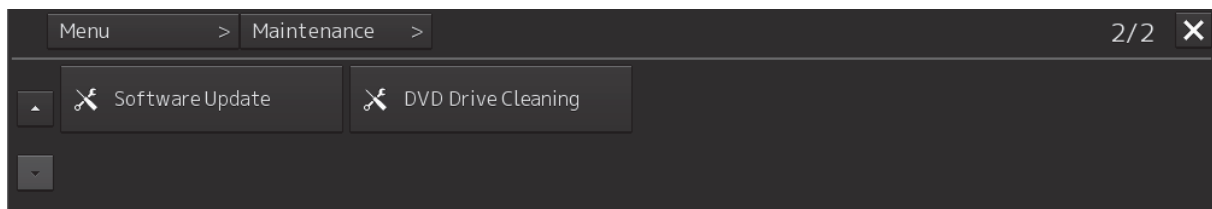

The [Software Update] dialog box appears.

- 3 Click on the [Software Update] button.**

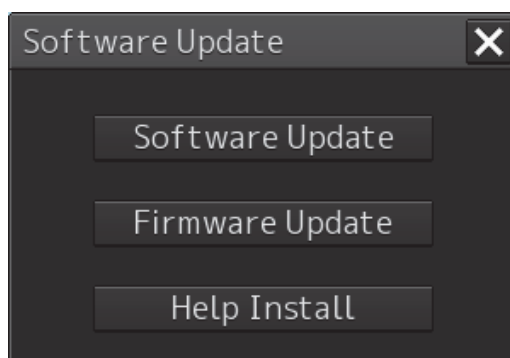

A file selection dialog box appears.

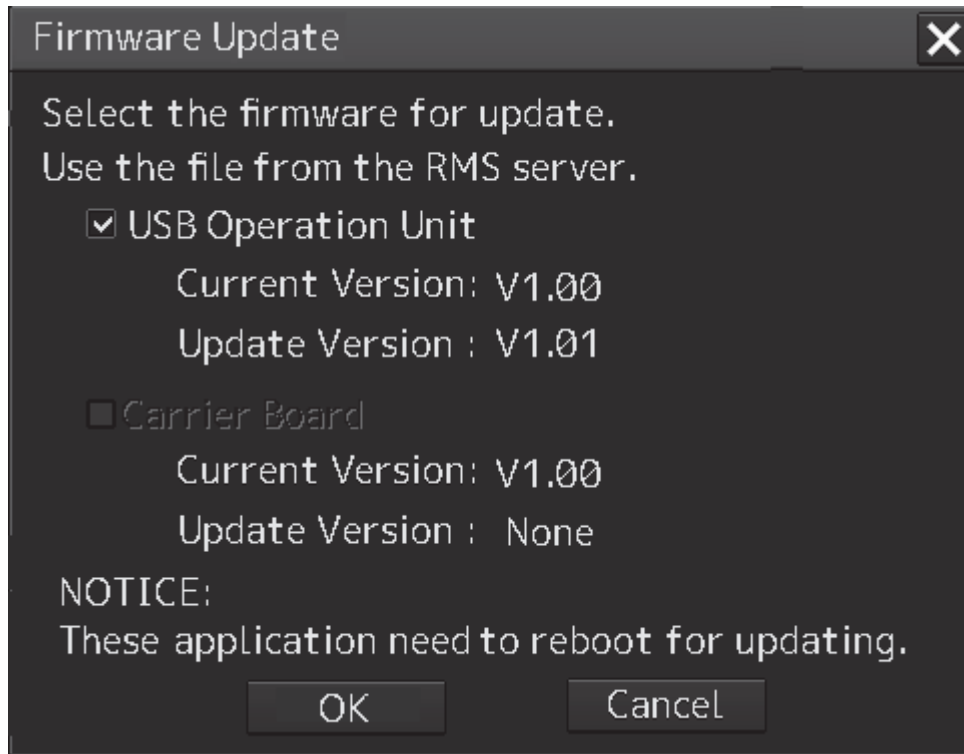

USB Operation Unit

Select this when updating the firmware of the USB operation unit.

Carrier Board

Select this when updating the companion's firmware.

4 Click the [OK] button.

Firmware update is started and a popup is displayed.

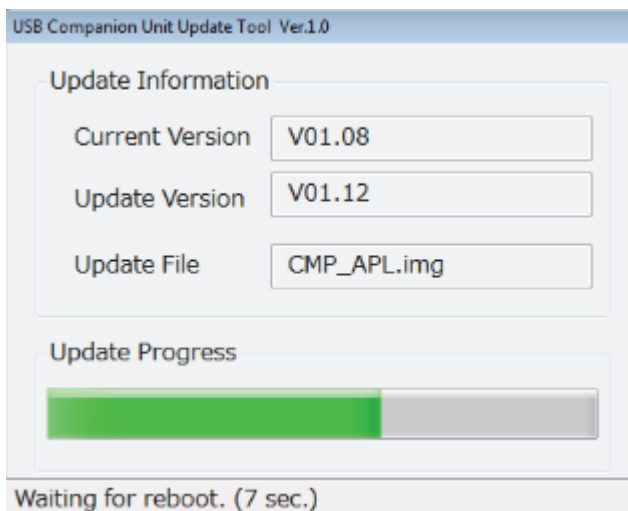

When the update is completed, the following screen will be displayed.

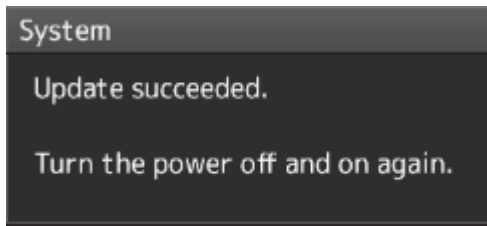

- 5** Switch OFF the power supply of this equipment.
- 6** Restart this equipment.

19.8 Updating Help Data

This section describes updating of help data of this product.

Note

- Help data is classified to the data for RADAR, data for ECDIS, and data for Conning Display. To display help information on each of the RADAR screen, ECDIS screen, and Conning Display screen, install the help data for each display.
- When Help update starts, currently active tasks are terminated automatically. Complete the necessary operations, such as saving the settings, before the start of update.

- 1 Set the CD/DVD or USB memory where update data is stored.**
- 2 Click the [Menu] button on the Left Tool Bar.**
A menu is displayed.
- 3 Switch the page to the 2nd page by using the page switching button and click [Maintenance] - [Software Update].**

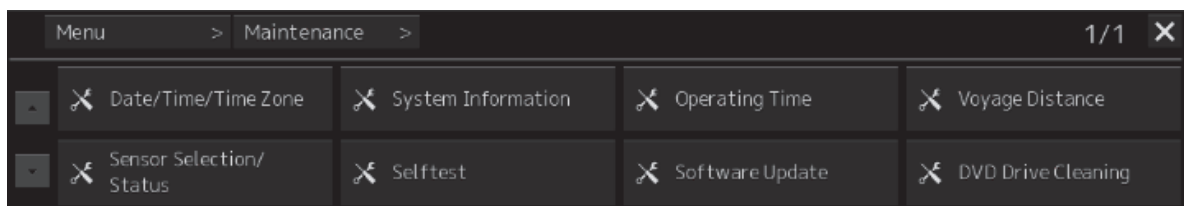

The [Software Update] dialog is displayed.

- 4 Click the [Help Install] button.**

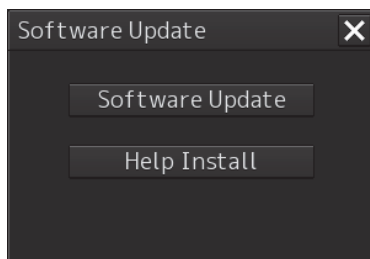

A file selection dialog is displayed.

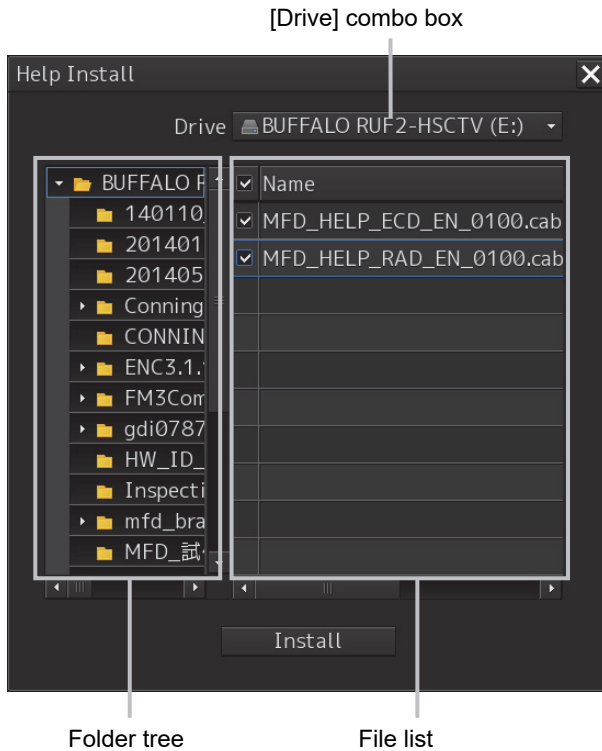

- 5** Select the drive containing update data from the [Drive] combo box.
- 6** Select the folder containing update data from the folder tree and check the file to be updated from the file list.
- 7** Click the [Install] button.

Installation starts and the following screen is displayed.

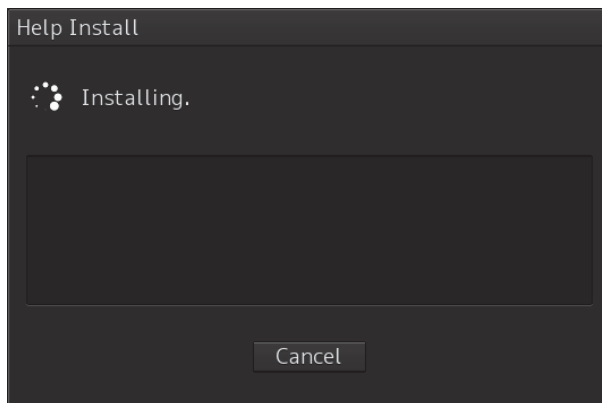

Wait until installation is completed.

When installation is completed, the following screen is displayed.

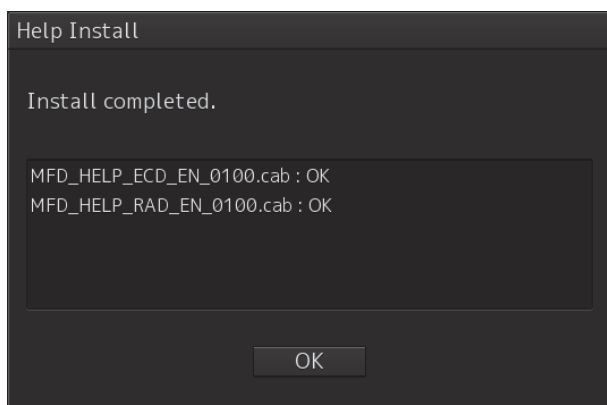

8 Click the [OK] button.

Memo

- When the [Cancel] button is clicked during installation, installation of subsequent files is cancelled after the installation of the file that is currently being installed is completed.
- When the selected update file already exists, the following screen is displayed.

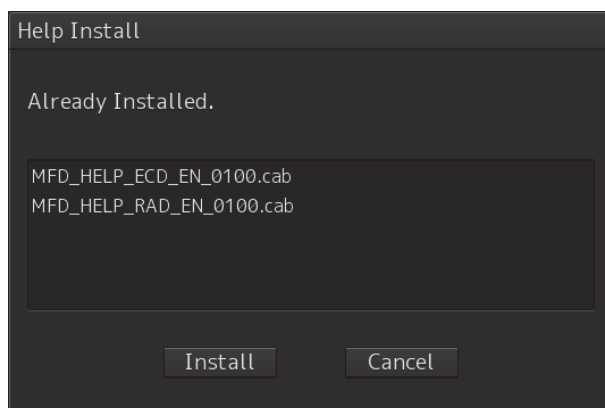

End the operation by clicking on the [Cancel] button.

19.9 Confirming Maintenance INFO

19.9.1 Screen items/fields and their function

Maintenance INFO can be confirmed.

- 1 Click on the [Menu] button on the left Tool Bar.
The menu is displayed.
- 2 Click on the [Maintenance] - [Maintenance INFO] button on the menu.

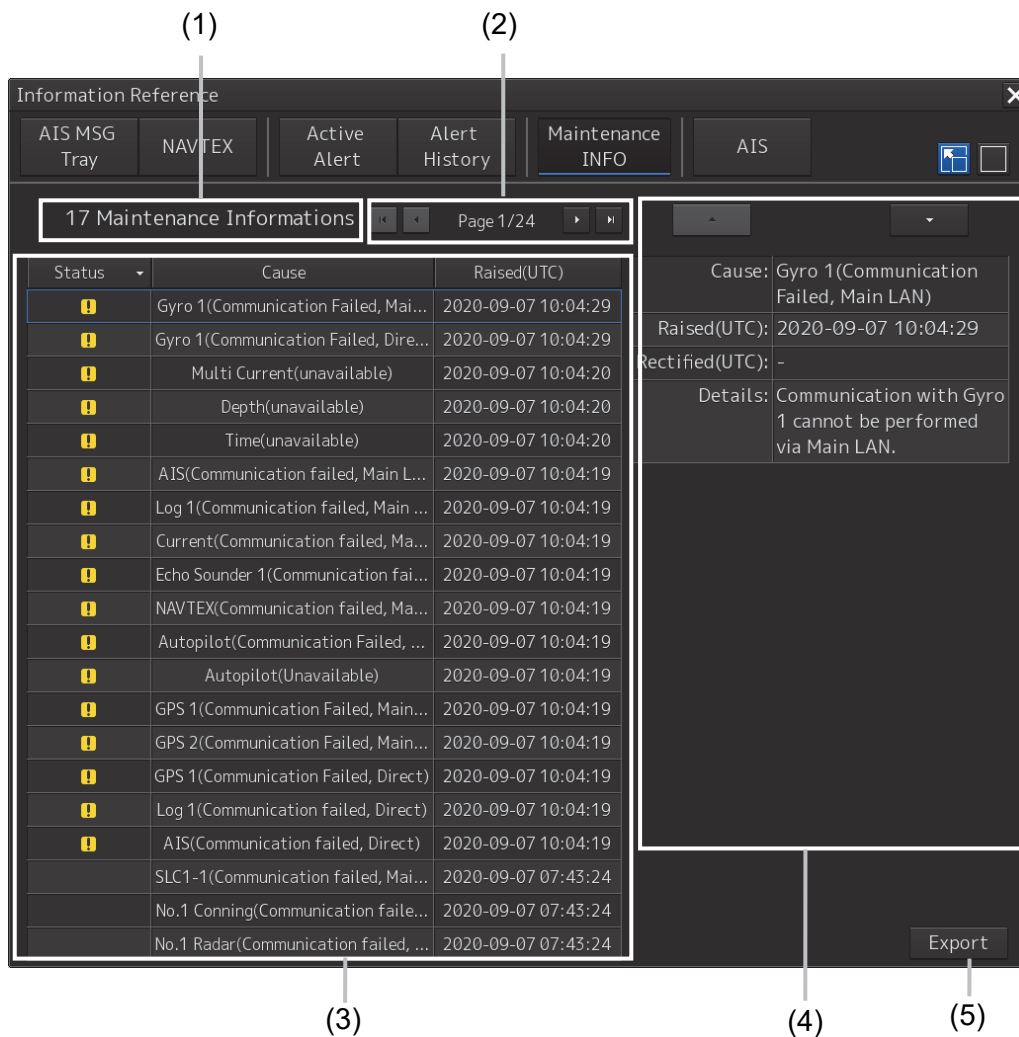

The screen can be switched to either the standard window or the expanded window.

An example of an expanded window is shown above.

For the screen switching method, refer to "19.9.2 Switching to the standard window or the expanded window"

(1) Number of pieces of maintenance information

The number of pieces of maintenance information being generated is displayed.

(2) Active page information

Up to twenty pieces of maintenance information can be displayed on a page. If maintenance information exceeds 20 pieces and is displayed over multiple pages, the pages are switched by operating the page change buttons.

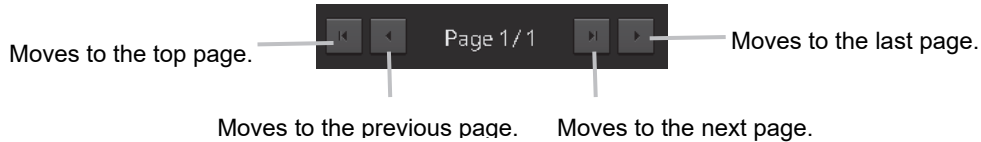

(3) Maintenance information list

Maintenance information being generated is displayed. Clicking any information selects the information.

- Details of the selected information are displayed in "(4) Detailed maintenance information."
- New maintenance information generated during screen display is added to the top of the list.
- Up to 1000 pieces of information can be displayed. When 1000 pieces are exceeded, information is sequentially deleted from the oldest information.
- Either of the following icons is displayed in the [Status] column.

: Generated

: Resolved

Blank: Maintenance information which had been generated before the MFD was restarted

- The [Cause] column shows the names of maintenance information.
- The [Raised(UTC)] column shows the generation time and date (UTC) of maintenance information.
- Clicking any item in the title line rearranges the list with reference to the clicked item.

Status ▾	Cause	Raised(UTC)
	Life Expectancy SSD1	2016-01-13 05:31:48
	Life Expectancy Magnetron1	2016-01-13 05:31:48
	Life Expectance UPS	2016-01-10 01:00:00

(4) Detailed maintenance information

Details of the currently selected maintenance information are displayed.

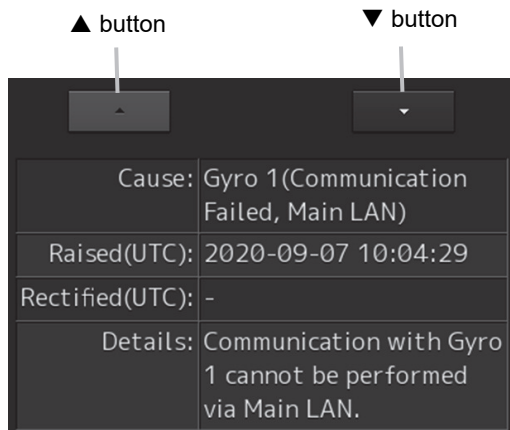

Information	Description
Cause	The cause of the maintenance information is displayed.
Raised(UTC)	The generation time and date (UTC) of the maintenance information is displayed.
Rectified(UTC)	The resolution time and date (UTC) of the maintenance information is displayed.
Details	Detailed information is displayed.

[▲] button

Clicking this button displays the details of the information with higher priority than currently displayed information.

[▼] button

Clicking this button displays the details of the information with lower priority than currently displayed information.

(5) **[Export] button**

Use this button to export maintenance information.

Refer to "19.8.3 Exporting maintenance information."

19.9.2 Switching to the standard window or the expanded window

The Maintenance INFO screen can be switched to either the standard window or the expanded window.

To switch to the expanded window, click the list expansion button.

To switch to the standard window, click the list standard button.



[Example of expanded window]

The screenshot shows the 'Maintenance INFO' window in its expanded state. It displays a table with 17 rows of maintenance information. The first row is selected, and its details are shown in a side panel on the right.

Status	Cause	Raised(UTC)
!	Gyro 1(Communication Failed, Mai...	2020-09-07 10:04:29
!	Gyro 1(Communication Failed, Dire...	2020-09-07 10:04:29
!	Multi Current(unavailable)	2020-09-07 10:04:20
!	Depth(unavailable)	2020-09-07 10:04:20
!	Time(unavailable)	2020-09-07 10:04:20
!	AIS(Communication failed, Main L...	2020-09-07 10:04:19
!	Log 1(Communication failed, Main ...	2020-09-07 10:04:19
!	Current(Communication failed, Ma...	2020-09-07 10:04:19
!	Echo Sounder 1(Communication fai...	2020-09-07 10:04:19
!	NAVTEX(Communication failed, Ma...	2020-09-07 10:04:19
!	Autopilot(Communication Failed, ...	2020-09-07 10:04:19
!	Autopilot(Unavailable)	2020-09-07 10:04:19
!	GPS 1(Communication Failed, Main...	2020-09-07 10:04:19
!	GPS 2(Communication Failed, Main...	2020-09-07 10:04:19
!	GPS 1(Communication Failed, Direct)	2020-09-07 10:04:19
!	Log 1(Communication failed, Direct)	2020-09-07 10:04:19
!	AIS(Communication failed, Direct)	2020-09-07 10:04:19
	SLC1-1(Communication failed, Mai...	2020-09-07 07:43:24
	No.1 Conning(Communication faile...	2020-09-07 07:43:24
	No.1 Radar(Communication failed, ...	2020-09-07 07:43:24

Details for the first entry:

- Cause: Gyro 1(Communication Failed, Main LAN)
- Raised(UTC): 2020-09-07 10:04:29
- Rectified(UTC): -
- Details: Communication with Gyro 1 cannot be performed via Main LAN.

[Example of standard window]

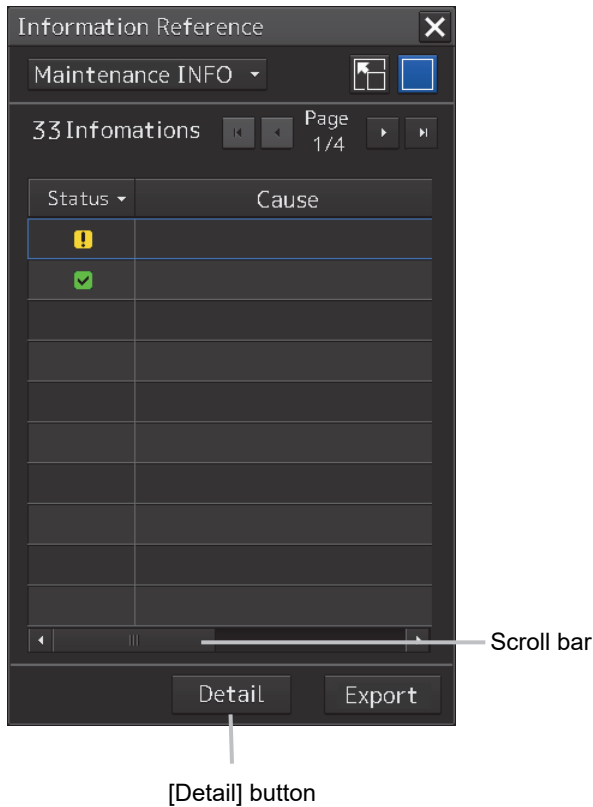

The standard window includes the list screen and the details screen.

To switch to the details screen, click the [Detail] button. Then, the [Detail] button turns into the [List] button.

To switch to the list screen, click the [List] button.

If the screen contents do not fit in the screen width, the scroll bar is displayed.

Dragging the scroll bar displays the contents not currently shown.

Memo

The initial display is shown in the expanded window.

19.9.3 Exporting maintenance information

Maintenance information can be exported as a CSV file to USB memory.

Information to be exported is that in the Cause, Raised(UTC), Rectified(UTC), and Detail fields.

1 Click the [Export] button on the Maintenance INFO screen.

The "Export" dialog box will appear.

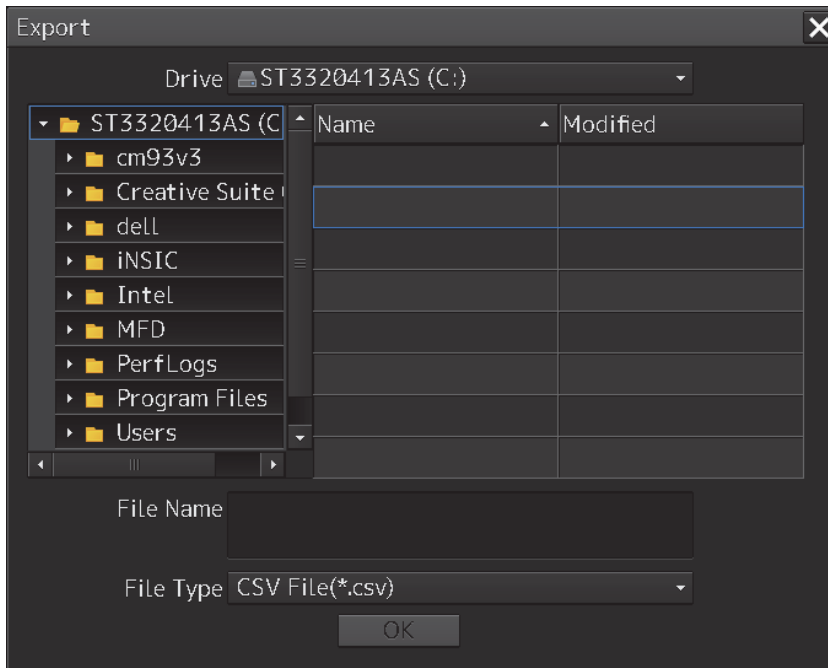

2 Specify the Drive (name of the drive for the USB memory) to which information is exported, Folder, and File Name.

Only [CSV File(*.csv)] can be selected for File Type.

3 Click the [OK] button.

To cancel information export, click the [x] button.

If a file with the same name exists:

The following pop-up window will appear.

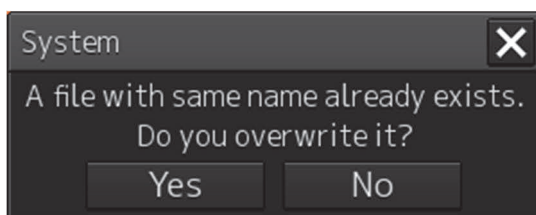

To cancel the export, click the [No] button.

To overwrite the existing file with the same file name, click the [Yes] button.

19.10 Data Backup/Restore

CAUTION



Do not turn off the power supply during backup/restore.
Otherwise, a function fault occurs, leading to the possibility of an accident.



Do not back up data during sailing.
To start backup data, the ECDIS application must be terminated. Otherwise, observation using the ECDIS is disabled, leading to the possibility of an accident.

19.10.1 Backing up data

To maintain customer data, back up the data regularly by using the following procedure.
Connect an external medium such as USB memory for backup.

- 1 Press the Power supply button of the operation unit.**
The power supply button is lit. Then, the task menu is displayed.
- 2 Click on the [Data Backup/Restore] button in the task menu.**

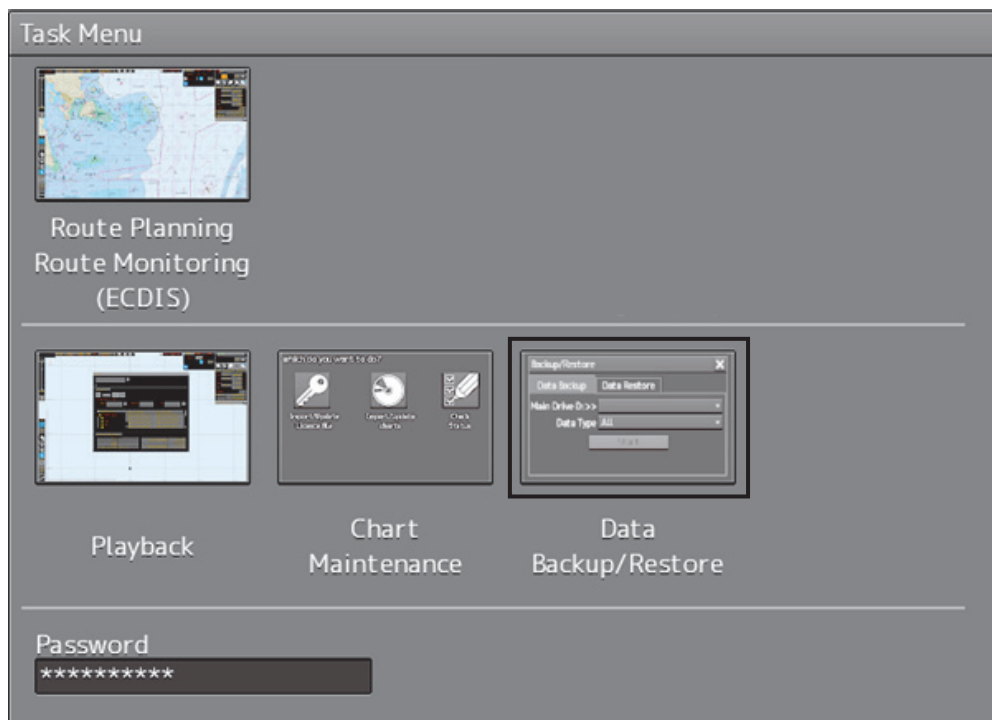

The [Backup/Restore] dialog is displayed.

3 Click on the [Data Backup] tab.

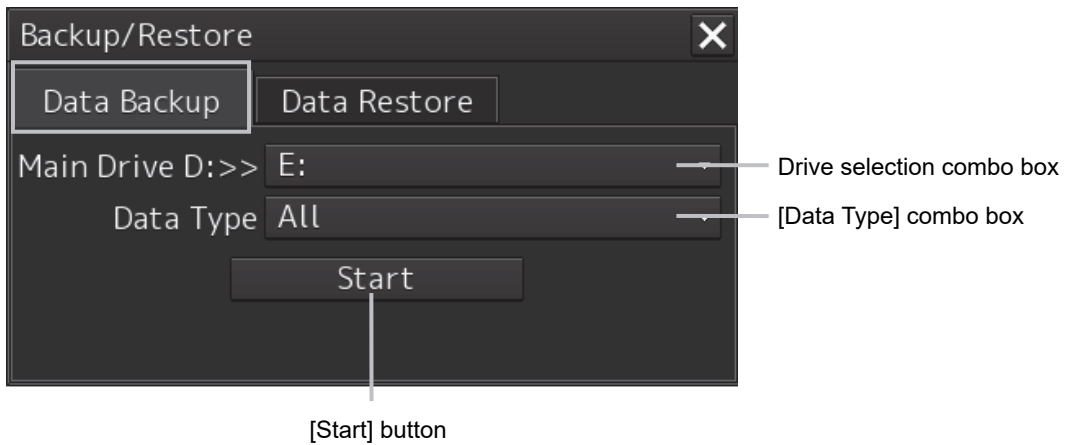

4 Select a drive of the data backup destination from the drive selection combo box.

5 Select the type of the data to be backed up in the [Data Type] combo box.

All: The entire user data is backed up.

Except Charts: The user data excluding chart data is backed up.

Note

When All is selected and there are many charts, backup operation may require a long period of time.

6 Click on the [Start] button.

A confirmation dialog is displayed.

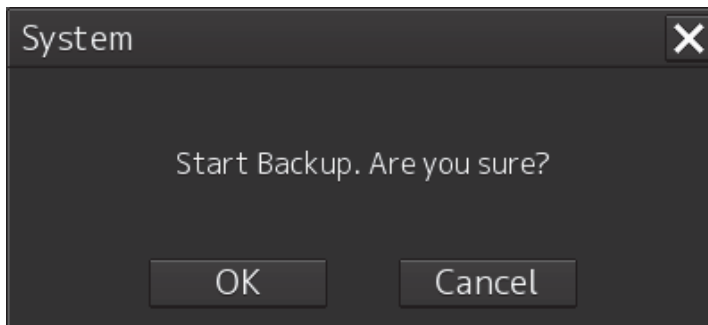

7 Click on the [OK] button.

Copying of data to the backup destination that is selected in the drive selection combo box starts.

Note

Do not perform any other operations until backup is completed. Otherwise, backup may fail.

19.10.2 Restoring backed up data

Use the following procedure to restore backed up data into this equipment.

Connect the external medium (USB memory, etc.) in which backup data has been saved.

- 1 Press the power supply button of the operation unit.**
The power supply button is lit. Then the task menu is displayed.
- 2 Click on the [Data Backup/Restore] button in the task menu.**

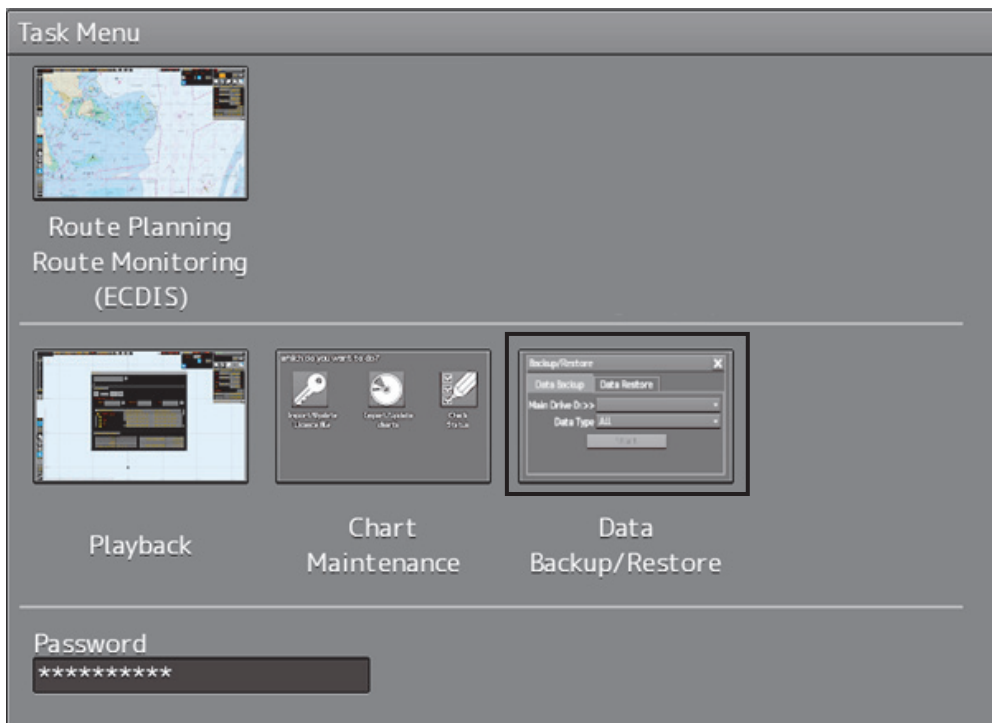

The [Backup/Restore] dialog is displayed.

- 3 Click on the [Data Restore] tab.**

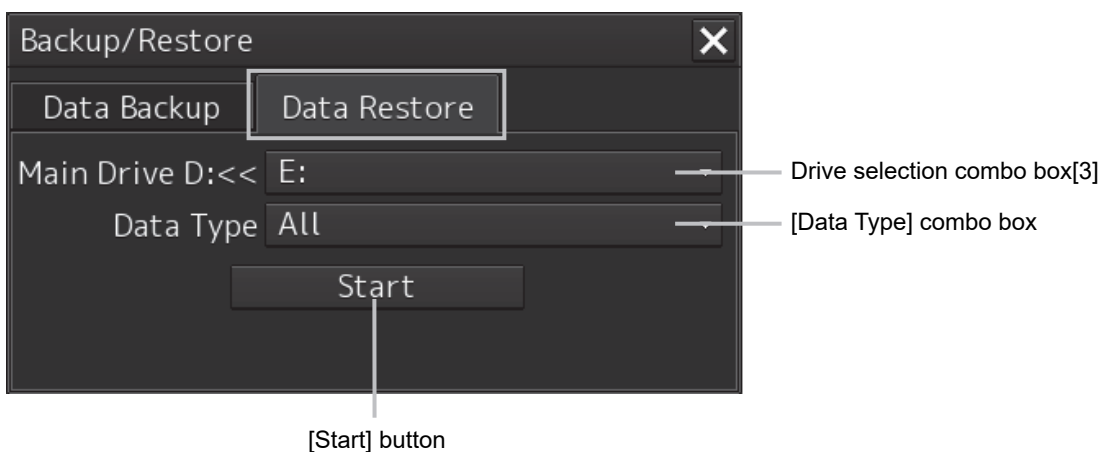

- 4 Select the drive in which backup data has been saved from the drive selection combo box.**
- 5 Select the type of the data to be restored in the [Data Type] combo box.**
All: The entire user data is restored.
Except Charts: The user data excluding chart data is restored.

6 Click on the [Start] button.

A confirmation dialog is displayed.

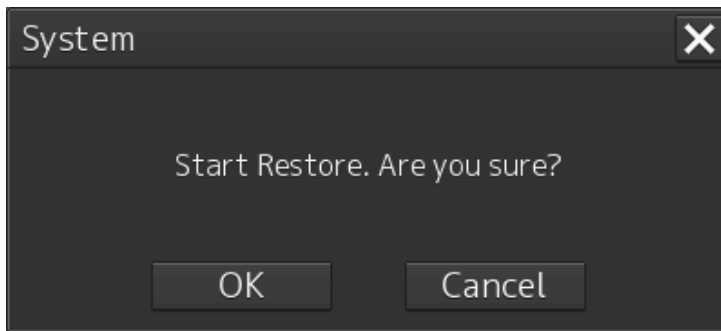

7 Click on the [OK] button.

Restoration of data from the drive that was selected from the drive selection combo box to the hard disk of this equipment starts.

If data already exists in the hard disk, an overwriting confirmation dialog is displayed.

To start restoration, click the [OK] button.

Note

- Do not perform any operation until restoration is completed. If some operation is performed, restoration may fail.
- If backup is executed while enough free space is not available in the USB memory, the "Error" message is displayed. Secure enough free space before executing backup. For the size of the data to be backed up, check the "Usage" column in the "File Information" list in "17.4.2 Managing storage". (For instance, when the AVCS chart for the entire world is installed, the size will be about 11GB.)

Memo

If the data to be restored is incompatible with this equipment, the following dialog is displayed and data is not restored.

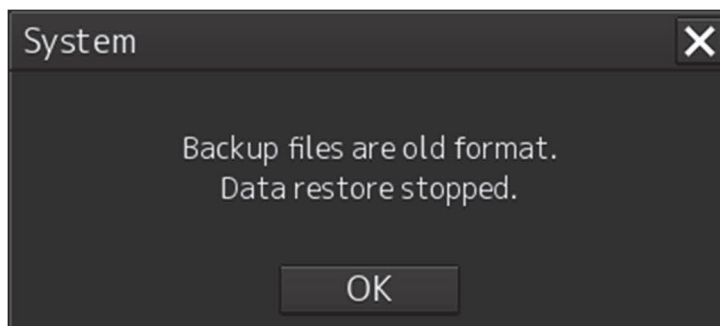

Cancel the task by clicking on the [OK] button.

19.11 Recovery of the Images in the C Drive

CAUTION



The backup power supply (DC power supply, etc.) of the equipment must be connected when recovery of the C drive image is performed. If the power supply stops during recovery, an accident may occur.



Do not turn off the power supply during recovery of the C drive image. Otherwise, equipment malfunction occurs, possibly causing an accident.

The operating system (OS) of this equipment runs on the C drive.

The contents of the C drive including the images are stored in the D drive.

When the OS operation on the C drive becomes unstable, the images in the C drive can be written back from the D drive.

Note

When the images in the C drive are written back, the information relating to C-MAP is cleared. After writing back of images, re-register the database and Licence of C-MAP and perform update as required.

The flow of writing back of images in the C drive is as follows.

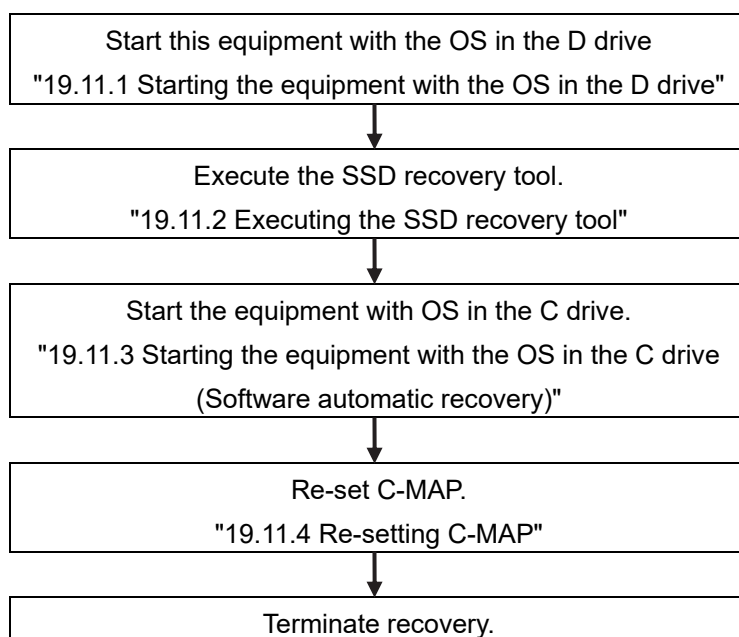

19.11.1 Starting the equipment with the OS in the D drive

Start this equipment with OS in the D drive by using the following procedure.

- 1 Turn on the power supply of this equipment while pressing the [SILENCE] key and the [ZOOM OUT] key of the trackball operation unit simultaneously. The power is supplied to this equipment.

When the equipment starts, the following screen is displayed.

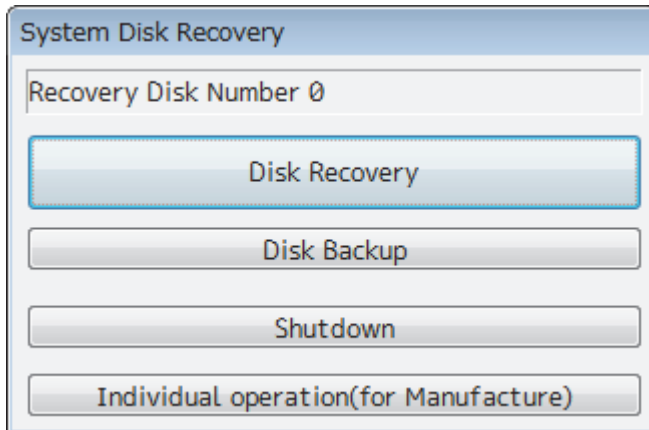

The SSD recovery tool can be executed in this state.

19.11.2 Executing the SSD recovery tool

Write back the images in the C drive by executing the SSD recovery tool.

- 1 Click on the [Disk Recovery] button on the screen that is displayed at activation from the D drive.

The following screen is displayed.

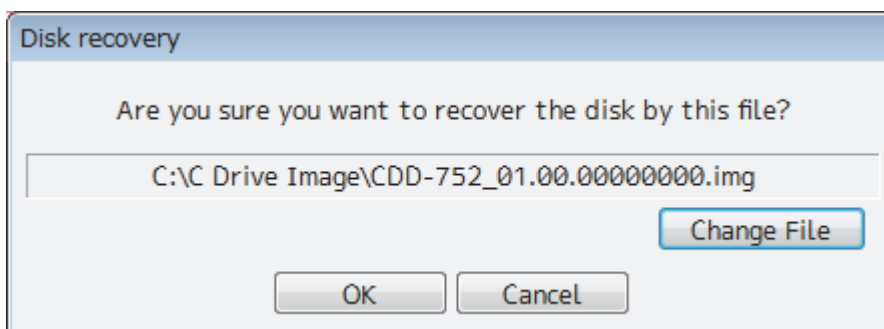

- 2 Select an image file to be written back to the C drive.

Normally, proceed with the next step with the image file that is currently displayed.

To specify a different image file, select a required image file from the list that is displayed by clicking on the [Change File] button.

Note

Since the equipment is started from the D drive, the usual C drive is displayed as the D drive and the usual D drive is displayed as C drive. Therefore, note this point when selecting an image file.

3 Click on the [OK] button.

Image file write-back operation starts.

Note

Do not perform any operation until write-back operation is completed. If any operation is performed, the image write-back operation may fail.

At termination of recovery, the following screen is displayed.

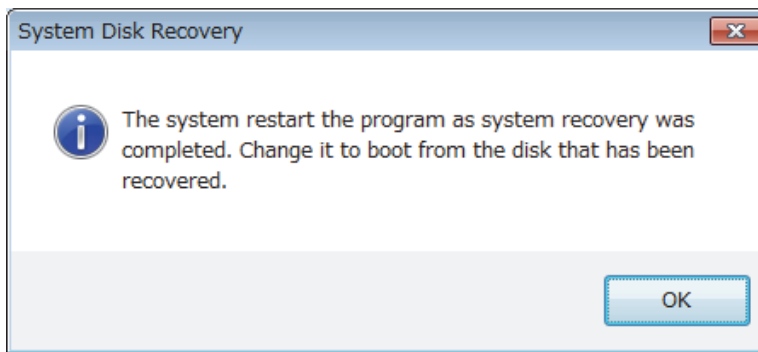

19.11.3 Starting the equipment with the OS in the C drive (Software automatic recovery)

Start this equipment with the OS that is written back to the C drive.

1 Click on the [OK] button on the screen that is displayed at termination of write-back operation.

The equipment starts from the C drive and, at the same time, the applications and various OS settings on the C drive are recovered automatically.

When recovery starts, the following screen is displayed for several seconds.

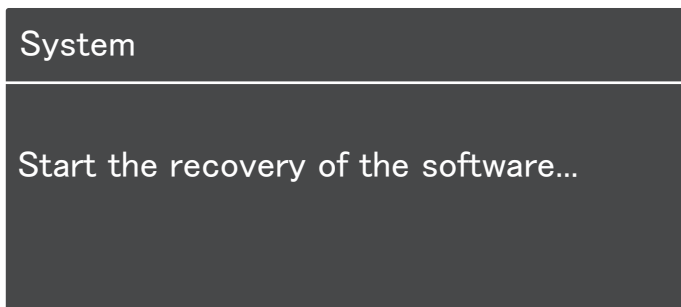
**Note**

This equipment restarts during the recovery operation. Do not perform any other operations until the recovery is completed.

Otherwise, recovery may fail, possibly causing an accident.

After completion of recovery, the following screen is displayed.

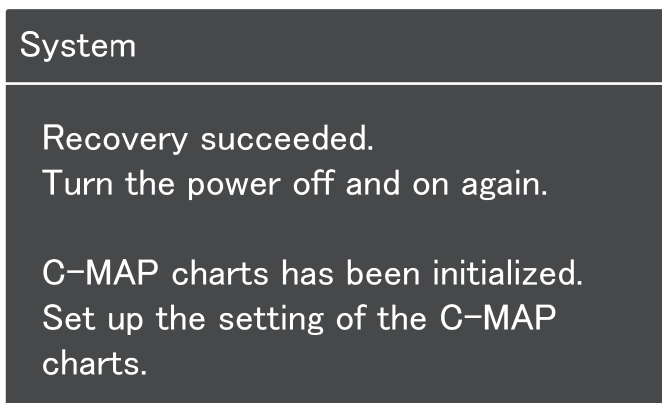

- 2 Turn off the power supply of this equipment by pressing the power button of the operation unit.**

19.11.4 Re-setting C-MAP

Re-set the settings of C-MAP by restarting this equipment.

Re-register the database and the Licence .

Update as required.



Section 20 Failures and After-Sale Services

20.1 Failure Detection

Semiconductor circuits can be considered to be almost free from defective semiconductors and/or performance deterioration except when there are design and inspection errors, or external and human induced causes. Generally, the causes of comparably frequent failures include line disconnection due to humidity of the high resistor, failure of the variable resistor as well as contact failures of switches and relays.

In addition to faulty parts, faulty adjustments (especially faulty tuning) or faulty maintenance (especially faulty cable contact) occasionally make up causes of failures; thus, it is effective to reinspect or readjust these items.

20.1.1 About alerts

Failures can be detected from alerts.

For details on alerts, please refer to "Appendix A, Alert List."

20.1.2 Alert description

For a description of alerts to be displayed, please refer to "Appendix A, Alert List."

20.1.3 S-57/63 chart related error message list

For more information about error messages that are displayed when the S-57/63 charts are imported and updated on the ECDIS, please refer to "Reference Data 1: Notes on Alert Information of the S-57/63 Charts" in the Instruction Manual provided separately from charts.

20.1.4 ARCS chart related error message list

For more information about error messages that are displayed when the ARCS charts are displayed on the ECDIS, please refer to "Reference Data 2: Notes on Alert Information of the ARCS Charts" in the Instruction Manual provided separately from charts.

20.1.5 Fuse inspection

Because there is a specific cause for any fuse meltdown, it is necessary to check the related circuits even if there is no abnormality after changing a fuse. However, please give consideration that the fuse meltdown characteristics vary significantly. The following table shows a list of the fuses used in this unit.

List of Fuses Used

Fuse Name	Name of Model Used	Placement Location	Count	Part Spec.	Change Kit Model Name
Blade fuse (Auto fuse)	NBD-913	Power supply unit	2	32VDC 15A part	1015(5ZFCK00008)
Blade (mini) fuse (Auto fuse)	NQE-1143	JB	1	32VDC 15A part	1215(5ZFCK00017)
Blade (mini) fuse (Auto fuse)			2	32VDC 3A part	1203(5ZFCK00016)
Glass fuse			4	250V 0.5A part	MF51NR 250V 0.5(5ZFGD00019)

20.2 Countermeasures for Failures

20.2.1 Repair circuit block

Repair Circuit Block (JAN-9201S)

Location	Circuit Block Name	Model Name	Remarks
Display unit	Display unit	NWZ-208	
Display unit	FAN kit for changing the 26inch MNU	7ZYNA4005	
Trackball operation unit	Trackball unit	CCK-1060	
Trackball operation unit	Operation circuit A	CCK-1050	
Trackball operation unit	Operation circuit SW	CCK-1069	
Trackball operation unit	Operation circuit CN	CCK-1070	
Keyboard operation unit	Operation circuit B	CCK-1059	
Keyboard operation unit	Keyboard unit	CCK-1061	
Keyboard operation unit	φ38 knob	MPHD30460	
Keyboard operation unit	φ22 knob	MPHD30459	
Power supply unit	Power supply unit	NBD-913	
Power supply unit	PSU replacement FAN kit	7ZYNA4007	
Central control unit	CCU repair kit	NZC-1590/A	
Central control unit	SSD 256GB	CDD-753/A	
Central control unit	DVD drive	CDD-754	
Central control unit	FAN kit for changing the CCU	7ZYNA4006	

Repair Circuit Block (JAN-7201S)

Location	Circuit Block Name	Model Name	Remarks
Display unit	Display unit	NWZ-207	
Display unit	FAN kit for changing the 19inch MNU	7ZYNA4004	
Display unit	Display unit	NWZ-214	
Display unit	FAN kit for changing the 19inch MNU	7BFRD0008	For NWZ-214
Trackball operation unit	Trackball unit	CCK-1060	
Trackball operation unit	Operation circuit A	CCK-1050	
Trackball operation unit	Operation circuit SW	CCK-1069	
Trackball operation unit	Operation circuit CN	CCK-1070	
Trackball operation unit	Interior of the trackball operation unit	CMD-1103	
Keyboard operation unit	Operation circuit B	CCK-1059	
Keyboard operation unit	Keyboard unit	CCK-1061	
Keyboard operation unit	Interior of the keyboard operation unit	CMD-1106	
Power supply unit	Power supply unit	NBD-913	
Central control unit	CCU repair kit	NZC-1590/A	
Central control unit	SSD 256GB	CDD-753/A	
Central control unit	DVD drive	CDD-754	
Central control unit	FAN kit for changing the CCU	7ZYNA4006	
Central control unit	Lower screw cover	MTV305169	
Central control unit	Upper screw cover	MTV305170	
Central control unit	Serial LAN interface circuit	CMH-2370	
Central control unit	Gyro interface circuit	CMJ-554	
Central control unit	Analog option circuit	CMJ-560	

20.3 Troubleshooting

When this equipment does not operate correctly, check the following points before asking for repairs. Consult with your nearest subsidiary company, branch office, or sales office if the problem does not get solved even after checking and correcting these points, or if there are any abnormally locations other than the following items.

Symptom	Cause	Action
The power is not supplied. Alternatively, the equipment does not start even if the Power button of the operation unit is pressed.	The AC or DC power supply is not connected.	Connect the AC or DC power supply.
	The breaker at the front of the power supply unit (NBD-913) is not set to ON.	Set the breaker to ON by pushing up the lever of the breaker.
	The AC or DC power supply is not input within the specified voltage range.	Connect the AC or DC power supply within the specified voltage range.
	The internal wiring is faulty.	Make a request to the distributor for repair.
	The power supply unit (NBD-913) is faulty.	Make a request to the distributor for repair.
	The central control unit (NDC-1590E/AE) is faulty.	Make a request to the distributor for repair.
	The operation unit (NCE-5605) is faulty.	Make a request to the distributor for repair.
The power is not supplied to the monitor.	The display unit is not activated.	Activate the display unit.
	The internal wiring is faulty.	Make a request to the distributor for repair.
	The display (NWZ-208/NWZ-207/NWZ-214) is faulty.	Make a request to the distributor for repair.
Although the power is supplied to the monitor, the screen is not displayed.	The brightness of the monitor is set to the minimum level.	Adjust the brightness of the monitor to the appropriate level.
	The internal wiring is faulty.	Make a request to the distributor for repair.
	The display (NWZ-208/NWZ-207/NWZ-214) is faulty.	Make a request to the distributor for repair.
The brightness of the monitor cannot be adjusted.	The display (NWZ-208/NWZ-207/NWZ-214) is faulty.	Make a request to the distributor for repair.
The trackball or the option keyboard cannot be operated.	The internal wiring is faulty.	Make a request to the distributor for repair.
	The operation unit (NCE-5605/NCE5625) is faulty.	Make a request to the distributor for repair.

Symptom	Cause	Action
The trackball does not move smoothly.	The trackball is dirty.	Clean the trackball.
Although the power is supplied and the screen is displayed, the display is frozen, disabling processing to advance up to display of the task menu.	The central control unit (NDC-1590E/AE) is abnormal.	Make a request to the distributor for repair.
Some task menus cannot be selected.	The device license has not been installed.	Install the license of the device to be used.
The cursor is not displayed correctly.	The central control unit (NDC-1590E/AE) is faulty.	Make a request to the distributor for repair.
Characters/symbols are not displayed correctly.	The central control unit (NDC-1590E/AE) is faulty.	Make a request to the distributor for repair.
Position information (GPS) is not displayed.	The communication is not set correctly.	Set the communication correctly.
	The power supply for the GPS equipment is not turned on.	Turn on the power supply for the GPS equipment.
	The GPS equipment does not perform positioning.	Check the state of the GPS equipment.
	The connection with the GPS equipment is abnormal.	Check the connection with the GPS equipment. When GPS equipment is connected to the serial LAN interface circuit, check if the LED of the corresponding port is lit at data reception.
	The power supply for the serial-LAN interface circuit (CMH-2370) is not turned on. (Case where the GPS equipment is connected to the serial-LAN interface circuit)	Turn on the power supply for the serial-LAN interface circuit.
	The serial-LAN interface circuit (CMH-2370) is faulty. (Case where the GPS equipment is connected to the serial-LAN interface circuit)	Make a request to the distributor for repair.
	The internal wiring is faulty.	Make a request to the distributor for repair.
	The central control unit (NDC-1590E/AE) is faulty.	Make a request to the distributor for repair.

Symptom	Cause	Action
AIS information is not displayed.	The communication is not set correctly.	Set the communication correctly.
	The power supply for the AIS equipment is not turned on.	Turn on the power supply for the AIS equipment.
	The AIS equipment does not perform positioning.	Check the state of the AIS equipment.
	The connection with the AIS equipment is abnormal.	Check the connection with the AIS equipment. When AIS equipment is connected to the serial LAN interface circuit, check if the LED of the corresponding port is lit at data reception.
	The power supply for the serial-LAN interface circuit (CMH-2370) is not turned on. (Case where the AIS equipment is connected to the serial-LAN interface circuit)	Turn on the power supply for the serial-LAN interface circuit.
	The serial-LAN interface circuit (CMH-2370) is faulty. (Case where the AIS equipment is connected to the serial-LAN interface circuit)	Make a request to the distributor for repair.
	The internal wiring is faulty.	Make a request to the distributor for repair.
	The central control unit (NDC-1590E/AE) is faulty.	Make a request to the distributor for repair.

Symptom	Cause	Action
<p>The azimuth of the Gyro compass is not displayed.</p> <p>Alternatively, the azimuth rotation direction is not displayed correctly.</p>	<p>The communication is not set correctly.</p>	<p>Set the communication correctly.</p>
	<p>The power supply for the Gyro compass equipment is not turned on.</p>	<p>Turn on the power supply for the Gyro compass equipment.</p>
	<p>The connection with the Gyro compass equipment is abnormal.</p>	<p>Check the connection with the Gyro compass equipment.</p> <p>When gyro compass equipment is connected to the serial LAN interface circuit or gyro interface circuit, check if the corresponding LED is lit at signal reception.</p>
	<p>The power supply for the serial-LAN interface circuit (CMH-2370) is not turned on.</p> <p>(Case where the Gyro compass equipment is connected to the serial-LAN interface circuit)</p>	<p>Turn on the power supply for the serial-LAN interface circuit.</p>
	<p>The serial-LAN interface circuit (CMH-2370) is faulty.</p> <p>(Case where the Gyro compass equipment is connected to the serial-LAN interface circuit)</p>	<p>Make a request to the distributor for repair.</p>
	<p>The Gyro interface circuit (CMJ-554) is not set correctly</p> <p>(Case where the Gyro compass equipment is connected to the Gyro interface circuit)</p>	<p>Set the Gyro interface circuit correctly according to the Gyro compass equipment.</p>
	<p>The fuse of the gyro interface circuit (CMJ-554) has blown.</p>	<p>Replace the fuse of the gyro interface circuit.</p>
	<p>The Gyro interface circuit (CMJ-554) is faulty.</p> <p>(Case where the Gyro compass equipment is connected to the Gyro interface circuit)</p>	<p>Make a request to the distributor for repair.</p>
	<p>The internal wiring is faulty.</p>	<p>Make a request to the distributor for repair.</p>
<p>The central control unit (NDC-1590E/AE) is faulty.</p>	<p>Make a request to the distributor for repair.</p>	

Symptom	Cause	Action
Log is not displayed or the values are not displayed correctly.	The communication is not set correctly.	Set the communication correctly.
	The power supply for the log equipment is not turned on.	Turn on the power supply for the log equipment.
	The connection with the log equipment is abnormal.	Check the connection with the log equipment. When log equipment is connected to the serial LAN interface circuit or gyro interface circuit, check if the corresponding LED blinks at signal reception.
	The power supply for the serial-LAN interface circuit (CMH-2370) is not turned on. (Case where the log equipment is connected to the serial-LAN interface circuit).	Turn on the power supply for the serial-LAN interface circuit.
	The serial-LAN interface circuit (CMH-2370) is faulty. (Case where the log equipment is connected to the serial-LAN interface circuit).	Make a request to the distributor for repair.
	The Gyro interface circuit (CMJ-554) is not set correctly. (Case where the log equipment is connected to the Gyro interface circuit).	Set the Gyro interface circuit correctly according to the log equipment.
	The Gyro interface circuit (CMJ-554) is faulty. (Case where the log equipment is connected to the Gyro interface circuit).	Make a request to the distributor for repair.
	The internal wiring is faulty.	Make a request to the distributor for repair.
The central control unit (NDC-1590E/AE) is faulty.	Make a request to the distributor for repair.	

Symptom	Cause	Action
Rudder angles are not displayed. Alternatively, the values are not displayed correctly.	The communication is not set correctly.	Set the communication correctly.
	The power supply for the rudder angle indicator is not turned on.	Turn on the power supply for the rudder angle indicator.
	The connection with the rudder angle indicator is abnormal.	Check the connection with the rudder angle indicator. When a rudder angle indicator is connected to the serial LAN interface circuit, check if the LED of the corresponding port is lit at data reception.
	The power supply for the serial-LAN interface circuit (CMH-2370) is not turned on. (Case where the rudder angle indicator is connected to the serial-LAN interface circuit or the rudder angle indicator is connected to the analog option circuit)	Turn on the power supply for the serial-LAN interface circuit.
	The serial-LAN interface circuit (CMH-2370) is faulty. (Case where the rudder angle indicator is connected to the serial-LAN interface circuit or the rudder angle indicator is connected to the analog option circuit)	Make a request to the distributor for repair.
	The analog option circuit (CMJ-560) is not set correctly. (Case where the rudder angle indicator is connected to the analog option circuit)	Set the analog option circuit correctly according to the rudder angle indicator.
	The analog option circuit (CMJ-560) is faulty. (Case where the rudder angle indicator is connected to the analog option circuit)	Make a request to the distributor for repair.
	The internal wiring is faulty.	Make a request to the distributor for repair.
The central control unit (NDC-1590E/AE) is faulty.	Make a request to the distributor for repair.	

Symptom	Cause	Action
Wind direction/wind speed (anemoscope/anemometer) data is not displayed.	The communication is not set correctly.	Set the communication correctly.
	The power supply for the anemoscope/anemometer is not turned on.	Turn on the power supply for the anemoscope/anemometer.
	The connection with the anemoscope/anemometer is abnormal.	Check the connection with the anemoscope/anemometer. Check if the LED of the corresponding port of the serial LAN interface circuit is lit at data reception.
	The power supply for the serial-LAN interface circuit (CMH-2370) is not turned on.	Turn on the power supply for the serial-LAN interface circuit.
	The serial-LAN interface circuit (CMH-2370) is faulty.	Make a request to the distributor for repair.
	The internal wiring is faulty.	Make a request to the distributor for repair.
	The central control unit (NDC-1590E/AE) is faulty.	Make a request to the distributor for repair.
Water depth values are not displayed.	The communication is not set correctly.	Set the communication correctly.
	The power supply for the echo sounder is not turned on.	Turn on the power supply for the echo sounder.
	The connection with the echo sounder is abnormal.	Check the connection with the echo sounder. Check if the LED of the corresponding port of the serial LAN interface circuit is lit at data reception.
	The power supply for the serial-LAN interface circuit (CMH-2370) is not turned on.	Turn on the power supply for the serial-LAN interface circuit.
	The serial-LAN interface circuit (CMH-2370) is faulty.	Make a request to the distributor for repair.
	The internal wiring is faulty.	Make a request to the distributor for repair.
	The central control unit (NDC-1590E/AE) is faulty.	Make a request to the distributor for repair.

Symptom	Cause	Action
Sensor signals are not displayed.	The communication is not set correctly.	Set the communication correctly.
	The power supply for the sensor equipment is not turned on.	Turn on the power supply for the sensor equipment.
	The connection with the sensor equipment is faulty.	Check the connection with the sensor equipment. Check if the LED of the corresponding port of the serial LAN interface circuit is lit at data reception.
	The power supply for the serial-LAN interface circuit (CMH-2370) is not turned on.	Turn on the power supply for the serial-LAN interface circuit.
	The internal wiring is faulty.	Make a request to the distributor for repair.
	The indicator such as the serial-LAN interface circuit (CMH-2370), analog option circuit (CMJ-560), and central control unit (NDC-1590E/AE) is faulty.	Make a request to the distributor for repair.
Autopilot is disabled.	The communication is not set correctly.	Set the communication correctly.
	The autopilot function is not operated correctly.	Operate autopilot correctly.
	The power supply for the autopilot equipment is not turned on.	Turn on the power supply for the autopilot equipment.
	The connection with the autopilot equipment is faulty.	Check the connection with the autopilot equipment. Check if the LED of the corresponding port of the serial LAN interface circuit is lit at data reception.
	The power supply for the serial-LAN interface circuit (CMH-2370) is not turned on.	Turn on the power supply for the serial-LAN interface circuit.
	The serial-LAN interface circuit (CMH-2370) is faulty.	Make a request to the distributor for repair.
	The internal wiring is faulty.	Make a request to the distributor for repair.
	The central control unit (NDC-1590E/AE) is faulty.	Make a request to the distributor for repair.

Symptom	Cause	Action
Contact signals are not output.	The power supply for the serial-LAN interface circuit (CMH-2370) is not turned on. (Case where contact signal output is acquired from the serial-LAN interface circuit)	Turn on the power supply for the serial-LAN interface circuit.
	The serial-LAN interface circuit (CMH-2370) is faulty. (Case where contact signal output is acquired from the serial-LAN interface circuit)	Make a request to the distributor for repair.
	The internal wiring is faulty.	Make a request to the distributor for repair.
	The central control unit (NDC-1590E/AE) is faulty.	Make a request to the distributor for repair.
If the power supply is turned off, the track data is cleared without being stored.	The central control unit (NDC-1590E/AE) is faulty.	Make a request to the distributor for repair.
UPS does not function.	The connection with UPS is faulty.	Check the connection with UPS.
	UPS is not set correctly.	Set UPS correctly.
	The UPS battery is extremely depleted.	Replace the battery. [Note] At the battery replacement, make a request for the work to the specialized service staff. During the replacement, turn off the corresponding power supply breaker in the ship. Otherwise, an unexpected accident may occur.
	The internal wiring is faulty.	Make a request to the distributor for repair.
	UPS is faulty.	Make a request to the distributor for repair.

Symptom	Cause	Action
The following popup window is displayed. System has detected an error. Turn the power off and on again.	A communication error occurred.	Close the popup window and after checking that there is no problem even if the power of this equipment is turned off, turn off the power once and turn on the power again.
The system repeats restart.	DMA error.	When the system repeats restart, turn off the power of the equipment and contact the distributor.

20.4 After-Sale Services

20.4.1 About the retaining period of service parts

The retaining period of the performance-critical parts for servicing this product (parts required to maintain the functionality of the product) is 10 years after the discontinuation of production.

20.4.2 When requesting a repair

If you suspect a failure, please read "20.3 Troubleshooting" thoroughly and check the unit again.

If you still detect abnormality, stop using the product and contact your sales representative, our sales department, nearest branch office or sales office.

- **Repair during the warranty period:** If a failure occurs in the course of using the product correctly according to the explanations and instructions in the Instruction Manual, your sales representative or our company shall repair the product at no charge. However, repairs of failures caused by misuse, negligence, or act of God such as natural disasters and fire shall be chargeable.
- **If the warranty period has expired:** If functionality can be recovered by repair, repair shall be made by the request of the customer for a fee.
- **Please provide the following information:**
 - Product name, model name, manufacturing date, serial number
 - Description of abnormality (as detail as possible) (Please refer to the next page "ECDIS Failure Checklist.")
 - Business name or organization name, address, phone number

20.4.3 Recommendation of inspection and maintenance

Although it depends on the usage state, performance may deteriorate by change in parts over time, Separately from regular care, inspection and maintenance are recommended.

Regarding inspection and maintenance, please contact your sales representative, our sales department, nearest branch office or sales office.

Please note that there is a charge for inspection and maintenance.

If you have questions regarding after-sale services, please inquire your sales representative, our sales department, nearest branch office or sales office.

ECDIS Failure Checklist

[Important] Before ordering a repair, please check and fill in the following items and then contact the applicable repair office.

If there are unknown items, please contact the ship and fill in as accurate as possible.

Ship Name: _____ Phone: _____ Fax: _____

Integrated Radar Model Name: JMR- _____ Serial Number: _____

(Please fill in all digits accurately.)

(1) Check the following items sequentially and circle either YES or NO for each item.

If none is applicable, please write down the specific reason in No. (8) Others.

No.	Check Item	Result	
		YES	NO
(1)	The power turns ON. (The light of the operation unit illuminates.)		
(2)	The starting screen is displayed.		
(3)	The task screen is displayed.		
(4)	The ECDIS screen is displayed.		
(5)	Operation using the trackball or keyboard is possible.		
(6)	Range changing or movement of the chart can be done smoothly.		
(7)	The various sensors are displayed normally.		
(8)	Others (error messages, etc.)		

20.4.4 Extending the functions

The functions that are available for this equipment can be extended.

To extend a function, new license information (file) must be obtained and imported to this equipment. For function extension, please request to our sales department or our branch office, sales office, or agent near your premises.

20.4.4.1 Importing the license information

Import the license information that was obtained (license file) to this equipment via the USB flash memory.

Connect the USB flash memory in which the license information is stored.

1 Press the Power button of the operation unit.

The Power button is lit. After a while, a task menu is displayed.

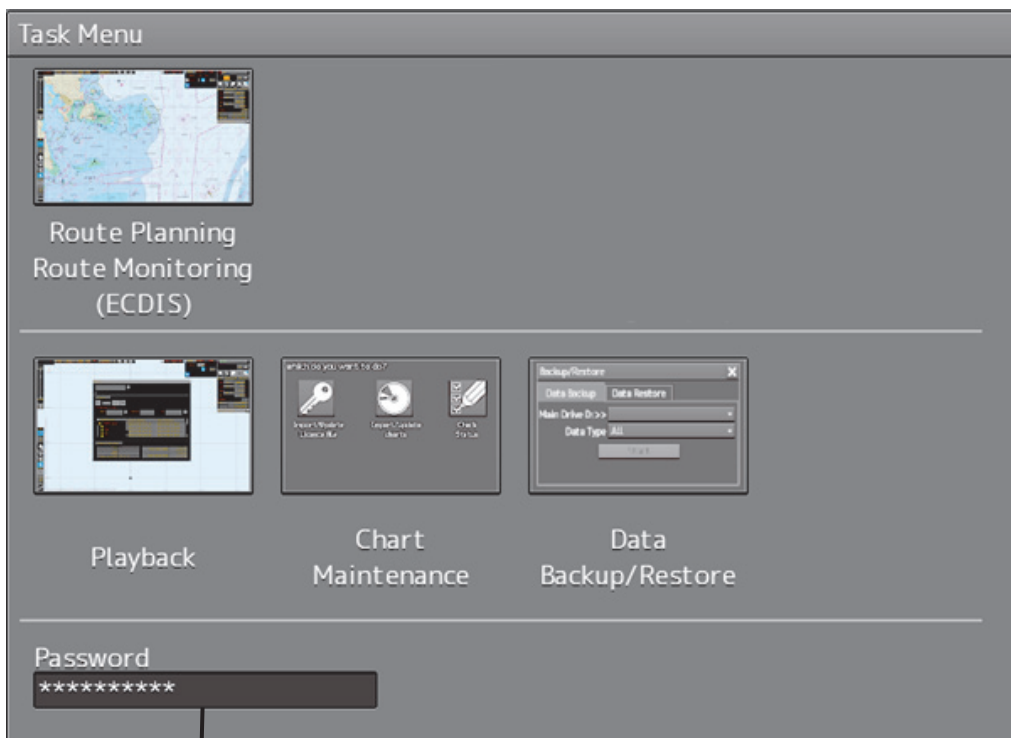

Password input section

2 Click on the password input section.

A password input dialog is displayed.

3 Enter the password, 9380.

The [Import License] dialog is displayed.

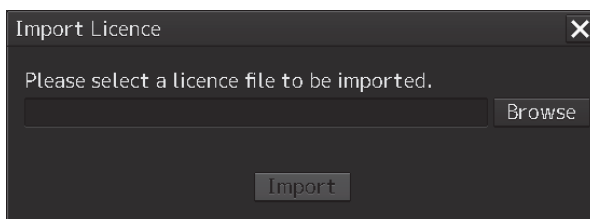

4 Click on the [Browse] button.

The [System] dialog is displayed.

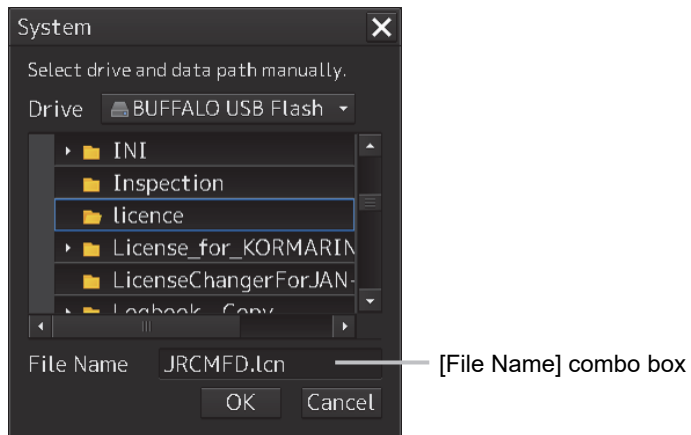

5 Select the name of the license file (example: JRCMFD.lcn) that is stored in the USB flash memory from the [File Name] combo box and click on the [OK] button.

The [System] dialog is closed.

6 Click on the [Import] button.

When import is completed, a confirmation dialog box appears.

Close the dialog box by clicking on the [OK] button.

7 Close the [Import License] dialog box by clicking on [x] button and return to the task menu.

In this case, a new license is adopted.

Section 21 About Disposal

21.1 About Disposal of This Equipment

When disposing of this equipment, follow the regulations and/or rules of the local regulatory authority which has control over the location of disposal.

21.2 Chinese Version RoHS

有毒有害物质或元素的名称及含量

(Names & Content of toxic and hazardous substances or elements)

形式名(Type): JAN-9201S, JAN-7201S

名称(Name): ECDIS

部件名称 (Part name)	有毒有害物质或元素 (Toxic and Hazardous Substances and Elements)					
	铅 (Pb)	汞 (Hg)	镉 (Cd)	六价铬 (Cr6+)	多溴联苯 (PBB)	多溴二苯醚 (PBDE)
主船内装置 (Inboard Unit) · 显示装置 (Display Unit) · 键盘装置 (OperationUnit) · 信号处理装置 (Central Control Unit)	×	×	○	×	○	○
外部设备 (Peripherals) · 选择 (Options) · 电线类 (Cables) · 手册 (Documennts)	×	×	○	×	○	○
<p>○: 表示该有毒有害物质在该部件所有均质材料中的含量均在 SJ/T11306-2006 标准规定的限量要求以下。 (Indicates that this toxic, or hazardous substance contained in all of the homogeneous materials for this part is below the requirement in SJ/T11363-2006.)</p> <p>×: 表示该有毒有害物质至少在该部件的某一均质材料中的含量超出 SJ/T11363-2006 标准规定的限量要求。 (Indicates that this toxic or hazardous substance contained in at least one of the homogeneous materials used for this part is above the limit requirement in SJ/T 11363-2006.)</p>						

Section 22 Specifications

22.1 JAN-9201S

GENERAL SPECIFICATION	JAN-9201S
Display	26inch Wide LCD
Bearing Indication	Relative motion mode: North UP/Course UP/Head UP/Waypoint UP True motion mode: North UP/Course UP/Waypoint UP
Operation	Cursor and keys
External media	General purpose USB port × 1 and DVD drive
Ambient Condition	-15°C to +55°C (Storage: -25°C to +70°C)
- Operating Temperature	
Ambient Condition	+40°C, 93%
- Relative Humidity	
Ambient Condition	2 to 13.2Hz: Amplitude ±1mm ±10%
- Vibration	13.2 to 100Hz: Acceleration 7m/s ²
Power Supply Input	100 to 115VAC, 50/60Hz 1φ 220 to 240VAC, 50/60Hz 1φ 24VDC
Power Consumption	Rating: Approx. 240VA (DC:72W at AC power outage)
Power Supply Voltage Fluctuation	AC input: ±10% DC input: +30%, -10%
Processing Unit	
Central Control Unit	NDC-1590E/AE
Power Supply Unit	NBD-913
Trackball Operation Unit	NCE-5605
Display	
Display	NWZ-208
Option Unit	
Keyboard Operation Unit	NCE-5625
Operation Unit Desktop Frame Rack	CWB-1596
Large tray	CWB-1593
Junction Box	NQE-1143
Sensor LAN Switch Unit	NQA-2443/A
26inch Desktop Frame Rack	CWB-1595
26inch Display Unit Mount Kit	CWA-246
Buzzer unit	CGC-25
Safe Distance For Standard Compass	
Display unit	2.4m (2.6m when installed in the optional 26inch Display Unit Mount Kit)

22.2 JAN-7201S

GENERAL SPECIFICATION	JAN-7201S
Display	19inch LCD
Bearing Indication	Relative motion mode: North UP/Course UP/Head UP/Waypoint UP True motion mode: North UP/Course UP
Operation	Cursor and keys
External media	General purpose USB port × 1 and DVD drive
Ambient Condition	Scanner Unit: -25°C to +55°C (Storage: -25°C to +70°C)
- Operating Temperature	Other Unit: -15°C to +55°C
Ambient Condition	+40°C, 93%
- Relative Humidity	
Ambient Condition	2 to 13.2Hz: Amplitude ±1mm ±10%
- Vibration	13.2 to 100Hz: Acceleration 7m/s ²
Power Supply Input	100 to 115VAC, 50/60Hz 1φ 220 to 240VAC, 50/60Hz 1φ 24VDC
Power Consumption	Rating: Approx. 220VA (DC:72W at AC power outage)
Power Supply Voltage Fluctuation	AC input: ±10% DC input: +30%, -10%
Processing Unit	
Central Control Unit	NDC-1590E/AE
Power Supply Unit	NBD-913
Trackball Operation Unit	NCE-5605
Display	
Display	NWZ-207 / NWZ-214
Option Unit	
Keyboard Operation Unit	NCE-5625
Operation Unit Desktop Frame Rack	CWB-1596
Large tray	CWB-1593
Junction Box	NQE-1143
Sensor LAN Switch Unit	NQA-2443/A
19inch Desktop Frame Rack	CWB-1594 / CWB-1659
19inch Display Unit Mount Kit	CWA-245
Buzzer unit	CGC-25
Safe Distance For Standard Compass	
Display unit	2.4m

22.3 Display Unit

FUNCTIONAL SPECIFICATION	
View	
Scale	1:1,000–1:40,000,000 (19 inch) 1:1,000–1:20,000,000 (26 inch)
Range	0.125, 0.25, 0.5, 0.75, 1.5, 3, 6, 12, 24, 48, 96NM
Motion mode	TM (True Motion) display/(RM (Relative Motion) display
Bearing display mode	Relative motion mode: North UP/Course UP/Head UP/Waypoint UP True motion mode: North UP/Course UP/Head up/Waypoint UP
View mode	Zoom area selection Fix View Multi View Chart drag Off-center Chart original scale display
Navigational tools	
Bearing Scale	360° in 1° step
Heading Line Indication	Yes
Range Rings	0.025, 0.05, 0.1, 0.25, 0.5, 1, 2, 4, 8, 16 NM
Variable Range Marker (VRM)	2
VRM range display	0.000 to 999.9NM, 4-digit display
Electronic Bearing Line (EBL)	2 (center/independent)
EBL bearing display	0.000 to 359.9°, 4-digit display
Trackball Cursor	Yes (range, true/relative bearing, TTG, ETA display)
Parallel Index Line (PI)	Yes (All/Individual/Track/Equiangular)
Sea chart functions	
Chart Display Function	S-57 Ed3.0/3.1 S-63 C-Map Ed3.0 Professional/Professoanl+ *1 C-Map ENC *1 Jeppesen PRIMAR ECDIS Service *1 ARCS
Chart Addition Function	AVCS Pre-install AIO C-Map Dynamic License *1
Update	Manual or semi-automatic
Course planning functions	
Course preparation	Table editing Graphic editing

*1 eToken (Option) is required to use C-map.

Course editing	Waypoint addition, deletion, or editing Alternative course preparation Course copying Inter-course coupling
Safety check	Present
Number of course displays	Maximum 4 types
Sailing monitoring functions	
Own ship	Monitoring by positioning device Monitoring by duplexed positioning device Time stamp display Anchor drag monitoring Own ship course trace back display
Ship course monitoring	Monitoring of deep line crossing such as safety, etc. Monitoring for point water depth Monitoring of obstacles, approaching sailing prohibited region (S-57/S-63/C-Map) Ship course break away monitoring Next WP arrival monitoring Course deviation monitoring
Other ship monitoring	Monitoring by TT display (200 targets max.) Monitoring by AIS display (500 targets max.)
User map	
Number of displayed points	100,000 points (mark, lines)
Export	Possible (USB flash memory)
Other functions	
Data display function	Conning data block display
Self diagnosis function	Present
Remote maintenance function	Present
Playback	Data for playback (3 months max.)
Logbook function	Sailing journal recording data (3 months max.)
Receivable signals (i)	
Ship heading	THS > HDT (over 40Hz)
Course	GGA > RMC > RMA > GNS > GLL
Geodetic positioning system	DTM
Date information	ZDA
COG/SOG	RMC > RMA > VTG
Ship speed through water	VBW > VHW
Turning speed	ROT
Water depth	DPT > DBS > DBK > DBT
Wind direction/wind speed	MWV > MWD
Air temperature	MTA > MDA

Water temperature	MTW > MDA
Atmospheric pressure	MMB > MDA
Humidity	MHU > MDA
AIS	VDM, VDO
TT data	TTM, TLL, TTD, TLB
AIS target data	TTM, TLL, TTD
Alert	ACN, HBT
NAVTEX	NRX or JRC format
Azimuth/distance to the destination	RMB > BWC > BWR (Plotter option)
Water current	CUR
Transmittable signals	
Own ship data	OSD
Watch Timer Reset	EVE*2
TT data	TTM, TLL, TTD, TLB
Remote maintenance data	JRC format
Alert	ALC, ALF, ARC, HBT
Route information	ECDIS information notification (PJRC, EIF00/PJRC, EIS00/WPL)
Autopilot information	ECDIS information notification (PJRC, EIF00)
NAVTEX	NRM
Azimuth/distance to the destination	RMB, BWC
Navigation Data	DBK, DPT, DTM, GGA, GLL, HDG, HDT, MDA, MWV, NSR, POS, RMB, RMC, ROT, RSA, THS, VBW, VDR, VTG, VWR, VWT, XDR, ZDA, HBT, BWC, RTE, WPL, HSC, OSD, RSD, XTE, ZTG
Visual range	
Visual range	1.05m from the center of display

- i. The measuring precision of the speed sensor complies with IMO Resolution MSC.96(72).
The measuring precision of the GPS sensor complies with IMO Resolution MSC.112(73).

*2 When the movement amount of the cursor exceeds the set value of Trackball Threshold, a message is output at the interval set to Reset Interval. The value is set at installation.

22.4 Central Control Unit

GENERAL SPECIFICATION	NDC-1590E/AE: Central Control Unit
CPU	Intel Core i5 2515E 2.5GHz (NDC-1590E) / CPU Intel Core i3 6100E 2.7GHz (NDC-1590AE)
Main Memory	2GB (DDR3, NDC-1590E) / 4GB (DDR4, NDC-1590AE)
JRC ASIC	Yes
Mechanical	
Dimension	Width 400 x Depth 240 x Height 125 (mm)
Mass	5.6kg
FAN	1
Environment	
Operational Temperature	-15°C to +55°C
Operational Humidity	40°C RH 93%
Vibration	Sweep 2 Hz to 13.2 Hz at ± 1 mm, 13.2Hz to 100Hz at 7m/s ² and for 2h on each resonance, otherwise 2h at 30Hz in all three axes
EMC	IEC60945-Ed4.0
Ingress Protection Rating	IP20
Interfaces	
DVI-D	1
VGA	1 (Slave output as DVI-D)
IEC61162-1	2 input (GPS and LOG)
IEC61162-2	2 input (AIS and THD)
IEC61162-450	2 (IEEE802.3u/IEEE802.3ab compliance (100BASE-TX/1000BASE-T))
Dry Contact Output	2 (Power Fail and Watch Timer Reset)
Normally Close	Power Fail (32V 0.8A MAX)
Normally Open	Watch Timer Reset (32V 0.8A MAX)
Operation Unit	1 (5m max)
Extended Operation Unit	1 (up to 30m)
USB I/F	3 (1 for MNU, Others are general purpose)
RADAR I/F	1 input for scanner unit, 1 output for other equipment
Power	Connecting with NBD-913

22.5 Power Supply Unit

GENERAL SPECIFICATION	NBD-913: Power Supply Unit
AC Input	
Voltage	100 to 115VAC, 50/60Hz 1 ϕ 220 to 240VAC, 50/60Hz 1 ϕ
Voltage Range	85 to 264VAC
Overvoltage Protection	295VAC \pm 2V
Input Current	Max 6.8A(100VAC) / 3.4A(220VAC)
Over current Protection	YES
DC Input	
Voltage	24VDC
Voltage Range	21.6 to 31.2VDC
Overvoltage Protection	42V
Input Current	Max 16A
Over current Protection	YES
Rated Output	
Output 1	12.0V \pm 0.24V 2A
Output 2A (for CCU)	24.0V \pm 0.48V 4A
Output 2B (for MNU)	24.0V \pm 0.48V 6A
Output 3 (for TXRX)	48.0V \pm 0.96V 4A
Mechanical	
Dimension	Width 400 x Depth 240 x Height 85 (mm)
Mass	4.2kg
FAN	2
Environment	
Operational Temperature	-15 $^{\circ}$ C to +55 $^{\circ}$ C
Operational Humidity	40 $^{\circ}$ C RH 93%
Vibration	Sweep 2 Hz to 13.2 Hz at \pm 1 mm, 13.2 Hz to 100 Hz at 7m/s ² and for 2h on each resonance, otherwise 2h at 30Hz in all three axes
EMC	IEC60945-Ed4.0
Ingress Protection Rating	IP20

22.6 Trackball Operation Unit

GENERAL SPECIFICATION	NCE-5605: Trackball Operation Unit
Pointing Device	2inch Trackball
Click Button	2-buttons (Left and Right)
USB I/F	1
Speaker	1
Keys	SILENCE/ALERT ACK/ZOOM IN/ZOOM OUT
Knob	Multi Function Knob
Cable Length	Up to 5 m (Up to 30m when using the extended option)
Mechanical	
Dimension	Width 130 x Depth 210 x Height 77 (mm)
Mass	1.3kg
Environment	
Operational Temperature	-15°C to +55°C
Operational Humidity	40°C RH 93%
Vibration	Sweep 2 Hz to 13.2Hz at ± 1 mm, 13.2 Hz to 100 Hz at 7m/s ² and for 2h on each resonance, otherwise 2h at 30Hz in all three axes
EMC	IEC60945-Ed4.0
Ingress Protection Rating	Front : IP22

22.7 19inch Display (NWZ-207)

GENERAL SPECIFICATION	NWZ-207: Display
Screen Size	19inch
Aspect Ratio	5:4
Full Resolution	1280 × 1024
Supported format	1280 × 1024, 1280 × 960, 1024 × 768, 800 × 600, 640 × 480, 720 × 400
Dot Pitch	0.294 mm
Viewing Area	376.32 mm × 301.06 mm
Display Colors	16.77 million colors
Contrast Ratio	2000:1
Viewing Angles (H / V)	178°/178°
Back Light	LED
Brightness	500cd/m ² Type
Digital Scanning Frequency (H / V)	Horizon 30 kHz to 80 kHz Vertical 56 Hz to 75 Hz
DVI-D input	1
VGA input	1
VGA output	N/A
USB Flash Memory	1
Power	21.6 to 31.2VDC
Overvoltage Protection	N/A
DC Reverse Connection Protection	Self Return Type
Cables	Up to 5m
Glass Bonding	Standard
Mechanical	
Dimension	Width 429 x Depth 76 x Height 382 (mm)
Mass	6.0kg
Fan	1
Glass	Tempered Glass + AR Coating
Environment	
Operational Temperature	-15°C to +55°C
Operational Humidity	40°C RH 93%
Vibration	Sweep 2 Hz to 13.2 Hz at ± 1 mm, 13.2 Hz to 100 Hz at 7m/s ² and for 2h on each resonance, otherwise 2h at 30 Hz in all three axes
EMS	IEC60945-Ed4.0
Ingress Protection Rating	Front:IP65 Back:IP22

22.8 19inch Display (NWZ-214)

GENERAL SPECIFICATION	NWZ-214 : Display
Screen Size	19inch
Aspect Ratio	5:4
Full Resolution	1280×1024
Supported format	1280×1024, 1280×960, 1024×768, 800×600, 640×480, 720×400
Dot Pitch	0.294mm
Viewing Area	376.32mm × 301.06mm
Display Colours	16.77 million colours
Contrast Ratio	2000:1
Viewing Angles (H / V)	178°/ 178°
Back Light	LED
Brightness	1000cd/m ² Type
Digital Scanning Frequency (H / V)	Horizon 30kHz to 80kHz Vertical 56Hz to 75Hz
DVI-D input	1
VGA input	1
VGA output	N/A
USB I/F	N/A
Power	21.6 to 31.2VDC
Overvoltage Protection	N/A
DC Reverse Connection Protection	Self Return Type
Cables	Up to 5m
Glass Bonding	Standard
Mechanical	
Dimension	Width 429 × Depth 76 × Height 382 (mm)
Mass	4.6kg
Fan	1
Glass	Tempered Glass + AR Coating
Environment	
Operational Temperature	-15°C to +55°C
Operational Humidity	40°C RH 93%
Vibration	Sweep 2Hz to 13.2Hz at ± 1mm, 13.2Hz to 100Hz at 7m/s ² and for 2h on each resonance, otherwise 2h at 30Hz in all three axes
EMC	IEC60945-Ed4.0
Ingress Protection Rating	Front:IP65 Back:IP22

22.9 26inch Display

GENERAL SPECIFICATION	NWZ-208: Display
Screen Size	26inch
Aspect Ratio	16:10
Full Resolution	1920 × 1200RB
Supported format	1920 × 1200RB, 1680 × 1050, 1680 × 1050RB, 1600 × 1200, 1600 × 1200RB, 1280 × 1024, 1024 × 768, 800 × 600, 640 × 480
Dot Pitch	0.2865 mm
Viewing Area	550.08 mm × 343.8 mm
Display Colors	16.77 million colors
Contrast Ratio	1500:1
Viewing Angles (H / V)	176°/176°
Back Light	LED
Brightness	400cd/m ² Type
Digital Scanning Frequency (H / V)	Horizon 30 kHz to 75 kHz Vertical 56 Hz to 75 Hz
DVI-D input	1
VGA input	1
VGA output	1
USB I/F	1
Power	21.6 to 31.2VDC 85 to 265VAC 50/60Hz
Overvoltage Protection	N/A
DC Reverse Connection Protection	Self-Return Type
Cables	Up to 5 m
Glass Bonding	Optional
Mechanical	
Dimension	Width 624 x Depth 85 x Height 456 (mm)
Mass	16kg
Fan	2
Glass	Tempered Glass + AR Coating
Environment	
Operational Temperature	-15°C to +55°C
Operational Humidity	40°C RH 93%
Vibration	Sweep 2 Hz to 13.2Hz at ± 1 mm, 13.2 Hz to 100 Hz at 7m/s ² and for 2h on each resonance, otherwise 2h at 30Hz in all three axes
EMC	IEC60945-Ed4.0
Ingress Protection Rating	Front: IP65 Back: IP22

22.10 Keyboard OPU

GENERAL SPECIFICATION	NCE-5625: Keyboard Operation Unit
PC Keyboard	
Layout	QWERTY
Pitch	15mm
Stroke	2mm
Dedicated Keys	
Keys	HOME, TX/STBY, PI, DISP OFF, AZ, PANEL, DAY/NIGHT, MOB, USER1, USER2
Knobs	EBL, VRM, SEA, RAIN, GAIN
Mechanical	
Dimension	Width 270 x Depth 210 x Height 30 (mm)
Mass	0.8kg
Environment	
Operational Temperature	-15°C to +55°C
Operational Humidity	40°C RH 93%
Vibration	Sweep 2 Hz to 13.2 Hz at ± 1 mm, 13.2 Hz to 100 Hz at 7m/s ² and for 2h on each resonance, otherwise 2h at 30 Hz in all three axes
EMC	IEC60945-Ed4.0
Ingress Protection Rating	Front : IP22

22.11 26inch Display Unit Mount Kit

Note

JAN-9201S/7201S can't use 26inch Display Unit Mount Kit.

GENERAL SPECIFICATION	CWA-246: 26inch Display Unit Mount Kit
Mechanical	
Dimension	Width 680 x Depth 718 x Height 1100 (mm)
Mass	APPROX. 65kg
Environment	
Operational Temperature	-15°C to +55°C
Operational Humidity	40°C RH 93%
Vibration	Sweep 2 Hz to 13.2 Hz at ± 1 mm, 13.2 Hz to 100 Hz at 7m/s ² and for 2h on each resonance, otherwise 2h at 30Hz in all three axes
EMC	IEC60945-Ed4.0
Ingress Protection Rating	Front : IP22

22.12 19inch Display Unit Mount Kit

Note

JAN-9201S/7201S can't use 19inch Display Unit Mount Kit.

GENERAL SPECIFICATION	CWA-245: 19inch DISPLAY UNIT MOUNT KIT
Structure	
Dimension	Width 580 × Depth 718 × Height 1100 (mm)
Mass	Approx. 55kg
Environment	
Operational Temperature	-15°C to +55°C
Operational Humidity	40°C RH 93%
Vibration	Sweep 2 Hz to 13.2 Hz at ± 1 mm, 13.2 Hz to 100 Hz at 7m/s ² and for 2h on each resonance, otherwise 2h at 30Hz in all three axes
EMC	IEC60945-Ed4.0
Ingress Protection Rating	Front: IP22

22.13 Sensor LAN switch unit

GENERAL SPECIFICATION		NQA-2443: Sensor LAN switch unit
Technology		
Standards		IEEE802.3, 802.3u, 802.3x
Processing type		Store and Forward, with IEEE802.3 full duplex, back pressure flow control
Forward and Filtering Rate		148810 pps
Latency		Less than 5us
Interface		
Number of ports		16
RJ45		10/100BASE-T(X) auto negotiation speed, F/H duplex mode, and auto MDI/MDI-X connection
LED		Power, Fault, Speed
Power		
Input Voltage		12 to 48 VDC
Input Current		0.34A max
Over Current Protection		1.6A
Reverse Polarity Protection		Yes
Mechanical		
Dimension		Width 75.0 x Depth 105 x Height 179 (mm)
Mass		1.5kg
Environment		
Operational Temperature		-15°C to +55°C
Operational Humidity		40°C RH 93%
Vibration		Sweep 2 Hz to 13.2 Hz at ± 1 mm, 13.2 Hz to 100 Hz at 7m/s ² and for 2h on each resonance, otherwise 2h at 30 Hz in all three axes
EMC		IEC60945-Ed4.0

GENERAL SPECIFICATION		NQA-2443A: Sensor LAN switch unit
Technology		
Standards	IEEE802.3, 802.3u, 802.3x, 802.3ab	
Processing type	Store and Forward, with IEEE802.3 full duplex,	
Maximum throughput	14880 pps / port (10Mbps, 64byte pkt, uni-cast)	
	148810 pps / port (100Mbps, 64byte pkt, uni-cast)	
	1488100 pps / port (1000Mbps, 64byte pkt, uni-cast)	
*Wire speed : 100%		
Interface		
Number of ports	16	
RJ45	10/100/1000BASE-T(X) auto negotiation speed, F/H duplex mode, and auto MDI/MDI-X connection	
LED	PWR, UVP/OVP, RVP, LOOP, LINK/ACT	
Power		
Input Voltage	18 to 36 VDC	
Maximum Power Consumption	13.2 W and under	
Reverse Polarity Protection	Yes	
Mechanical		
Dimension	Width 75.0 x Depth 105 x Height 179 (mm)	
Mass	0.8kg	
Environment		
Operational Temperature	-25°C to +70°C	
Operational Humidity	40°C RH 93%	
Vibration	Sweep 2 Hz to 13.2 Hz at ± 1 mm, 13.2 Hz to 100 Hz at 7m/s ²	
	and for 2h on each resonance, otherwise 2h at 30 Hz in all three axes	
EMC	IEC60945-Ed4.0	

22.14 Junction Box

GENERAL SPECIFICATION		NQE-1143: Junction Box
Mechanical		
Dimension	Width 400 x Depth 86 x Height 261.5 (mm)	
Mass	3.8kg	
Environment		
Operational Temperature	-15°C to +55°C	
Operational Humidity	40°C RH 93%	
Vibration	Sweep 2Hz to 13.2Hz at ± 1mm, 13.2Hz to 100Hz at 7m/s ² and for 2h on each resonance, otherwise 2h at 30Hz in all three axes	
EMC	IEC60945-Ed4.0	
Ingress Protection Rating	Front : IP20	
Power		
Power	21.6 to 31.2 VDC	
Input Voltage	48W MAX	
Power Consumption	3A × 2, 15A × 1 Mini Blade Fuse	
Over Current Protection	Yes	
FUNCTIONAL SPECIFICATION		CMH-2370: Serial LAN Interface Circuit
Interface		
IEC61162-1	8 input / 8 output	
IEC61162-2	2 input / 2 output	
IEC61162-450	1 (100BASE-TX)	
Dry Contact Output (N.C/N.O selectable)	8 (32V, 0.8A sink MAX)	
Dry Contact Input	8 (5V, 50mA source MAX)	
Ingress Protection Rating	Front : IP20	
FUNCTIONAL SPECIFICATION		CMJ-554: Gyro Interface Circuit
GYRO		
STEP	22 to 70 VDC	
SYNC	24 to 115VAC, 50/60/400Hz	
RATIO	36×/90×/180×/360×	
OUTPUT	THS (50Hz)	
LOG		
PULSE	Dry contact: 30V(max), 50 mA(max) Voltage signal: 0-50V (threshold level is 2V)	
RATIO	100/200/400/800 [P/NM]	
OUTPUT	VBW (1Hz), VLW (0.1Hz)	
FUNCTIONAL SPECIFICATION		CMJ-556: Analog Option Circuit
Interface		
Isolated Input	4	
Input Signal Range	-10 to 10 VDC or 4 to 20 mA	
FUNCTIONAL SPECIFICATION		CQD-2554: Connection Board (for Gyro Interface Circuit)
Interface		

Appendix A Alert, Maintenance INFO and Permanent information

A.1 Alert

When an alert occurs, alert information is displayed in the alert notification area.

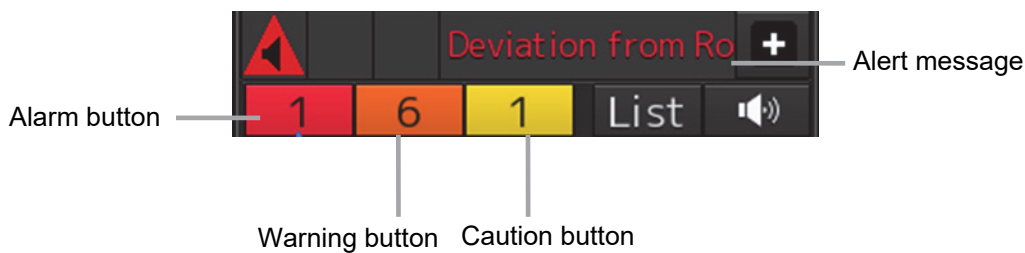

The numbers displayed in the buttons indicate the number of such alerts that have occurred.

Memo

The alert button of a category that has not occurred will not be displayed.

The display colors of alert messages are defined as follows according to the type and seriousness of alerts.

Alert Type	Alert Class (Seriousness)	Display Color	Alert Display Status	Alert Sound
Alarms (An alert indicating a state asking sailors to pay immediate attention and take immediate action.)	Alarms	Red	Before alarm acknowledgement: Blinking After alarm acknowledgement: Lighting	3 short audible signals (repetitive)
Warnings (An alert indicating that the state has changed, which although is not immediately dangerous, but may become so in the near future if no action is taken. Warnings are alerts displayed for preventing possible future hazardous states.)	Warnings	Orange	Before warning acknowledgement: Blinking After warning acknowledgement: Lighting	2 short audible signals (repetitive)
Cautions (Although these are neither alarms nor warnings, these alerts indicate that it is necessary to pay more than normal attention to cautions, statuses, or to the supplied information.)	Cautions	Yellow	Lighting	No sound
No Alarm	-	Green	-	-

The list of alerts is shown below.

Types of alert categories is shown below.

Category A: Alert about grounding, collision

Category B: All alerts except category A

A.1.1 Priority: Alarms

Cause	Conditions to raise	Conditions to rectify	Detail	Category	Required standard
Alarm Symbol	The ship is near a user-defined Alarm Symbol.	The ship moved away from user-defined Alarm Symbol.	Check ahead on the DISP	A	IEC 61174
Crossing Safety Contour	The ship is near a safety contour.	The ship moved away from safety contour.	Check ahead on the DISP	A	IEC 61174
Deviation From Route	The ship deviated from the track beyond a preset cross-track limit.	The ship is deviated from the track within a preset cross-track limit.	Check the DIST from Route on the DISP	A	IEC 61174
Outside Anchor Watch Area	A Outside Anchor Watch Area warning was not acknowledged for 120 seconds.	Own ship entered the dragging anchor monitoring area.	Check position on the DISP	A	IEC 61174

A.1.2 Priority: Warnings

Cause	Conditions to raise	Conditions to rectify	Detail	Category	Required standard
AC Power Failure	The AC input voltage is 75V or less	The AC input voltage is more than 75V	The AC input voltage is 75V or less	B	-
AIS Maximum Capacity	The AIS target count exceeded the maximum target display count.	The AIS target count is less than the maximum target display count.	Unable to add new AIS target	A	IEC 61174
Anchorage Area	The ship is near an Anchorage Area. Warning or caution as selected by user. Default Setting is Caution.	The ship moved away from Anchorage Area.	Check ahead on the DISP	A	IEC 61174
Anchorage Prohibited	The ship is near an Anchorage Prohibited Area. Warning or caution as selected by user. Default Setting is Caution.	The ship moved away from Anchorage Prohibited.	Check ahead on the DISP	A	IEC 61174
Archipelagic Sea Lane	The ship is near an Archipelagic Sea Lane. Warning or caution as selected by user. Default Setting is Caution.	The ship moved away from Archipelagic Sea Lane.	Check ahead on the DISP	A	IEC 61174
ARCS Security failed	Chart license for ARCS is not installed. Or the ARCS chart is not the latest version.	Chart license for ARCS is installed. Or the latest ARCS chart is installed.	-	B	-
Arrived at WOL	Arrived at WOL.	Warning is acknowledged.	Check on the DISP.	A	IEC 61174
Arrived at WPT	Arrived at WPT.	Warning is acknowledged.	Check on the DISP.	A	IEC 61174
Buoy/Light	The ship is near a Buoy/Light.	The ship moved away from Buoy/Light.	Check ahead on the DISP	A	IEC 61174
Cable Area	The ship is near a Cable Area. Warning or caution as selected by user. Default Setting is Caution.	The ship moved away from Cable Area.	Check ahead on the DISP	A	IEC 61174

Cause	Conditions to raise	Conditions to rectify	Detail	Category	Required standard
Canal	The ship is near a Canal. Warning or caution as selected by user. Default Setting is Caution.	The ship moved away from Canal.	Check ahead on the DISP	A	IEC 61174
Cargo Transshipment Area	The ship is near a Cargo Transshipment Area. Warning or caution as selected by user. Default Setting is Caution.	The ship moved away from Cargo Transshipment Area.	Check ahead on the DISP	A	IEC 61174
Caution Area	The ship is near a Caution Area. Warning or caution as selected by user. Default Setting is Caution.	The ship moved away from Caution Area.	Check ahead on the DISP	A	IEC 61174
Chart Shift	The chart was manually shifted on the ARCS chart.	Chart offset is cleared. Or Chart display is switched to S57 or C-MAP chart.	-	B	-
Chart Shift to WGS84	ARCS chart with offset information to match WGS84 was displayed.	Chart display is switched to S57 or C-MAP chart.	ARCS chart is shifted to WGS84	B	-
Dangerous Symbol	The ship is near a Dangerous Symbol.	The ship moved away from Dangerous Symbol.	Check ahead on the DISP	A	IEC 61174
Deeper Water Route	The ship is navigating in a deeper water route. Warning or caution as selected by user. Default Setting is Caution.	The ship exits a deeper water route.	Check ahead on the DISP	A	IEC 61174
Delivery Failed to VDR	Equipment can't send the image to VDR for 1 minute.	Equipment can send the image to VDR for more than 1 minute.	Can't send image to VDR	B	IEC 61174

Cause	Conditions to raise	Conditions to rectify	Detail	Category	Required standard
Depth Area	The ship is navigating in a water shallower than safety waters.	The ship exits a water shallower than safety waters.	Check ahead on the DISP	A	IEC 61174
Dredge Area	The ship is near a Dredge Area.	The ship moved away from Dredge Area.	Check ahead on the DISP	A	IEC 61174
Dumping Ground	The ship is navigating in a dumping ground. Warning or caution as selected by user. Default Setting is Caution.	The ship exits a dumping ground.	Check ahead on the DISP	A	IEC 61174
Fairway	The ship is near a Fairway. Warning or caution as selected by user. Default Setting is Caution.	The ship moved away from Fairway.	Check ahead on the DISP	A	IEC 61174
Fishing Ground	The ship is near a Fishing Ground. Warning or caution as selected by user. Default Setting is Caution.	The ship moved away from Fishing Ground	Check ahead on the DISP	A	IEC 61174
Fishing Prohibited	The ship is near a Fishing Ground. Warning or caution as selected by user. Default Setting is Caution.	The ship moved away from Fishing Prohibited	Check ahead on the DISP	A	IEC 61174
Ice Area	The ship is near a Crossing Oce Area.	The ship moved away from Oce Area.	Check ahead on the DISP	A	IEC 61174
Incineration Area	The ship is near an Incineration Area. Warning or caution as selected by user. Default Setting is Caution.	The ship moved away from Incineration Area	Check ahead on the DISP	A	IEC 61174
Inshore Traffic Zone	The ship is near an Inshore Traffic Zone. Warning or caution as selected by user. Default Setting is Caution.	The ship moved away from Inshore Traffic Zone	Check ahead on the DISP	A	IEC 61174
Lost COG/SOG	COG/SOG data from primary sensor is lost.	COG/SOG data from primary sensor can be received.	-	B	IEC 61174

Cause	Conditions to raise	Conditions to rectify	Detail	Category	Required standard
Lost HDG	Heading data from primary sensor is lost.	Heading data from primary sensor can be received.	-	B	IEC 61174
Lost POSN	Position data from primary sensor is lost.	Position data from primary sensor can be received.	-	B	IEC 61174
Marine Farm/Aquaculture	The ship is near a Marine Farm/Aquaculture. Warning or caution as selected by user. Default Setting is Caution.	The ship moved away from Marine Farm/Aquaculture.	Check ahead on the DISP	A	IEC 61174
Military Practice Area	The ship is near a Military Practice Area. Warning or caution as selected by user. Default Setting is Caution.	The ship moved away from Military Practice Area.	Check ahead on the DISP	A	IEC 61174
NON-WGS84	DATUM of POSN is not WGS84.	DATUM of POSN is WGS84.	DATUM of POSN is not WGS84	B	IEC 61174
Obstruction	The ship is near an Obstruction.	The ship moved away from Obstruction.	Check ahead on the DISP	A	IEC 61174
Offshore Production Area	The ship is near an Offshore Production Area. Warning or caution as selected by user. Default Setting is Caution.	The ship moved away from Offshore Production Area.	Check ahead on the DISP	A	IEC 61174
Outside Anchor Watch Area	Own ship exited from the dragging anchor monitoring area. If Outside Anchor Watch Area warning is not acknowledged for 2 minutes, the warning escalates to Outside Anchor Watch Area alarm.	Own ship entered the dragging anchor monitoring area.	Check position on the DISP	A	IEC 61174
Over 85 Degrees	Own ship position is 85 degrees or more.	Own ship position is less than 85 degrees.	System performance is reduced.	A	IEC 61174
Pipeline Area	The ship is near a Pipeline Area.	The ship moved away from Pipeline Area.	Check ahead on the DISP	A	IEC 61174

Cause	Conditions to raise	Conditions to rectify	Detail	Category	Required standard
Recommended Traffic Lane	The ship is near a Recommended Traffic Lane. Warning or caution as selected by user. Default Setting is Caution.	The ship moved away from Recommended Traffic Lane.	Check ahead on the DISP	A	IEC 61174
Restricted Area	The ship is near a Restricted Area. Warning or caution as selected by user. Default Setting is Caution.	The ship moved away from Restricted Area.	Check ahead on the DISP	A	IEC 61174
Seaplane Landing Area	The ship is near a Seaplane Landing Area. Warning or caution as selected by user. Default Setting is Caution.	The ship moved away from Seaplane Landing Area.	Check ahead on the DISP	A	IEC 61174
Sensitive Sea Area	The ship is near a Sensitive Sea Area a. Warning or caution as selected by user. Default Setting is Caution.	The ship moved away from Sensitive Sea Area.	Check ahead on the DISP	A	IEC 61174
Specially Protected Area	The ship is near a Specially Protected Area. Warning or caution as selected by user. Default Setting is Caution.	The ship moved away from Specially Protected Area.	Check ahead on the DISP	A	IEC 61174
Spoil Ground	The ship is near a Spoil Ground. Warning or caution as selected by user. Default Setting is Caution.	The ship moved away from Spoil Ground.	Check ahead on the DISP	A	IEC 61174
Submarine Transit Area	The ship is near a Submarine Transit Area. Warning or caution as selected by user. Default Setting is Caution.	The ship moved away from Transit Area.	Check ahead on the DISP	A	IEC 61174
System Failure	CCU or PSU or OPU or GIF or RIF Failure is occurred.	CCU and PSU and OPU and GIF and RIF Failure	-	B	IEC 61174

Cause	Conditions to raise	Conditions to rectify	Detail	Category	Required standard
Traffic Crossing	The ship is near a Traffic Crossing. Warning or caution as selected by user. Default Setting is Caution.	The ship moved away from Traffic Crossing.	Check ahead on the DISP	A	IEC 61174
Traffic Precautionary	The ship is near a Traffic Precautionary. Warning or caution as selected by user. Default Setting is Caution.	The ship moved away from Traffic Precautionary.	Check ahead on the DISP	A	IEC 61174
Traffic Roundabout	The ship is near a Traffic Roundabout. Warning or caution as selected by user. Default Setting is Caution.	The ship moved away from Traffic Roundabout.	Check ahead on the DISP	A	IEC 61174
Traffic Separation Zone	The ship is near a Traffic Separation Zone. Warning or caution as selected by user. Default Setting is Caution.	The ship moved away from Traffic Separation Zone.	Check ahead on the DISP	A	IEC 61174
Two Way Traffic	The ship is near a Two Way Traffic. Warning or caution as selected by user. Default Setting is Caution.	The ship moved away from Two Way Traffic.	Check ahead on the DISP	A	IEC 61174
Under Rater Rock	The ship is near a Under Rater Rock. Warning or caution as selected by user. Default Setting is Caution.	The ship moved away from Under Rater Rock.	Check ahead on the DISP	A	IEC 61174
Unexpected Data from VDR	Unexpected data was received from VDR.	No unexpected data is received from the VDR.	Unable to connect to VDR	B	IEC 61174
Warning Symbol	The ship is near a Warning Symbol.	The ship moved away from Warning Symbol.	Check ahead on the DISP	A	IEC 61174
Wreck	The ship is near a Wreck.	The ship moved away from Wreck.	Check ahead on the DISP	A	IEC 61174

A.1.3 Priority: Cautions

Cause	Conditions to raise	Conditions to rectify	Detail	Category	Required standard
AIS 95% Capacity	The AIS target count exceeded 95% of the maximum target display count.	The AIS target count is less than 95% of the maximum target display count.	A few more AIS targets can be added	B	IEC 61174
AIS ACT 95% Capacity	The AIS activation target count exceeded 95% of the maximum target display count.	The AIS activation target count is less than 95% of the maximum target display count.	A few more AIS ACT targets can be added	B	IEC 61174
Anchorage Area	The ship is near an Anchorage Area. Warning or caution as selected by user. Default Setting is Caution.	The ship moved away from Anchorage Area.	Check ahead on the DISP	B	IEC 61174
Anchorage Prohibited	The ship is near an Anchorage Prohibited. Warning or caution as selected by user. Default Setting is Caution.	The ship moved away from Anchorage Prohibited.	Check ahead on the DISP	B	IEC 61174
Archipelagic Sea Lane	The ship is near an Archipelagic Sea Lane. Warning or caution as selected by user. Default Setting is Caution.	The ship moved away from Archipelagic Sea Lane.	Check ahead on the DISP	B	IEC 61174
AtoN	The ship is near an AtoN.	The ship moved away from AtoN.	Check ahead on the DISP	B	IEC 61174
Cable Area	The ship is near a Cable Area. Warning or caution as selected by user. Default Setting is Caution.	The ship moved away from Cable Area.	Check ahead on the DISP	B	IEC 61174
Canal	The ship is near a Canal. Warning or caution as selected by user. Default Setting is Caution.	The ship moved away from Canal.	Check ahead on the DISP	B	IEC 61174

Cause	Conditions to raise	Conditions to rectify	Detail	Category	Required standard
Cargo Transshipment Area	The ship is near a Cargo Transshipment Area. Warning or caution as selected by user. Default Setting is Caution.	The ship moved away from Cargo Transshipment Area.	Check ahead on the DISP	B	IEC 61174
Caution Area	The ship is near a Caution Area. Warning or caution as selected by user. Default Setting is Caution.	The ship moved away from Caution Area.	Check ahead on the DISP	B	IEC 61174
Caution Symbol	The ship is near a Caution Symbol.	The ship moved away from Caution Symbol.	Check ahead on the DISP	B	IEC 61174
Chart license will expire soon (SSE 20)	Chart license will expire within 30 days.	Chart license is renewed with a license valid for 30 days or more.	Renew chart license within 30 days	B	-
DC Power Failure	The DC input voltage is 18V or less	The DC input voltage is more than 18V	The DC input voltage is 18V or less	B	-
Deeper Water Route	The ship is near a Deeper Water Route. Warning or caution as selected by user. Default Setting is Caution.	The ship moved away from Deeper Water Route.	Check ahead on the DISP	B	IEC 61174
Dumping Ground	The ship is near a Dumping Ground. Warning or caution as selected by user. Default Setting is Caution.	The ship moved away from Dumping Ground.	Check ahead on the DISP	B	IEC 61174
ENC Data Are Available	ENC Data are available.	ENC Data are not available.	-	B	-
Fairway	The ship is near a Fairway. Warning or caution as selected by user. Default Setting is Caution.	The ship moved away from Fairway.	Check ahead on the DISP	B	IEC 61174
Fishing Ground	The ship is near a Fishing Ground. Warning or caution as selected by user. Default Setting is Caution.	The ship moved away from Fishing Ground.	Check ahead on the DISP	B	IEC 61174

Cause	Conditions to raise	Conditions to rectify	Detail	Category	Required standard
Fishing Prohibited	The ship is near a Fishing Prohibited. Warning or caution as selected by user. Default Setting is Caution.	The ship moved away from Fishing Prohibited.	Check ahead on the DISP	B	IEC 61174
Incineration Area	The ship is near a Fishing Prohibited. Warning or caution as selected by user. Default Setting is Caution.	The ship moved away from Fishing Prohibited.	Check ahead on the DISP	B	IEC 61174
Inshore Traffic Zone	The ship is near an Inshore Traffic Zone. Warning or caution as selected by user. Default Setting is Caution.	The ship moved away from Inshore Traffic Zone.	Check ahead on the DISP	B	IEC 61174
Lost AIS IF	AIS interface is lost.	AIS interface is normal condition.	AIS target cannot be displayed	B	IEC 61174
Lost AP	Autopilot interface is lost.	Autopilot interface is normal condition.	Can't control AP	B	IEC 61174
Lost COG/SOG	COG/SOG data from primary sensor is lost.	COG/SOG data from primary sensor can be received.	-	B	-
Lost HDG	Heading data from primary sensor is lost.	Heading data from primary sensor can be received.	-	B	-
Lost POSN	Position data from primary sensor is lost.	Position data from primary sensor can be received.	-	B	-
Lost RADAR Function	Radar Antenna signal is lost.	Radar Antenna signal can be received.	Lost Radar Antenna signal.	B	IEC 61174
Lost TT1	TT1 data is lost.	TT1 data can be received.	TT1 target cannot be displayed	B	IEC 61174
Lost TT2	TT2 data is lost.	TT2 data can be received.	TT2 target cannot be displayed	B	IEC 61174
Marine Farm/Aquaculture	The ship is near a Marine Farm/Aquaculture. Warning or caution as selected by user. Default Setting is Caution.	The ship moved away from Marine Farm/Aquaculture.	Check ahead on the DISP	B	IEC 61174

Cause	Conditions to raise	Conditions to rectify	Detail	Category	Required standard
Military Practice Area	The ship is near a Military Practice Area. Warning or caution as selected by user. Default Setting is Caution.	The ship moved away from Military Practice Area.	Check ahead on the DISP	B	IEC 61174
Offshore Production Area	The ship is near an Offshore Production Area. Warning or caution as selected by user. Default Setting is Caution.	The ship moved away from Offshore Production Area.	Check ahead on the DISP	B	IEC 61174
Pipeline Area	The ship is near a Pipeline Area. Warning or caution as selected by user. Default Setting is Caution.	The ship moved away from Pipeline Area.	Check ahead on the DISP	B	IEC 61174
POSN(Jump)	Position is jumped beyond a DR position (preset Radius limit).	Position is jumped within a DR position (preset Radius limit).	-	B	-
Recommended Traffic Lane	The ship is near a Recommended Traffic Lane. Warning or caution as selected by user. Default Setting is Caution.	The ship moved away from Recommended Traffic Lane.	Check ahead on the DISP	B	IEC 61174
Restricted Area	The ship is near a Restricted Area. Warning or caution as selected by user. Default Setting is Caution.	The ship moved away from Restricted Area.	Check ahead on the DISP	B	IEC 61174
Seaplane Landing Area	The ship is near a Seaplane Landing Area. Warning or caution as selected by user. Default Setting is Caution.	The ship moved away from Seaplane Landing Area.	Check ahead on the DISP	B	IEC 61174
Selected Fix View	Fix view is selected.	Fix view is not selected.	-	B	-

Cause	Conditions to raise	Conditions to rectify	Detail	Category	Required standard
Sensitive Sea Area	The ship is near a Sensitive Sea Area. Warning or caution as selected by user. Default Setting is Caution.	The ship moved away from Sensitive Sea Area.	Check ahead on the DISP	B	IEC 61174
Specially Protected Area	The ship is near a Specially Protected Area. Warning or caution as selected by user. Default Setting is Caution.	The ship moved away from Specially Protected Area.	Check ahead on the DISP	B	IEC 61174
Spoil Ground	The ship is near a Spoil Ground. Warning or caution as selected by user. Default Setting is Caution.	The ship moved away from Spoil Ground.	Check ahead on the DISP	B	IEC 61174
Spot Sounding	The ship is near a Spot Sounding.	The ship moved away from Spot Sounding.	Check ahead on the DISP	B	IEC 61174
Submarine Transit Area	The ship is near a Submarine Transit Area. Warning or caution as selected by user. Default Setting is Caution.	The ship moved away from Submarine Transit Area.	Check ahead on the DISP	B	IEC 61174
To Be Avoided	The ship is near an Obstacle.	The ship moved away from Obstacle.	Check ahead on the DISP	B	IEC 61174
Traffic Crossing	The ship is near a Traffic Crossing. Warning or caution as selected by user. Default Setting is Caution.	The ship moved away from Traffic Crossing.	Check ahead on the DISP	B	IEC 61174
Traffic Precautionary	The ship is near a Traffic Precautionary. Warning or caution as selected by user. Default Setting is Caution.	The ship moved away from Traffic Precautionary.	Check ahead on the DISP	B	IEC 61174
Traffic Roundabout	The ship is near a Traffic Roundabout. Warning or caution as selected by user. Default Setting is Caution.	The ship moved away from Traffic Roundabout.	Check ahead on the DISP	B	IEC 61174

Cause	Conditions to raise	Conditions to rectify	Detail	Category	Required standard
Traffic Separation Zone	The ship is near a Traffic Separation Zone. Warning or caution as selected by user. Default Setting is Caution.	The ship moved away from Traffic Separation Zone.	Check ahead on the DISP	B	IEC 61174
Two Way Traffic	The ship is near a Two Way Traffic. Warning or caution as selected by user. Default Setting is Caution.	The ship moved away from Two Way Traffic.	Check ahead on the DISP	B	IEC 61174
Vertical Clearance	The ship is near a Vertical Clearance.	The ship moved away from Vertical Clearance.	Check ahead on the DISP	B	IEC 61174

A.1.4 List of Alert escalation

There are unacknowledged alert that escalates as follows.

- Alarm to Back-up Navigator Call

If the alarm is not acknowledged for an extra period, Back-up Navigator Call is transferred to BNWAS.

- Warning to Alarm

If warning is not acknowledged, the warning escalates to alarm.

- Warning to Warning

An unacknowledged warning will be generated repeatedly until it is acknowledged.

The Alerts to escalation are as shown below.

The Alerts to escalation are as shown below.

Cause	Escalation	Time	Explanation
Alarm Symbol alarm	Alarm to Back-up Navigator Call	30s	If the alarm is not acknowledged for an extra period of 30 seconds, Back-up Navigator Call is transferred to BNWAS.
Crossing Safety Contour alarm	Alarm to Back-up Navigator Call	30s	If the alarm is not acknowledged for an extra period of 30 seconds, Back-up Navigator Call is transferred to BNWAS.
Deviation From Route alarm	Alarm to Back-up Navigator Call	30s	If the alarm is not acknowledged for an extra period of 30 seconds, Back-up Navigator Call is transferred to BNWAS.
Outside Anchor Watch Area alarm	Alarm to Back-up Navigator Call	30s	If the alarm is not acknowledged for an extra period of 30 seconds, Back-up Navigator Call is transferred to BNWAS.
Outside Anchor Watch Area warning	Warning to Alarm	120s	If Outside Anchor Watch Area warning is not acknowledged for 2 minutes, the warning escalates to Outside Anchor Watch Area alarm.
Other warning	Warning to Warning	60s (Default)	An unacknowledged warning will be generated repeatedly until it is acknowledged.

A.1.5 List of Alerts with responsibility-transferred state

The responsibility-transferred state is a state for priority reduction. When the equipment managing the alert in the system requests a transfer of responsibility of alert, the requested equipment changes state of the alert to responsibility transferred.

Alerts in responsibility transferred state will not be displayed on the active alert list. Whether to display of the responsibility have been transferred alerts on the active alert list can be switched to ON or OFF in the setting. Refer to 15.8 Setting up Alert Processing.

These alerts with responsibility transferred states are as shown below.

Cause	Priority	Category
Lost POSN	Warning	B
Lost HDG	Warning	B
Lost COG/SOG	Warning	B
Chart Shift	Warning	B
Chart Shift to WGS84	Warning	B
NON-WGS84	Warning	B
ARCS Security failed	Warning	B
Delivery Failed to VDR	Warning	B
Unexpected Data from VDR	Warning	B
System Failure	Warning	B
AC Power Failure	Warning	B

A.1.6 List of Aggregated Alerts

Aggregated Alerts are the ability to display multiple alerts in an apparent single alert.

The apparent alerts are called header alerts and the alerts that are aggregated are called member alerts.

A header alert has the following characteristics:

- 1) Header alerts and that's member alerts has same category and same priority.
- 2) The priority of the header alert is the same as the highest priority among the member alerts.
- 3) Header alerts cannot be acknowledged directory.















Header alerts	Priority	Category	Member alerts
Warning Area/Object	Warning	A	Traffic Separation Zone
			Traffic Crossing
			Traffic Roundabout
			Traffic Precautionary
			Two Way Traffic
			Deeper Water Route
			Recommended Traffic Lane
			Inshore Traffic Zone
			Fairway
			Restricted Area
			Caution Area
			Offshore Production Area
			Military Practice Area
			Seaplane Landing Area
			Submarine Transit Area
			Crossing Ice Area
			Canal
			Fishing Ground
			Fishing Prohibited
			Pipeline Area
			Cable Area
			Anchorage Area
			Anchorage Prohibited
Spoil Ground			
Dumping Ground			
Crossing Dredge Area			
Cargo Transshipment Area			

Header alerts	Priority	Category	Member alerts
			Incineration Area Specially Protected Area Sensitive Sea Area Archipelagic Sea Lane Marine Farm/Aquaculture Depth Area Warning Object Obstruction Under Rater Rock Wreck Buoy/Light Dangerous Symbol
Caution Area/Object	Caution	B	Traffic Separation Zone Traffic Crossing Traffic Roundabout Traffic Precautionary Two Way Traffic Deeper Water Route Recommended Traffic Lane Inshore Traffic Zone Fairway Restricted Area Caution Area Offshore Production Area Military Practice Area Seaplane Landing Area Submarine Transit Area Canal Fishing Ground Fishing Prohibited Pipeline Area Cable Area Anchorage Area Anchorage Prohibited Spoil Ground Dumping Ground Cargo Transshipment Area Incineration Area Specially Protected Area

Header alerts	Priority	Category	Member alerts
			Sensitive Sea Area
			Archipelagic Sea Lane
			Marine Farm/Aquaculture
			Caution Object
			Spot Sounding
			AtoN
			Vertical Clearance
			To Be Avoided

A.1.7 List of Alert Icons

The alert icons displayed in the alert status area are listed below.

No.	Name of alert icon	Functional outline	Alert icon
1	Active – unacknowledged alarm	A flashing red triangle. A symbol of loudspeaker in the middle of the triangle.	
2	Active – silenced alarm	A flashing red triangle. A symbol as in icon number 1 with a prominent diagonal line above it.	
3	Active – acknowledged alarm	A red triangle. An exclamation mark in the middle of the triangle.	
4	Active - responsibility transferred alarm	A red triangle. An arrow pointing towards the right in the middle of the triangle.	
5	Rectified – unacknowledged alarm	A flashing red triangle. A tick mark in the middle of the triangle.	
6	Active - unacknowledged warning	A flashing yellowish orange circle. A symbol of loudspeaker in the middle of the circle.	
7	Active – silenced warning	A flashing yellowish orange circle. A symbol as in icon number 6 with a prominent diagonal line above it.	
8	Active – acknowledged warning	A yellowish orange circle. An exclamation mark in the middle of the circle.	
9	Active - responsibility transferred warning	A yellowish orange circle. An arrow pointing towards the right in the middle of the circle.	
10	Rectified – unacknowledged warning	A flashing yellowish orange circle. A tick mark in the middle of the circle.	
11	Caution	A yellow square. An exclamation mark in the middle of the square.	
a	Aggregation	A plus sign. To be presented together with icons number 1 to 11	
b	Acknowledge not allowed for alarm	A red triangle with a cross in the middle of triangle. To be presented together with icons number 1, 2 and 5.	
c	Acknowledge not allowed for warning	A yellowish orange circle with a cross in the middle of circle. To be presented together with icons number 6, 7 and 10.	

A.2 Maintenance INFO

The list of Maintenance INFO message is shown below.

Message	Explanation	Advice
Air Pressure(invalid)	There is a format error or a status error of the data.	Check the sensor condition.
Air Pressure(not plausible)	There is a range error of the data.	Check the sensor condition.
Air Pressure(unavailable)	The data cannot be received.	Check the condition of the sensor and the communication path.
Air TEMP(invalid)	There is a format error or a status error of the data.	Check the sensor condition.
Air TEMP(not plausible)	There is a range error of the data.	Check the sensor condition.
Air TEMP(unavailable)	The data cannot be received.	Check the condition of the sensor and the communication path.
AIS(Communication failed, Direct)	Communication with AIS cannot be performed via Serial.	Check the condition of AIS and Serial. If it cannot be recovered after you check the connection of the equipment cable in power-off status and restart, turn off the power of the device and contact your distributor.
AIS(Communication failed, Main LAN)	Communication with AIS cannot be performed via Main LAN.	Check the condition of AIS and Main LAN. If it cannot be recovered after you check the connection of the equipment cable in power-off status and restart, turn off the power of the device and contact your distributor.
AIS(Communication failed, Sub LAN)	Communication with AIS cannot be performed via Sub LAN.	Check the condition of AIS and Sub LAN. If it cannot be recovered after you check the connection of the equipment cable in power-off status and restart, turn off the power of the device and contact your distributor.
ALC #n(Communication failed, Main LAN)	Communication with ALC #n cannot be performed via Main LAN.	Check the condition of ALC #n and Main LAN. If it cannot be recovered after you check the connection of the equipment cable in power-off status and restart, turn off the power of the device and contact your distributor.
ALC #n(Communication failed, Sub LAN)	Communication with ALC #n cannot be performed via Sub LAN.	Check the condition of ALC #n and Sub LAN. If it cannot be recovered after you check the connection of the equipment cable in power-off status and restart, turn off the power of the device and contact your distributor.

Message	Explanation	Advice
Anemometer(Communication failed, Main LAN)	Communication with Anemometer cannot be performed via Main LAN.	Check the condition of Anemometer and Main LAN. If it cannot be recovered after you check the connection of the equipment cable in power-off status and restart, turn off the power of the device and contact your distributor.
Anemometer(Communication failed, Sub LAN)	Communication with Anemometer cannot be performed via Sub LAN.	Check the condition of Anemometer and Sub LAN. If it cannot be recovered after you check the connection of the equipment cable in power-off status and restart, turn off the power of the device and contact your distributor.
Autopilot(Communication Failed, Main LAN)	Communication with Autopilot cannot be performed via Main LAN.	Check the condition of Autopilot and Main LAN. If it cannot be recovered after you check the connection of the equipment cable in power-off status and restart, turn off the power of the device and contact your distributor.
Autopilot(Communication Failed, Sub LAN)	Communication with Autopilot cannot be performed via Sub LAN.	Check the condition of Autopilot and Sub LAN. If it cannot be recovered after you check the connection of the equipment cable in power-off status and restart, turn off the power of the device and contact your distributor.
Autopilot malfunction	AP equipment error	Turn off the power of the device and request the distributor to repair.
Autopilot(Invalid)	There is a format error or a status error of the Autopilot data.	Check the sensor condition. Switch to a sensor in good condition, if available.
Autopilot(Not Plausible)	There is a range error of Autopilot data.	Check the sensor condition. Switch to a sensor in good condition, if available.
Autopilot(Unavailable)	The Autopilot data cannot be received.	Check the condition of the sensor and the communication path. Switch to a sensor in good condition, if available.
Azimuth Thruster #n(invalid)	There is a format error or a status error of the data.	Check the sensor condition.
Azimuth Thruster #n(not plausible)	There is a range error of the data.	Check the sensor condition.
Azimuth Thruster #n(unavailable)	The data cannot be received.	Check the condition of the sensor and the communication path.
Blizzard(Process Error)	The control circuit in the radar antenna is abnormal.	Restart the power. If it cannot be recovered after three times of restart, turn off the device and contact the distributor.
Blizzard(SYNC Signal Lost)	ASIC for radar detected an error in an interrupt signal.	Restart the device.

Message	Explanation	Advice
Blizzard1 DSP1(Load Failed)	DSP cannot be started.	Restart the power. If it cannot be recovered after three times of restart, turn off the device and contact the distributor.
Blizzard1 DSP2(Load Failed)	DSP cannot be started.	Restart the power. If it cannot be recovered after three times of restart, turn off the device and contact the distributor.
Blizzard1 High TEMP	The temperature of Blizzard is too high.	Turn off the power of the device and restart after ten minutes. If it cannot be recovered, turn off the device and contact the distributor.
Blizzard1-DSP1(Communication error)	There is an error in communication with DSP.	Restart the power. If it cannot be recovered after three times of restart, turn off the device and contact the distributor.
Blizzard2 DSP1(Load Failed)	DSP cannot be started.	Restart the power. If it cannot be recovered after three times of restart, turn off the device and contact the distributor.
Blizzard2 High TEMP	The temperature of Blizzard is too high.	Turn off the power of the device and restart after ten minutes. If it cannot be recovered, turn off the device and contact the distributor.
Blizzard2-DSP1(Communication error)	There is an error in communication with DSP.	Restart the power. If it cannot be recovered after three times of restart, turn off the device and contact the distributor.
BNWAS(Communication failed, Main LAN)	Communication with BNWAS cannot be performed via Main LAN.	Check the condition of BNWAS and Main LAN. If it cannot be recovered after you check the connection of the equipment cable in power-off status and restart, turn off the power of the device and contact your distributor.
BNWAS(Communication failed, Sub LAN)	Communication with BNWAS cannot be performed via Sub LAN.	Check the condition of BNWAS and Sub LAN. If it cannot be recovered after you check the connection of the equipment cable in power-off status and restart, turn off the power of the device and contact your distributor.
Bow Azimuth Thruster #n (invalid)	There is a format error or a status error of the data.	Check the sensor condition.

Message	Explanation	Advice
Bow Azimuth Thruster #n (not plausible)	There is a range error of the data.	Check the sensor condition.
Bow Azimuth Thruster #n (unavailable)	The data cannot be received.	Check the condition of the sensor and the communication path.
Bow Thruster #n (invalid)	There is a format error or a status error of the data.	Check the sensor condition.
Bow Thruster #n (not plausible)	There is a range error of the data.	Check the sensor condition.
Bow Thruster #n (unavailable)	The data cannot be received.	Check the condition of the sensor and the communication path.
CCU Fan	The CCU unit fan revolution per minute has been decreased.	Request the distributor to repair.
CIF(Communication error)	There is an error in communication with Companion MPU.	Restart the power. If it cannot be recovered after three times of restart, turn off the device and contact the distributor.
CMP RelaySoftware(Communication error)	There is an error in communication with Companion MPU.	Restart the power. If it cannot be recovered after three times of restart, turn off the device and contact the distributor.
COG/SOG(invalid)	There is a format error or a status error of the SOG/COG data.	Check the sensor condition. Switch to a sensor in good condition, if available.
COG/SOG(not plausible)	There is a range error of SOG/COG data.	Check the sensor condition. Switch to a sensor in good condition, if available.
COG/SOG(unavailable)	The SOG/COG data cannot be received.	Check the condition of the sensor and the communication path. Switch to a sensor in good condition, if available.
CPU Core1 Clock down	The CPU core has been underclocked.	Turn off the power of the device and restart after ten minutes. If it cannot be recovered, turn off the device and contact the distributor.
CPU Core1 High TEMP	The CPU core temperature is too high.	Turn off the power of the device and restart after ten minutes. If it cannot be recovered, turn off the device and contact the distributor.
CPU Core2 Clock down	The CPU core has been underclocked.	Turn off the power of the device and restart after ten minutes. If it cannot be recovered, turn off the device and contact the distributor.
CPU Core2 High TEMP	The CPU core temperature is too high.	Turn off the power of the device and restart after ten minutes. If it cannot be recovered, turn off the device and contact the distributor.
CPU Fan	The RPS fan revolution per minute has been decreased.	Request the distributor to repair.
CPU High TEMP	The CPU temperature is too high.	Turn off the power of the device and restart after ten minutes. If it cannot be recovered, turn off the device and contact the distributor.

Message	Explanation	Advice
Current(Communication failed, Main LAN)	Communication with tidal current meter cannot be performed via Main LAN.	Check the condition of tidal current meter and Main LAN. If it cannot be recovered after you check the connection of the equipment cable in power-off status and restart, turn off the power of the device and contact your distributor.
Current(Communication failed, Sub LAN)	Communication with tidal current meter cannot be performed via Sub LAN.	Check the condition of tidal current meter and Sub LAN. If it cannot be recovered after you check the connection of the equipment cable in power-off status and restart, turn off the power of the device and contact your distributor.
Current(Invalid)	There is a format error or a status error of the Tidal Current data.	Check the sensor condition. Switch to a sensor in good condition, if available.
Current(not plausible)	There is a range error of Tidal Current data.	Check the sensor condition. Switch to a sensor in good condition, if available.
Current(unavailable)	The Tidal Current data cannot be received.	Check the condition of the sensor and the communication path. Switch to a sensor in good condition, if available.
DATUM(unavailable)	The DTM data cannot be received.	Check the condition of the sensor and the communication path. Switch to a sensor in good condition, if available.
Depth(Invalid)	There is a format error or a status error of the Depth data.	Check the sensor condition. Switch to a sensor in good condition, if available.
Dongle Disable Mode	It is operating in dongle-disabled mode when the USB dongle is in failure.	Request the distributor to provide a USB dongle.
Depth(unavailable)	The Depth data cannot be received.	Check the condition of the sensor and the communication path. Switch to a sensor in good condition, if available.
Draft(Invalid)	There is a format error or a status error of the data.	Check the sensor condition.
Draft(not plausible)	There is a range error of the data.	Check the sensor condition.
Draft(unavailable)	The data cannot be received.	Check the condition of the sensor and the communication path.
DSC(Communication failed, Main LAN)	Communication with DSC cannot be performed via Main LAN.	Check the condition of DSC and Main LAN. If it cannot be recovered after you check the connection of the equipment cable in power-off status and restart, turn off the power of the device and contact your distributor.

Message	Explanation	Advice
DSC(Communication failed, Sub LAN)	Communication with DSC cannot be performed via Sub LAN.	Check the condition of DSC and Sub LAN. If it cannot be recovered after you check the connection of the equipment cable in power-off status and restart, turn off the power of the device and contact your distributor.
DSP(Heading Data)	There is an error in the heading data received by DSP.	Restart the power. If it cannot be recovered after three times of restart, turn off the device and contact the distributor.
Dual Axis SOG(invalid)	There is a format error or a status error of the data.	Check the sensor condition.
Dual Axis SOG(not plausible)	There is a range error of the data.	Check the sensor condition.
Dual Axis SOG(unavailable)	The data cannot be received.	Check the condition of the sensor and the communication path.
Echo Sounder #n (Communication failed, Direct)	Communication with Echo Sounder cannot be performed via Serial.	Check the condition of Echo Sounder and Serial. If it cannot be recovered after you check the connection of the equipment cable in power-off status and restart, turn off the power of the device and contact your distributor.
Echo Sounder #n (Communication failed, Main LAN)	Communication with Echo Sounder cannot be performed via Main LAN.	Check the condition of Echo Sounder and Main LAN. If it cannot be recovered after you check the connection of the equipment cable in power-off status and restart, turn off the power of the device and contact your distributor.
Echo Sounder #n (Communication failed, Sub LAN)	Communication with Echo Sounder cannot be performed via Sub LAN.	Check the condition of Echo Sounder and Sub LAN. If it cannot be recovered after you check the connection of the equipment cable in power-off status and restart, turn off the power of the device and contact your distributor.
Engine Telegraph #n (invalid)	There is a format error or a status error of the data.	Check the sensor condition.
Engine Telegraph #n (not plausible)	There is a range error of the data.	Check the sensor condition.
Engine Telegraph #n (unavailable)	The data cannot be received.	Check the condition of the sensor and the communication path.
Engine/Propeller #n (invalid)	There is a format error or a status error of the data.	Check the sensor condition.
Engine/Propeller #n (not plausible)	There is a range error of the data.	Check the sensor condition.
Engine/Propeller #n (unavailable)	The data cannot be received.	Check the condition of the sensor and the communication path.
e-Token(Communication error)	There is an error in communication with e-Token.	Restart the device. If it cannot be recovered after three times of restart, turn off the device and contact the distributor.

Message	Explanation	Advice
General Equipment #n (Communication Failed, Main LAN)	Communication with General Equipment #n cannot be performed via Main LAN.	Check the condition of General Equipment #n and Main LAN. If it cannot be recovered after you check the connection of the equipment cable in power-off status and restart, turn off the power of the device and contact your distributor.
General Equipment #n (Communication Failed, Sub LAN)	Communication with General Equipment #n cannot be performed via Sub LAN.	Check the condition of General Equipment #n and Sub LAN. If it cannot be recovered after you check the connection of the equipment cable in power-off status and restart, turn off the power of the device and contact your distributor.
Generator #n (invalid)	There is a format error or a status error of the data.	Check the sensor condition.
Generator #n (not plausible)	There is a range error of the data.	Check the sensor condition.
Generator #n (unavailable)	The data cannot be received.	Check the condition of the sensor and the communication path.
GIF(Communication error)	There is a communication error with Gyro IF.	Restart the power. If it cannot be recovered after three times of restart, turn off the device and contact the distributor.
GIF-RIF(Open)	GIF-RIF open is detected.	Check the status of the cable (W81 in Junction Box:NQE-1143).
GIF-SLC(Open)	GIF-SLC open is detected.	Check the status of the cable (W82 in Junction Box:NQE-1143).
GPS #n (Communication Failed, Direct)	Communication with GPS #n cannot be performed via Serial.	Check the condition of GPS #n and Serial. If it cannot be recovered after you check the connection of the equipment cable in power-off status and restart, turn off the power of the device and contact your distributor.
GPS #n (Communication Failed, Main LAN)	Communication with GPS #n cannot be performed via Main LAN.	Check the condition of GPS #n and Main LAN. If it cannot be recovered after you check the connection of the equipment cable in power-off status and restart, turn off the power of the device and contact your distributor.
GPS #n (Communication Failed, Sub LAN)	Communication with GPS #n cannot be performed via Sub LAN.	Check the condition of GPS #n and Sub LAN. If it cannot be recovered after you check the connection of the equipment cable in power-off status and restart, turn off the power of the device and contact your distributor.
GPS Compass #n (Communication failed, Direct)	Communication with GPS Compass #n cannot be performed via Serial.	Check the condition of GPS Compass #n and Serial. If it cannot be recovered after you check the connection of the equipment cable in power-off status and restart, turn off the power of the device and contact your distributor.

Message	Explanation	Advice
GPS Compass #n (Communication failed, Main LAN)	Communication with GPS Compass #n cannot be performed via Main LAN.	Check the condition of GPS Compass #n and Main LAN. If it cannot be recovered after you check the connection of the equipment cable in power-off status and restart, turn off the power of the device and contact your distributor.
GPS Compass #n (Communication failed, Sub LAN)	Communication with GPS Compass #n cannot be performed via Sub LAN.	Check the condition of GPS Compass #n and Sub LAN. If it cannot be recovered after you check the connection of the equipment cable in power-off status and restart, turn off the power of the device and contact your distributor.
GPS Selector(Communication Failed, Direct)	Communication with GPS Selector cannot be performed via Serial.	Check the condition of GPS Selector and Serial. If it cannot be recovered after you check the connection of the equipment cable in power-off status and restart, turn off the power of the device and contact your distributor.
Gyro #n (Communication Failed, Direct)	Communication with Gyro #n cannot be performed via Serial.	Check the condition of Gyro #n and Serial. If it cannot be recovered after you check the connection of the equipment cable in power-off status and restart, turn off the power of the device and contact your distributor.
Gyro #n (Communication Failed, GIF-Direct)	Communication with Gyro #n cannot be performed via Serial.	Check the condition of Gyro #n, GIF and Serial. If it cannot be recovered after you check the connection of the equipment cable in power-off status and restart, turn off the power of the device and contact your distributor.
Gyro #n (Communication Failed, GIF-Main LAN)	Communication with Gyro #n cannot be performed via Main LAN.	Check the condition of Gyro #n, GIF and Main LAN. If it cannot be recovered after you check the connection of the equipment cable in power-off status and restart, turn off the power of the device and contact your distributor.
Gyro #n (Communication Failed, GIF-Sub LAN)	Communication with Gyro #n cannot be performed via Sub LAN.	Check the condition of Gyro #n, GIF and Sub LAN. If it cannot be recovered after you check the connection of the equipment cable in power-off status and restart, turn off the power of the device and contact your distributor.
Gyro #n (Communication Failed, Main LAN)	Communication with Gyro #n cannot be performed via Main LAN.	Check the condition of Gyro #n and Main LAN. If it cannot be recovered after you check the connection of the equipment cable in power-off status and restart, turn off the power of the device and contact your distributor.

Message	Explanation	Advice
Gyro #n (Communication Failed, Sub LAN)	Communication with Gyro #n cannot be performed via Sub LAN.	Check the condition of Gyro #n and Sub LAN. If it cannot be recovered after you check the connection of the equipment cable in power-off status and restart, turn off the power of the device and contact your distributor.
HASP(Communication error)	There is an error in communication with HASP.	Restart the power. If it cannot be recovered after three times of restart, turn off the device and contact the distributor.
HDG(No Correction)	No correction included in heading	Perform the operation carefully.
HDOP exceeded(GPS #n)	The GPS #n precision is deteriorated.	Check the sensor condition.
Heading(Invalid)	There is a format error or a status error of the Heading data.	Check the sensor condition. Switch to a sensor in good condition, if available.
Heading(not plausible)	There is a range error of Heading data.	Check the sensor condition. Switch to a sensor in good condition, if available.
Heading(unavailable)	The Heading data cannot be received.	Check the condition of the sensor and the communication path. Switch to a sensor in good condition, if available.
Hull Motion(Invalid)	There is a format error or a status error of the data.	Check the sensor condition.
Hull Motion(not plausible)	There is a range error of the data.	Check the sensor condition.
Hull Motion(unavailable)	The data cannot be received.	Check the condition of the sensor and the communication path.
Humidity(Invalid)	There is a format error or a status error of the data.	Check the sensor condition.
Humidity(not plausible)	There is a range error of the data.	Check the sensor condition.
Humidity(unavailable)	The data cannot be received.	Check the condition of the sensor and the communication path.
IAS Primary(Communication Failed, Main LAN)	Communication with IAS cannot be performed via Main LAN.	Check the condition of IAS and Main LAN. If it cannot be recovered after you check the connection of the equipment cable in power-off status and restart, turn off the power of the device and contact your distributor.
IAS Primary(Communication Failed, Sub LAN)	Communication with IAS cannot be performed via Sub LAN.	Check the condition of IAS and Sub LAN. If it cannot be recovered after you check the connection of the equipment cable in power-off status and restart, turn off the power of the device and contact your distributor.
IAS Secondary(Communication Failed, Main LAN)	Communication with IAS cannot be performed via Main LAN.	Check the condition of IAS and Main LAN. If it cannot be recovered after you check the connection of the equipment cable in power-off status and restart, turn off the power of the device and contact your distributor.
IAS Secondary(Communication Failed, Sub LAN)	Communication with IAS cannot be performed via Sub LAN.	Check the condition of IAS and Sub LAN. If it cannot be recovered after you check the connection of the equipment cable in power-off status and restart, turn off the power of the device and contact your distributor.

Message	Explanation	Advice
IAS(Communication failed, Main LAN)	Communication with IAS cannot be performed via Main LAN.	Check the condition of IAS and Main LAN. If it cannot be recovered after you check the connection of the equipment cable in power-off status and restart, turn off the power of the device and contact your distributor.
IAS(Communication failed, Sub LAN)	Communication with IAS cannot be performed via Sub LAN.	Check the condition of IAS and Sub LAN. If it cannot be recovered after you check the connection of the equipment cable in power-off status and restart, turn off the power of the device and contact your distributor.
ISW(Communication error)	There is a communication error with ISW.	If it cannot be recovered after you check the connection of the equipment cable in power-off status and restart, turn off the power of the device and contact your distributor.
Joystick(Communication Failed, MainLAN)	A communication error with MJS via Main LAN was detected.	Check MJS. If it cannot be recovered after you check the connection of the equipment cable in power-off status and restart, turn off the power of the device and contact your distributor.
Joystick(Communication Failed, SubLAN)	A communication error with MJS via Sub LAN was detected.	Check MJS. If it cannot be recovered after you check the connection of the equipment cable in power-off status and restart, turn off the power of the device and contact your distributor.
LCD Fan #n(LCD)	The fan in the display unit has stopped.	Restart the power. If it cannot be recovered after three times of restart, turn off the device and contact the distributor.
LCD High TEMP	The temperature of LCD is too high. It will be dim or dark.	Turn off the power of the device and restart after ten minutes. If it cannot be recovered, turn off the device and contact the distributor.
Log #n (Communication failed, Direct)	Communication with Log #n cannot be performed via Serial.	Check the condition of Log #n and Serial. If it cannot be recovered after you check the connection of the equipment cable in power-off status and restart, turn off the power of the device and contact your distributor.
Log #n (Communication failed, GIF-Direct)	Communication with Log #n cannot be performed via Serial.	Check the condition of Log #n, GIF and Serial. If it cannot be recovered after you check the connection of the equipment cable in power-off status and restart, turn off the power of the device and contact your distributor.
Log #n (Communication failed, GIF-Main LAN)	Communication with Log #n cannot be performed via Main LAN.	Check the condition of Log #n, GIF and Main LAN. If it cannot be recovered after you check the connection of the equipment cable in power-off status and restart, turn off the power of the device and contact your distributor.

Message	Explanation	Advice
Log #n (Communication failed, GIF-Sub LAN)	Communication with Log #n cannot be performed via Sub LAN.	Check the condition of Log #n, GIF and Sub LAN. If it cannot be recovered after you check the connection of the equipment cable in power-off status and restart, turn off the power of the device and contact your distributor.
Log #n (Communication failed, Main LAN)	Communication with Log #n cannot be performed via Main LAN.	Check the condition of Log #n and Main LAN. If it cannot be recovered after you check the connection of the equipment cable in power-off status and restart, turn off the power of the device and contact your distributor.
Log #n (Communication failed, Sub LAN)	Communication with Log #n cannot be performed via Sub LAN.	Check the condition of Log #n and Sub LAN. If it cannot be recovered after you check the connection of the equipment cable in power-off status and restart, turn off the power of the device and contact your distributor.
Log Selector(Communication failed, Direct)	Communication with Log Selector cannot be performed via Serial.	Check the condition of Log Selector and Serial. If it cannot be recovered after you check the connection of the equipment cable in power-off status and restart, turn off the power of the device and contact your distributor.
Magnetic Compass #n (Communication failed, Direct)	Communication with Magnetic Compass #n cannot be performed via Serial.	Check the condition of Magnetic Compass #n and Serial. If it cannot be recovered after you check the connection of the equipment cable in power-off status and restart, turn off the power of the device and contact your distributor.
Magnetic Compass #n (Communication failed, Main LAN)	Communication with Magnetic Compass #n cannot be performed via Main LAN.	Check the condition of Magnetic Compass #n and Main LAN. If it cannot be recovered after you check the connection of the equipment cable in power-off status and restart, turn off the power of the device and contact your distributor.
Magnetic Compass #n (Communication failed, Sub LAN)	Communication with Magnetic Compass #n cannot be performed via Sub LAN.	Check the condition of Magnetic Compass #n and Sub LAN. If it cannot be recovered after you check the connection of the equipment cable in power-off status and restart, turn off the power of the device and contact your distributor.
MJS IF <-> AP(Communication error)	MJS detected a communication error with AP.	Check AP. If it cannot be recovered after you check the connection of the equipment cable in power-off status and restart, turn off the power of the device and contact your distributor.
MJS IF(Unit failure)	An error occurred in the MJS unit.	Turn off the power of the device and request the distributor to repair.

Message	Explanation	Advice
MJS OPE <-> MJS IF(Communication error)	MJS detected a communication error with MJS I/O.	Turn off the power of the device and request the distributor to repair.
MJS OPE(Unit failure)	An error occurred in the MJS equipment.	Turn off the power of the device and request the distributor to repair.
Multi Current(unavailable)	The data cannot be received.	Check the condition of the sensor and the communication path.
NAVTEX(Communication failed, Main LAN)	Communication with NAVTEX cannot be performed via Main LAN.	Check the condition of NAVTEX and Main LAN. If it cannot be recovered after you check the connection of the equipment cable in power-off status and restart, turn off the power of the device and contact your distributor.
NAVTEX(Communication failed, Sub LAN)	Communication with NAVTEX cannot be performed via Sub LAN.	Check the condition of NAVTEX and Sub LAN. If it cannot be recovered after you check the connection of the equipment cable in power-off status and restart, turn off the power of the device and contact your distributor.
No.#n Conning(Communication failed, Main LAN)	Communication with No. #n Conning cannot be performed via Main LAN.	Check the condition of No. #n Conning and Main LAN. If it cannot be recovered after you check the connection of the equipment cable in power-off status and restart, turn off the power of the device and contact your distributor.
No.#n Conning(Communication failed, Sub LAN)	Communication with No. #n Conning cannot be performed via Sub LAN.	Check the condition of No. #n Conning and Sub LAN. If it cannot be recovered after you check the connection of the equipment cable in power-off status and restart, turn off the power of the device and contact your distributor.
No. #n ECDIS(Communication failed, Main LAN)	Communication with No. #n ECDIS cannot be performed via Main LAN.	Check the condition of No. #n ECDIS and Main LAN. If it cannot be recovered after you check the connection of the equipment cable in power-off status and restart, turn off the power of the device and contact your distributor.
No. #n ECDIS(Communication failed, Sub LAN)	Communication with No. #n ECDIS cannot be performed via Sub LAN.	Check the condition of No. #n ECDIS and Sub LAN. If it cannot be recovered after you check the connection of the equipment cable in power-off status and restart, turn off the power of the device and contact your distributor.
No. #n Radar(Communication failed, Main LAN)	Communication with No. #n RADAR cannot be performed via Main LAN.	Check the condition of No. #n RADAR and Main LAN. If it cannot be recovered after you check the connection of the equipment cable in power-off status and restart, turn off the power of the device and contact your distributor.

Message	Explanation	Advice
No. #n Radar(Communication failed, Sub LAN)	Communication with No. #n RADAR cannot be performed via Sub LAN.	Check the condition of No. #n RADAR and Sub LAN. If it cannot be recovered after you check the connection of the equipment cable in power-off status and restart, turn off the power of the device and contact your distributor.
No. #n Remote-Conning(Communication failed, Main LAN)	Communication with No. #n Remote-Conning cannot be performed via Main LAN.	Check the condition of No. #n Remote-Conning and Main LAN. If it cannot be recovered after you check the connection of the equipment cable in power-off status and restart, turn off the power of the device and contact your distributor.
No. #n Remote-Conning(Communication failed, Sub LAN)	Communication with No. #n Remote-Conning cannot be performed via Sub LAN.	Check the condition of No. #n Remote-Conning and Sub LAN. If it cannot be recovered after you check the connection of the equipment cable in power-off status and restart, turn off the power of the device and contact your distributor.
No. #n RPS(Communication failed, Main LAN)	Communication with No. #n RPS cannot be performed via Main LAN.	Check the condition of No. #n RPS and Main LAN. If it cannot be recovered after you check the connection of the equipment cable in power-off status and restart, turn off the power of the device and contact your distributor.
No. #n RPS(Communication failed, Sub LAN)	Communication with No. #n RPS cannot be performed via Sub LAN.	Check the condition of No. #n RPS and Sub LAN. If it cannot be recovered after you check the connection of the equipment cable in power-off status and restart, turn off the power of the device and contact your distributor.
No. #n Wing-Conning(Communication failed, Main LAN)	Communication with No. #n Wing-Conning cannot be performed via Main LAN.	Check the condition of No. #n Wing-Conning and Main LAN. If it cannot be recovered after you check the connection of the equipment cable in power-off status and restart, turn off the power of the device and contact your distributor.
No. #n Wing-Conning(Communication failed, Sub LAN)	Communication with No. #n Wing-Conning cannot be performed via Sub LAN.	Check the condition of No. #n Wing-Conning and Sub LAN. If it cannot be recovered after you check the connection of the equipment cable in power-off status and restart, turn off the power of the device and contact your distributor.
OPA-OPB(Communication error)	-	-
OPU-Serial(Communication error)	There is a communication error with the operating portion.	Restart the power. If it cannot be recovered after three times of restart, turn off the device and contact the distributor.
OPU-USB(Communication error)	There is a communication error with the operating portion.	Restart the power. If it cannot be recovered after three times of restart, turn off the device and contact the distributor.

Message	Explanation	Advice
Port Main Propeller(Invalid)	There is a format error or a status error of the data.	Check the sensor condition.
Port Main Propeller(not plausible)	There is a range error of the data.	Check the sensor condition.
Port Main Propeller(unavailable)	The data cannot be received.	Check the condition of the sensor and the communication path.
Position(doubtful)	The integrity of Position cannot be verified.	Check the sensor condition. Switch to a sensor in good condition.
Position(failed)	The Position has been rejected by the integrity verification.	Check the sensor condition. Switch to a sensor in good condition.
Position(doubtful)	The integrity of Position cannot be verified.	Check the sensor condition. Switch to a sensor in good condition.
Position(failed)	The Position has been rejected by the integrity verification.	Check the sensor condition. Switch to a sensor in good condition.
Position(Invalid)	There is a format error or a status error of the Position data.	Check the sensor condition. Switch to a sensor in good condition, if available.
Position(not plausible)	There is a range error of Position data.	Check the sensor condition. Switch to a sensor in good condition, if available.
Position(unavailable)	The Position data cannot be received.	Check the condition of the sensor and the communication path. Switch to a sensor in good condition, if available.
POSN(GPS#n) Not Differential	Differential operation is not performed by GPS#n.	Check the sensor condition.
POSN(Low Integrity, GPS#n)	Integrity of the GPS position is low.	Perform the operation carefully.
POSN(Navigational Status Not Valid, GPS#n)	Navigational status of GPS is not valid.	Perform the operation carefully.
Power Fail	Power incoming of 3.3V/2.5V/1.5V/1.2V etc. has decreased and stopped.	Check the electronic power supply.
Power(Fan)	A failure of the fan in the power supply unit has been detected.	Restart the power. If it cannot be recovered after three times of restart, turn off the device and contact the distributor.
Power(TXRX, Failed)	There is an error in the power supply unit for the radar antenna.	Turn off the power of the device and request the distributor to repair.

Message	Explanation	Advice
PROC(AZI)	An azimuth signal error has occurred at the signal processing unit.	Turn off the power of the device and check the connection of the equipment cable. If it cannot be recovered after three times of restart, turn off the device and contact the distributor.
PROC(HL)	A heading line signal error has occurred at the signal processing unit.	Turn off the power of the device and check the connection of the equipment cable. If it cannot be recovered after three times of restart, turn off the device and contact the distributor.
PROC(Interrupt#n)	There is a stern interrupt error in the signal processing unit.	Restart the power. If it cannot be recovered after three times of restart, turn off the device and contact the distributor.
PROC(Trigger)	A trigger signal error has occurred at the signal processing unit.	Turn off the power of the device and check the connection of the equipment cable. If it cannot be recovered after three times of restart, turn off the device and contact the distributor.
PROC(Video)	A radar image signal error has occurred at the signal processing unit.	Turn off the power of the device and check the connection of the equipment cable. If it cannot be recovered after three times of restart, turn off the device and contact the distributor.
RADAR PROC(Data)	Control of radar signal/image processing failed.	Restart the power. If it cannot be recovered after three times of restart, turn off the device and contact the distributor.
RIF(Communication error)	There is an error in communication with RIF.	Restart the power. If it cannot be recovered after three times of restart, turn off the device and contact the distributor.
ROT(invalid)	There is a format error or a status error of the ROT data.	Check the sensor condition.
ROT(unavailable)	The ROT data cannot be received.	Check the condition of the sensor and the communication path.
RTC Abnormal	RTC is abnormal.	Restart the power. If it cannot be recovered after three times of restart, contact the distributor.
Rudder #n(invalid)	There is a format error or a status error of the Rudder data.	Check the sensor condition.
Rudder #n(not plausible)	There is a range error of Rudder data.	Check the sensor condition.
Rudder #n(unavailable)	The Rudder data cannot be received.	Check the condition of the sensor and the communication path.
Rudder(Communication failed, Main LAN)	Communication with Rudder cannot be performed via Main LAN.	Check the condition of Rudder and Main LAN. If it cannot be recovered after you check the connection of the equipment cable in power-off status and restart, turn off the power of the device and contact your distributor.
Rudder(Communication failed, Sub LAN)	Communication with Rudder cannot be performed via Sub LAN.	Check the condition of Rudder and Sub LAN. If it cannot be recovered after you check the connection of the equipment cable in power-off status and restart, turn off the power of the device and contact your distributor.

Message	Explanation	Advice
Sea TEMP(invalid)	There is a format error or a status error of the Water temperature data.	Check the sensor condition. Switch to a sensor in good condition, if available.
Sea TEMP(unavailable)	The Water temperature data cannot be received.	Check the condition of the sensor and the communication path. Switch to a sensor in good condition, if available.
Ship's clock(Communication failed, Main LAN)	Communication with Ship's clock cannot be performed via Main LAN.	Check the condition of Ship's clock and Main LAN. If it cannot be recovered after you check the connection of the equipment cable in power-off status and restart, turn off the power of the device and contact your distributor.
Ship's clock(Communication failed, Sub LAN)	Communication with Ship's clock cannot be performed via Sub LAN.	Check the condition of Ship's clock and Sub LAN. If it cannot be recovered after you check the connection of the equipment cable in power-off status and restart, turn off the power of the device and contact your distributor.
S-J I/O <-> AP(Communication error)	S-JOY detected a communication error with AP.	Check AP. If it cannot be recovered after you check the connection of the equipment cable in power-off status and restart, turn off the power of the device and contact your distributor.
S-J I/O Time Out	A communication error with S-JOY was detected.	Check S-JOY. If it cannot be recovered after you check the connection of the equipment cable in power-off status and restart, turn off the power of the device and contact your distributor.
S-J I/O(Unit failure)	An error occurred in the S-JOY unit.	Turn off the power of the device and request the distributor to repair.
S-JOY <-> S-J I/O(Communication error)	S-JOY detected a communication error with S-JOY I/O.	Turn off the power of the device and request the distributor to repair.
S-JOY(Unit failure)	An error occurred in the S-JOY equipment.	Turn off the power of the device and request the distributor to repair.
SLC1 - #n (Communication failed, Main LAN)	Communication with SLC1-#n cannot be performed via Main LAN.	Check the condition of SLC1-#n and Main LAN. If it cannot be recovered after you check the connection of the equipment cable in power-off status and restart, turn off the power of the device and contact your distributor.
SLC2- #n (Communication failed, Sub LAN)	Communication with SLC2-#n cannot be performed via Sub LAN.	Check the condition of SLC2-#n and Sub LAN. If it cannot be recovered after you check the connection of the equipment cable in power-off status and restart, turn off the power of the device and contact your distributor.
Stbd Main Propeller(invalid)	There is a format error or a status error of the data.	Check the sensor condition.

Message	Explanation	Advice
Stbd Main Propeller(not plausible)	There is a range error of the data.	Check the sensor condition.
Stbd Main Propeller(unavailable)	The data cannot be received.	Check the condition of the sensor and the communication path.
Stern Thruster #n (invalid)	There is a format error or a status error of the data.	Check the sensor condition.
Stern Thruster #n (not plausible)	There is a range error of the data.	Check the sensor condition.
Stern Thruster #n (unavailable)	The data cannot be received.	Check the condition of the sensor and the communication path.
STW Speed(invalid)	There is a format error or a status error of the STW data.	Check the sensor condition. Switch to a sensor in good condition, if available.
STW Speed(unavailable)	The STW data cannot be received.	Check the condition of the sensor and the communication path. Switch to a sensor in good condition, if available.
Time(invalid)	There is a format error or a status error of the Time data.	Check the sensor condition. Switch to a sensor in good condition, if available.
Time(unavailable)	The Time data cannot be received.	Check the condition of the sensor and the communication path. Switch to a sensor in good condition, if available.
TXRX(AZI)	Azimuth signals cannot be recognized in the radar antenna.	Confirm that the status is standby and, if the status is transmitting, set the status to standby. After that, set the status to transmitting again. If it cannot be recovered in this transmitting state, visually confirm that the antenna of radar antenna is rotating in a proper way. If the rotation of the antenna has been able to be confirmed, turn off the power of the device and, after confirming cable connection of the encoder in the radar antenna, turn the power on again. If it cannot be recovered after the operation above, turn off the device and contact the distributor.
TXRX(Communication error)	There is a communication error with radar antenna.	Confirm that the setting of the instruction machine is Master. If it cannot be recovered after you check the connection of the equipment cable in power-off status and restart, turn off the power of the device and contact your distributor.
TXRX(DRV AC LKV)	The supply voltage of the motor driver circuit in the radar antenna falls short of the rated value.	Turn off the power of the device and check the connection of the equipment cable. If it cannot be recovered after three times of restart, turn off the device and contact the distributor. Turn off the power of the device if it is equipped and check the AC power voltage provided to the radar antenna and the DIP switch setting of the motor driver circuit.

Message	Explanation	Advice
TXRX(DRV AC OVV)	The supply voltage of the motor driver circuit in the radar antenna exceeds the rated value.	Turn off the power of the device and check the connection of the equipment cable. If it cannot be recovered after three times of restart, turn off the device and contact the distributor. Turn off the power of the device if it is equipped and check the AC power voltage provided to the radar antenna and the DIP switch setting of the motor driver circuit.
TXRX(DRV COM)	The communication with the motor driver circuit in the radar antenna is abnormal.	Restart the power. If it cannot be recovered after three times of restart, turn off the device and contact the distributor.
TXRX(DRV CPU1)	The control unit of the motor driver circuit in the radar antenna is abnormal.	Restart the power. If it cannot be recovered after three times of restart, turn off the device and contact the distributor.
TXRX(DRV Hall Sensor)	The rotation sensor of the motor in the radar antenna is abnormal.	Restart the power. If it cannot be recovered after three times of restart, turn off the device and contact the distributor.
TXRX(DRV High Rotate)	The rotation speed of the antenna is higher than the specification.	Confirm that the status is standby and, if the status is transmitting, set the status to standby. After that, set the status to transmitting again. If it cannot be recovered after repeating the above operation three times, turn off the device and contact the distributor.
TXRX(DRV IPM OVH)	The temperature of IPM of the motor driver circuit in the radar antenna is abnormal.	Turn off the power of the device and restart after ten minutes. If it cannot be recovered, turn off the device and contact the distributor.
TXRX(DRV Low Rotate)	The rotation speed of the antenna is lower than the specification.	Confirm that the status is standby and, if the status is transmitting, set the status to standby. After that, set the status to transmitting again. If it cannot be recovered after repeating the above operation three times, turn off the device and contact the distributor.
TXRX(DRV MOT OVH)	The temperature of the motor in the radar antenna is abnormal.	Turn off the power of the device and restart after ten minutes. If it cannot be recovered, turn off the device and contact the distributor.
TXRX(DRV OVC)	The supply current of the motor in the radar antenna exceeds the rated value.	Confirm that the status is standby and, if the status is transmitting, set the status to standby. Then, after confirming that there is no obstruction in the swing circle of the antenna, set the status to transmitting again. If it cannot be recovered after the operation above, turn off the device and contact the distributor.
TXRX(DRV Over Rotate)	The rotation speed of the antenna is abnormally higher than the specification.	Confirm that the status is standby and, if the status is transmitting, set the status to standby. After that, set the status to transmitting again. If it cannot be recovered after repeating the above operation three times, turn off the device and contact the distributor.

Message	Explanation	Advice
TXRX(DRV VBUS LKV)	The supply voltage of the motor in the radar antenna falls short of the rated value.	Restart the power. If it cannot be recovered after three times of restart, turn off the device and contact the distributor.
TXRX(DRV VBUS OVV)	The supply voltage of the motor in the radar antenna exceeds the rated value.	Restart the power. If it cannot be recovered after three times of restart, turn off the device and contact the distributor.
TXRX(Fan#n)	Fan #n in the radar antenna is abnormal.	Restart the power. If it cannot be recovered after three times of restart, turn off the device and contact the distributor.
TXRX(Heater)	The heater voltage of the magnetron in the radar antenna is abnormal.	Restart the power. If it cannot be recovered after three times of restart, turn off the device and contact the distributor.
TXRX(High Temperature)	The temperature in the radar antenna is abnormal.	Turn off the power of the device and restart after ten minutes. If it cannot be recovered, turn off the device and contact the distributor.
TXRX(HL)	Azimuth reference signals cannot be recognized in the radar antenna.	Confirm that the status is standby and, if the status is transmitting, set the status to standby. After that, set the status to transmitting again. If it cannot be recovered in this transmitting state, visually confirm that the antenna of radar antenna is rotating in a proper way. If the rotation of the antenna has been able to be confirmed, turn off the power of the device and, after confirming cable connection of the encoder in the radar antenna, turn the power on again. If it cannot be recovered after the operation above, turn off the device and contact the distributor.
TXRX(IF PLL)	The transmitting signal clock in the radar antenna part is in an error state.	Restart the power. If it cannot be recovered after three times of restart, turn off the device and contact the distributor.
TXRX(LO PLL)	The radar antenna detected a problem with the LO frequency.	Restart the device.
TXRX(MHV)	The supply voltage to the magnetron in the radar antenna is abnormal.	Restart the power. If it cannot be recovered after three times of restart, turn off the device and contact the distributor.
TXRX(Option)	The option equipment in the radar antenna is abnormal.	Restart the power. If it cannot be recovered after three times of restart, turn off the device and contact the distributor.
TXRX(PROC)	The radar antenna detected a problem with the signal control circuit.	Restart the device.

Message	Explanation	Advice
TXRX(PS)	The power supply circuit in the radar antenna is abnormal.	Restart the power. If it cannot be recovered after three times of restart, turn off the device and contact the distributor.
TXRX(Trigger)	There is possibility that timing reference signals are not normally output from the radar antenna.	Restart the power. If it cannot be recovered after three times of restart, turn off the device and contact the distributor.
TXRX(Video)	There is possibility that radar image signals are not normally output from the radar antenna.	Restart the power. If it cannot be recovered after three times of restart, turn off the device and contact the distributor.
VDR(Communication failed, Main LAN)	Communication with VDR cannot be performed via Main LAN.	Check the condition of VDR and Main LAN. If it cannot be recovered after you check the connection of the equipment cable in power-off status and restart, turn off the power of the device and contact your distributor.
VDR(Communication failed, Sub LAN)	Communication with VDR cannot be performed via Sub LAN.	Check the condition of VDR and Sub LAN. If it cannot be recovered after you check the connection of the equipment cable in power-off status and restart, turn off the power of the device and contact your distributor.
Water Thermometers(Communication failed, Main LAN)	Communication with Water Thermometer cannot be performed via Main LAN.	Check the condition of Water Thermometer and Main LAN. If it cannot be recovered after you check the connection of the equipment cable in power-off status and restart, turn off the power of the device and contact your distributor.
Water Thermometers(Communication failed, Sub LAN)	Communication with Water Thermometer cannot be performed via Sub LAN.	Check the condition of Water Thermometer and Sub LAN. If it cannot be recovered after you check the connection of the equipment cable in power-off status and restart, turn off the power of the device and contact your distributor.
Wind(Invalid)	There is a format error or a status error of the Wind data.	Check the sensor condition. Switch to a sensor in good condition, if available.
Wind(not plausible)	There is a range error of Wind data.	Check the sensor condition. Switch to a sensor in good condition, if available.
Wind(unavailable)	The Wind data cannot be received.	Check the condition of the sensor and the communication path. Switch to a sensor in good condition, if available.

A.3 Permanent Information

The list of Permanent Information is shown below.

Message	Explanation
Chart information not up to date	The cell that is not the latest is displayed in the View (S-57)
Chart license expired (SSE 25)	The chart license has expired
Datum of position different from WGS-84.	Different geodetic datum and Datum shift not known occur simultaneously
Datum shift not known	Unknown shift amount of RNC chart
Indication of crossing safety contour is Off	Safety contour highlight is OFF
Indication of navigational hazard is Off	Navigational hazard is OFF
Indication of some prohibited areas or areas with special conditions is Off	Specific area highlight is OFF
Information overscale	When own ship moves to another chart, the chart is expanded to the double scale or more of the chart scale
Larger scale ENC available	A detail chart is available
Larger scale information available, overscale	From the scale described in RNC, the display scale is larger
Larger scale information available, underscale	From the scale described in RNC, the display scale is smaller
Larger scale RNC available for the area of the vessel	A cell with a larger scale than the chart displayed at its own ship position is included. (in ARCS)
No ENC Available	Scaling factor/sea area chart to be indicated is unavailable in ECDIS
No RNC at a scale appropriate for navigation	There is no RNC in its ship's position
non-ENC data	ENC of non-HO is displayed or ENC of own ship position is non-HO
Overlapped charts of the same purpose	Charts of the same purpose are duplicated
SSE27 Following cells are not up to date	The cell that is not the latest is displayed in the View (S-63)
Standard display is customized	Standard display item is displayed OFF
Viewing Does Not Include Current Date	View display does not include current date



Appendix B Menu List and Materials

B.1 Menu List

This section shows the menus and dialog items of this equipment by target menu.

*ECDIS CONNING indicates the task that is targeted for display.

*Items that are enclosed by a frame of broken lines indicate the dialog and window names that are displayed by selecting the relevant menu.

B.1.1 Route Planning

ECDIS

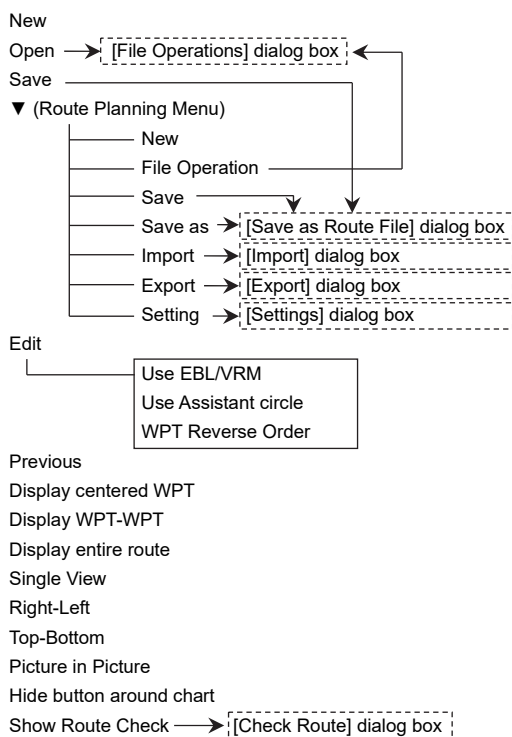

Planned Route tab

Insert

Delete

Comment

(WPT list)

WPT No.
Name
Position-LAT
Position-LON
Leg-Course
Leg-Distance
Sail
XTD-PORT
XTD-STBD
Arrival Radius
Turning Radius
Plan Speed
ROT
ETA
Time Zone
TWOL
Total Distance

B.1.2 Route Monitoring

ECDIS

Route

To WPT

[File Operations] dialog box display button → [File Operations] dialog box

Voyage Information → [Voyage Information] dialog box

Voyage Calculation → [Voyage Calculation] dialog box

Pair of data → [Pair of data] dialog box

B.1.3 Anchor Watch

ECDIS

Monitoring Anchor

Mode

(Mode: Selecting [Circle])

Position

Radius

(Mode: Selecting [Polygon])

New

Point

(list)

B.1.4 Autosail * ECDIS

*Displayed when the automatic sailing option is attached.

* In case of JAN-7201S/9201S, the function is not available by function restriction.

(Select Route)

[Track
Click here to plan a new track
Click here to confirm and modify the track.
Next]

Select WPT

[TO-WPT
Start
Back]

B.1.5 Chart

ECDIS

Manual Update

- Select Chart → [Select Chart] dialog box
- Save
- Chart Name
- FIX
- Comment
- Review
- Load → [Load Update log] dialog

My Port List

- Save
- My Port List
- Delete
- Jump

Select S-57 Chart

- Search
- Chart List
- Reset Picked Chart
- OK

Off Center by Entering Position

- Jump to the following position
- LAT/LON

Update Review

- S-57 Chart List
- Show
- Accept
- Reject

Date-dependent View

- Enable Date-dependent View
- UTC/LMT
- Start Date Time
- End Date Time
- Calendar Icon
- Time Zone

Graphical Index

- Chart Boundary
 - Overview
 - General
 - Coastal
 - Approach
 - Harbour
 - Berthing
 - Show Chart Name
 - Show ENC Data
 - (Active Indicator)

[Edition and date of chart] dialog box*

* Displayed when the chart is clicked on while the [Graphical Index] dialog box appears.

** While C-MAP is displayed, [Show ENC Data] of the [Graphical Index] dialog box is hidden.

Chart Abbreviation

T & P (ARCS)

- Number
- Temporary and Preliminary Notice to Mariners
- Datum Offset(ARCS)
- Offset by Cursor
- Clear Offset
- Offset

ENC Update Status Report

Route Filter
Select Route
[File Operations] dialog display button → [File Operations] dialog
InFormation
Summary
Status Report

ECDIS Chart1

Information about Chart Display1
Information about Chart Diaplay2
Natural and Man-made Features
Depth, Cerrents, Etc.
Sea, Obstructions, Pipelines, Etc.
Traffic Routes
Special Areas
Buoys and Beacons
Topmarks
Colour Test Diagram
Approved New Object Symbols
Overview

Datum Transformation

(Geodetic Datum)
From
To
(Reference Position)
Position
Ship Position
by Cursor
(Chart Shift)
Reference Position
[Position]
Shifted Position
[Position]
OK
Cancel

Check Applied C-MAP Updates

Chart List
Show

Show C-MAP Licence Information

B.1.6 User Chart

ECDIS

File Operation

- New
- Delete
- Copy
- Import
- Export
- Merge Display Files
- Geodetic
- (File List)
- Edit User Chart
- Display Objects

Mark/Line List

- User Chart tab
 - Symbol
 - Line
 - Area
 - Text
 - Delete
 - Page feed button
 - Page number specification
 - Object list
 - Jump
- Mariner's Mark/Line tab
 - Event Mark
 - Information Mark
 - Tidal Stream
 - Highlight
 - Clearing Line
 - Delete
 - All Delete
 - Page feed button
 - Page number specification
 - Object list
 - Jump
- Manual Update tab
 - Symbol
 - Line
 - Area
 - Text
 - Hide
 - Restore
 - Chart Type
 - Page feed button
 - Page number specification
 - Object list
 - Jump

Delete by type/color

- Type
- Color
- OK

B.1.7 Logbook

Date

Calendar Icon

Event

Event List (Event List)

User Task Log tab
[No.]
[Date(LMT)]
[Event]
Navigation Alert Log tab
[No.]
[Date(LMT)]
[Event]
System Alert Log tab
[No.]
[Date(LMT)]
[Event]

Event details page (Event detail information)

Event
Date
Time Zone
Descriptions
(Position)
[Longitude]
[Latitude]
[POSN1]
[POSN2]
(Course/Speed)
[HDG]
[STW]
[COG]
[SOG]
[SOG-Av.(4h)]
[SOG-Av.(24h)]
Depth
Chart
INFO
(Current)
[Set]
[Drift]
(Wind)
[Dir.]
[SPD]
[BFT]
(Wave)
[Dir.]
[Height]
(Voyage Distance)
[(Ground)]
[(Water)]
(Weather)
[Air Pressure]
[Air Temperature]
[Water Temperature]
[Weather Condition]
Engine Rev.
Comment

B.1.8 TT/AIS

ECDIS

AIS Voyage Data

- Destination
- ETA(UTC)
- Calendar Icon
- NAV Status
- Draft
- Cargo cat.
- Persons on-board
- Send

Edit and Send AIS Message

- (Send To:)
 - Addressed MMSI
 - Name
 - Target ID
 - Broadcast
- Category
- LL&Time
- View Tray
- Message
- Save
- Send

AIS Message - AIS MSG Tray: Same as the common information window (AIS MSG Tray of the information reference screen)

- Tray Select
- Message Format:
- Message Category:
- Message List
- MMSI
- Ship's Name
- AIS Message
- Edit
- Select

Highlighting

- Highlighting by the following search criteria
 - (TT/AIS)
 - Transit direction
 - TCPA(MIN-MAX)
 - TCPA MIN
 - TCPA MAX
 - CPA(MIN- MAX)
 - CPA MIN
 - CPA MAX
 - SOG(MIN- MAX)
 - SOG MIN
 - SOG MAX
 - Unknown Ship
 - (AIS)
 - Length MIN- MAX
 - Type of Ship
 - Cargo category
 - Registry of ship
 - Navigation Status

TT/AIS List: Same as the TT/AIS list of the common information window (information monitoring screen)

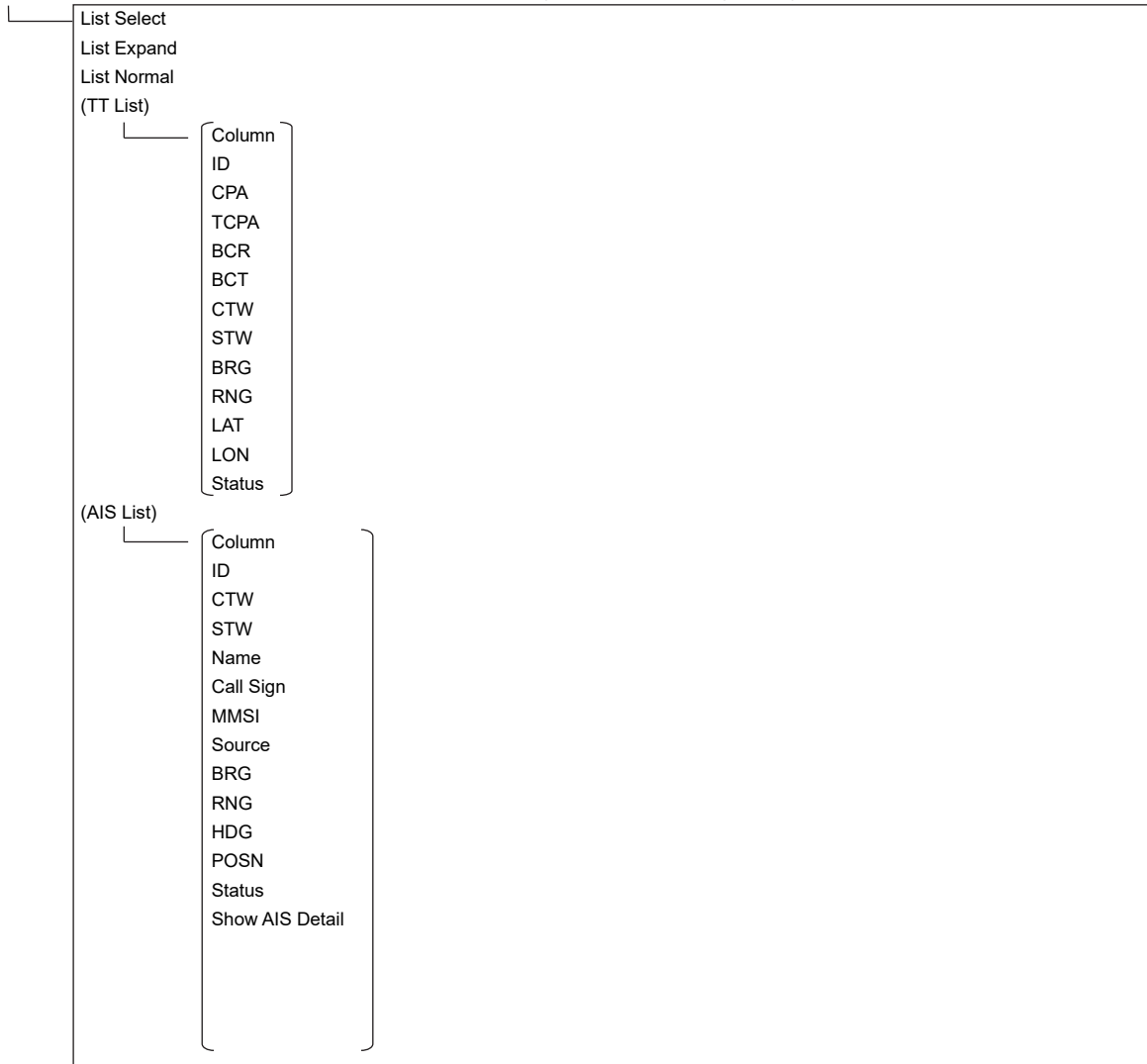

Own Ship AIS Data: Same as AIS of the common information window (information reference screen)

- Own Ship AIS Data/Last Lost AIS Target
 - Name
 - Call Sign
 - MMSI
 - IMO No.
 - Length
 - Beam
 - Destination
 - ETA(UTC)
 - Navigation Status
 - Draft
 - Type of Ship
 - Cargo category
 - Persons on-board
 - CTW
 - STW
 - Heading
 - ROT
 - Position
 - Position Accuracy
 - Position Sensor

Last Lost AIS Target: Same as AIS of the common information window (information reference screen)

- Own Ship AIS Data/Last Lost AIS Target
 - Name
 - Call Sign
 - MMSI
 - IMO No.
 - Length
 - Beam
 - Destination
 - ETA(UTC)
 - Navigation Status
 - Draft
 - Type of Ship
 - Cargo category
 - Bearing
 - Range
 - CTW
 - STW
 - Heading
 - ROT
 - Position
 - Position Accuracy
 - Position Sensor
 - Source

B.1.9 Tools

ECDIS

Marker

- Position
- Bearing
- Range
- Unit switching button
- TTG
- Time

EBL/VRM readout

- EBL1
- VRM1
- EBL2
- VRM2
- Origin Position of EBL1/VRM1
- Origin Position of EBL2/VRM2
- EBL Bearing Reference
- VRM Distance Unit
- Control Indication

PI Menu

- Display for All Lines
- Mode
- (All)
- PI Bearing
- Interval
- Unit switching button
- Operation Area
- (Individual)
- Index Line
- Display
- PI Bearing
- Interval
- Unit switching button
- Length L
- Length R
- Unit switching button
- Sequential
- (Track)
- Group
- Display
- PI Bearing
- Interval
- Unit switching button
- (Equiangular)
- Group
- Display
- PI Bearing
- Vertical Angle
- Floating
- Heading Link
- Reference Bearing

EBL Maneuver Setting

- Display Maneuver curve
- Course T
- Course R
- Reach
- (Turning set)
 - Radius
 - Rate
- DWOL
- TWOL

Manual position fix

LOPs Fixing tab

- LOP
 - Total, MAX
 - (Observations Time)
 - Date
 - Calender Icon
 - Time (UTC)
 - Position(e.g. landmark)
 - Bearing
 - Distance
 - Transfer Position Line
 - HDG/STW
 - COG/SOG
 - HDG
 - STW
 - Set
 - Drift
 - Set
 - Delete
 - Plot
 - Set plotted position → [Select LOP or TPL] dialog box
 - Offset to plotted POSN(Main)
 - Offset to plotted POSN(Sub)
 - Plot by cursor
 - Clear all lines

Position Offset tab

- (POSN(Main))
 - Offset
 - Clear Offset
 - Enter Offset
 - Enter Position
- (POSN(Sub))
 - Offset
 - Clear Offset
 - Enter Offset → [Enter Offset] dialog box
 - Enter Position → [Enter Position] dialog box

Node Fixed EBL/VRM

- Use node fixed EBL/VRM
- Bearing
- Distance

Cursor readout

- BRG
- RNG
- POS
- TTG
- ETA

File Manager

- File Management tab
 - File Type
 - Drive
 - Name
 - Copy >>
 - << Copy
 - Select All
 - Delete
- File Load/Save tab
 - File Type
 - File Type (Included GPS Buoy Track)*
 - *Setting for using [Utilities] - [GPS Buoy] when [File Type] is [Target Track]
 - File List - Name
 - File List - Modified
 - File List - Display
 - Load Mode
 - Load
 - Unload
 - Save Current Target Track

VHF Call

* Case where the VHF radiotelephone option is attached

* In case of JAN-7201S/9201S, the function is not available by function restriction.

- VHF (JHS-800S) 1
- VHF (JHS-800S) 2
- VHF (JHS-800S) 3

Timer

- (Timer)
- (LMT)

B.1.10 View

View-Multi View Mode

- └─ Multi View Mode
 - └─ View selection
 - └─ Select Area from View1 for View2

View-Options

- └─ Own Ship
 - └─ Type
 - Heading and Beam Line (Vector)
 - └─ Ground stabilised vector
 - └─ Sea stabilised vector
 - └─ Time
 - └─ Stabilisation indicator
 - └─ Vector Time Mark
 - └─ Interval
 - POS2 Symbol
 - Setting of AIS Filter
 - Setting of AZ
 - Setting of Anti-Grounding Look-ahead

Own Track

* Selecting [ECDIS own Track] on the Utilities menu

- └─ Past Track
 - Plot Color
 - Track Period
 - Time Label
 - Interval
 - Past Position
 - Interval
 - Current Vector
 - Current Size
 - Interval

Route

For ECDIS

* Selecting ECDIS Route on the Utilities menu.

- └─ (Date/Time for Monitoring)
 - Format
 - Show ETA
 - XTD Limit Line
 - Color
 - Show WPT Name
 - WPT Name Font Size
 - Alterate Route

User Chart

- └─ (Object Type)
 - (Selecting Individual)
 - └─ Symbol
 - └─ Line
 - └─ Area
 - └─ Text
 - Area Fill
 - Symbol/Simple Line Color
 - Mark Size
 - Comment Font Size

Mariner's Mark/Line

- └─ Clearing Line
- Tidal Stream
- Information Mark
- Highlighting
- Event Mark
- Plotted position
- NAVTEX Mark

RADAR

- RADAR Overlay
 - Transparency of Echo/Trails
- * In case of JAN-7201S/9201S, the function is not available by function restriction.

Target

- AIS Symbol
 - (Selecting AIS Symbol)
 - Physical AtoN
 - Virtual AtoN
- TT1 Symbol
- TT1 Symbol Source Selection
- TT2 Symbol
- TT2 Symbol Source Selection
- TT Vector
- TT Target ID
- AIS Target ID

Target Track

- Display tab
 - (Target Track Display)
 - (Selecting Individual)
 - Track 1
 - Track 2
 - Track 3
 - Track 4
 - Track 5
 - Track 6
 - Track 7
 - Track 8
 - Track 9
 - Track 10
 - Track 11 to 20
 - File Load/Save
- Plot tab
 - (Plot Color)
 - For All Target Track
 - For individual Target Track
 - Track 1
 - Track 2
 - Track 3
 - Track 4
 - Track 5
 - Track 6
 - Track 7
 - Track 8
 - Track 9
 - Track 10
 - Track 11 to 20
 - Plot Interval
 - File Load/Save
- Clear tab
 - (Clear by Specified Color)
 - Track Color
 - (Clear by Specified Number)
 - Track Number

Chart Common

- Area Boundary
- Chart Symbol
 - Full Light Lines
 - Consider Scale Minimum
- (Depth)
 - Shallow Contour
 - Safety Depth
 - Safety Contour
 - Deep Contour
 - Four Shades
 - Shallow Pattern
 - Shallow Water Dangers
- C-MAP Ed.3 Database

Chart Display

- View1 tab
 - Chart Type
 - Chart Load
 - Text Size
 - Readout undisplayed chart object
 - Group Layer
 - Layer
 - Text
- View2 tab
 - Chart Type
 - Chart Load
 - Text Size
 - Readout undisplayed chart object
 - Group Layer
 - Layer
 - Text

AIO

- All AIO Objects
- Temporary Notice(T)
- Preliminary Notice(P)
- ENC Preliminary Notice(EP)
- No Information Objects

Graphical Indication

- Graphical Indication for the Charted Feature Object
- Crossing Safety Contour
- Navigational Hazards
- Prohibited Areas and Areas with Special Conditions
- Settings for Depth/Safety Contour
- Settings for Look-ahead
- Settings for Are Alert

Tools

- Range Rings
- Bearing Scale
- EBL1
- EBL2
- VRM1
- VRM2
- PI
- Index Line 1
- Index Line 2
- Index Line 3
- Index Line 4
- Index Line 5
- Index Line 6
- Index Line 7
- Index Line 8
- Node Fixed EBL/VRM

Unit ECDIS CONNING

- Depth(Included depth in Chart)
- Current Speed
- Wind Speed
- Propeller Revolution
- Propeller Pitch Angle
- Thruster Revolution
- Thruster Pitch Angle
- Air TEMP
- Water TEMP
- XTD for TCS Info CONNING
- Air Pressure
- Wind Direction(True)

In case of JAN-7201S/9201S, the function is not available by function restriction.

Control

- (Top Level Screen Information on ECDIS) *
- * Group box units
 - Show Sub Information Window
 - Watch(Vector / RADAR / Target status)
 - POSN DIFF(Difference between POSN(Main) and POSN(Sub))
- Depth
- Current

Tooltips/Infotips

- Tooltips
- Mouse Over Information

Depth Graph *

* Case where the depth sensor is connected.

- (Depth Trend Graph)
 - Depth Range(Docking) CONNING
 - Depth Range(Voyage)
 - Time Range
 - Reference

Rudder Graph

* Case where the gyro and rudder is connected.

(Rudder Trend Graph) [Time Range] [Rudder Range]
--

Gyro/Rudder Graph *

* Case where the depth sensor is connected.

(Gyro/Rudder Trend Graph) [Time Range] [Rudder Range]

Engine Graph *

* Case where the engine is connected.

(Engine REV Trend Graph) [Time Range] Maximum rpm [Minimum rpm]
--

Wind Graph

(Wind Speed Trend Graph) [Time Range] (Wind Direction Trend Graph) [Time Tange]
--

Sea TEMP

(Sea TEMP Trend Graph) [Time Range]
--

ROT

(ROT) [ROT Scale]

B.1.11 Alert

ECDIS

RADAR

New Target Warning ECDIS

- Use AZ 1
- Use AZ 2
- 1 tab
 - Make AZ1 ⇒ Change to the AZ1 range setting mode
 - Start Angle
 - End Angle
 - Start Distance
 - End Distance
- 2 tab
 - Make AZ 2 ⇒ Change to the AZ2 range setting mode
 - Start Angle
 - End Angle
 - Start Distance
 - End Distance

Depth/Safety Contour ECDIS

- (Crossing Safety Contour Alarm)
- Shallow Contour
- Safety Depth
- Safety Contour
- Deep Contour
- View Settings for Chart Common

Look-ahead ECDIS

- (Area(Rectangle))
 - Use Area(Rectangle)
 - Length
 - Width
- (Area(Sector))
 - Use Area(Sector)
 - Radius
 - Width

Special Condition Area ECDIS

- Special Condition Area
- Alert Priority

Track Control ECDIS

- (Course difference warning) *
- [Course difference limit]
- (End of track warning) *
- [End of track limit]
- (Early course change warning) *
- [ECC limit]
- * Case where [Show Alert On/Off for Track Control] on the utilities menu is set to [On].

In case of JAN-7201S/9201S, the function is not available by function restriction.

Position Integrity

- (POSN(Deviation) Integrity)
- POSN Discrepancy Limit
- (POSN(Jump) Integrity)
 - Radius Limit (GPS)
 - Radius Limit (DGPS)
 - Time Limit
- (HDOP exceeded)
- HDOP Limit

AMS

- (Reactivation of Silenced Alert)
 - Category A/B Time Limit
 - Category C Time Limit
- (Transfer to BNWAS)
- Time Limit
- (Repetition of UNACK Warning)
- Time Limit
- (Responsibility Transfer)
- Display On

In case of JAN-7201S/9201S, the function is not available by function restriction

B.1.12 Settings

ECDIS

CONNING

Signal Process(Basic) ECDIS *

* Case where the radar is connected

- Gain
- Sea
- Rain
- IR
- Target Enhance
- Echo Process

Signal Process ECDIS

* Case where the radar is connected

- Video Latitude
- Video Noise Rejection
- Auto Dynamic Range Control
- (Process Switch)
 - Process Switch
 - 2nd Process Mode *
 - * Case where [Process Switch] is set to [Off]
 - Process Switch Range *
 - * Case where [Process Switch] is set to [Range Fix]
- Fast Target Detection

Association ECDIS

- Association
- TT/AIS Priority *
- TT1/TT2 Priority *
 - * Case where [Association] is set to [On]

Ship's Dynamic Trait ECDIS

- Reach
- Turning Mode
- (Turning Set)
 - Radius
 - Rate
- Acceleration
- Deceleration

Filter ECDIS

- Sector Filter
- Start Angle
- End Angle
- Ring Filter
- Distance
- Filtering Mode
- Sector tab
 - Make AIS Filter
 - Start Angle *
 - End Angle *
 - * Case where [Make AIS Filter] is set to [On]
- Ring tab
 - Make AIS Filter
 - Distance *
 - * Case where [Make AIS Filter] is set to [On]

Target Track ECDIS

Target Track Function
View for Target Track
File Load/Save

Route

(For ECDIS route) ECDIS
(Default)
XTD(PORT)
XTD(STBD)
Arrival radius
Speed
Sail
Turning Radius
Time zone
Distance calculation mode
Monitoring
MAX Latitude
Minimum Leg Length for Limit Check

Autosail * ECDIS

* Case where the autopilot option is attached

Turning Gain *
* Displayed when the autopilot is in the following case.
- Tokyo Keiki TCS Category C
- Tokyo Keiki TCS Category B (new model)
Tracking Gain **
Drift Correction **
Dead Band **
Alert for Track Control
** Displayed when the autopilot is in the following case.
- Tokyo Keiki TCS Category B (old model)
- YDK TCS Category C
- YDK TCS Category B
- All types of autosailing

In case of JAN-7201S/9201S, the function is not available by function restriction.

Temporary Route ECDIS

Pre Run Speed
Pre Run Time
Pre Run Distance
Enter Angle
Turning Radius
XTD MAX
Course Difference Limit

Chart ECDIS

(Redraw)
Border Range
Margin(Chart Rotation)
AUTO Accepting S-57 Updated Chart
Deletion Mode(Chart Maintenance)

Logbook ECDIS

Logging Events tab

- At noon
- Every
- Event Mark
- Manual Position Fix
- Chart Manual Updating
- System Start
- System Exit
- Route Alert
- Chart Alert
- Autosail Alert
- System Alert
- MOB Start/Stop

View Filter tab

- At noon
- Specified Period
- Event Mark
- Manual Position Fix
- Chart Manual Updating
- System Start
- System Exit
- Route Alert
- Chart Alert
- Autosail Alert
- System Alert
- Latest Display Days

NAVTEX ECDIS

(Highlighting of Message List)

- Navigational Alarm
- Weather Alarm
- Ice Warning
- Search and Rescue Information
- Extended Navigational Information

Display Filtering for NAVTEX Messages

General ECDIS

(Gyro I/F)*

- GYRO Setting
- * Gyro I/F is equipped.

Color and Brightness

Day/Night
Def.
Display Color tab
OuterPPI */Dialog
InnerPPI *
Character
RADAR Video *
* Under radar connection
Target Symbol *
* Displayed at the equipment setting for receiving TT information
Range Rings *
* Under radar connection
EBL1/VRM1/PI
EBL2/VRM2
Own Symbol/HL/Vector
Brightness tab
Character
RADAR Video *
* Under radar connection
Target Symbol *
* Displayed at the equipment setting for receiving TT information
Range Rings *
* Under radar connection
EBL/VRM/PI
Own Symbol/HL/Vector
Panel
Day1 : Level4 / Day2 : Level3 / Day3 : Level2 / Dusk,Night : Level1
Display
<26 inch>[0~100]Day1/Day2/Day3 : 67 / Dusk : 60 / Night : 11
<19 inch> Day1/Day2/Day3 : 42 / Dusk : 20 / Night : 4

Sounds

Volume tab
Key ACK
Misoperation
Response/Notification
Message Notification
Alert Setting Reminder
Alarm
Warning
Melody tab
Alarm
Warning

Key Assignment

User Keys tab *

- * Under the connection of the optional operation unit

DISP Off Key

User Key 1

User Key 2

Multi Dial tab

- Vector Time
- C UP Angle
- Own Track Color
- Display Brightness
- Panel Brightness
- Gain *
- Sea *
- Rain *
- * Under radar connection

AZ Key tab * ECDIS

- * Under the connection of the optional unit and radar

AZ 1

AZ 2

Preferences ECDIS

Name

Save *

- * Disable is displayed when up to the maximum private settings are saved.

Load *

- * Disable is displayed when no item is selected in the name list.

Delete *

- * Disable is displayed when no item is selected in the name list.

Default display configurations

Screen capture ECDIS

AUTO Capture Interval

AUTO File Erase

- * Disable is displayed when [AUTO Capture Interval] is set to [0].

File Management

B.1.13 Chart Maintenance

ECDIS

Import/Update Licence file

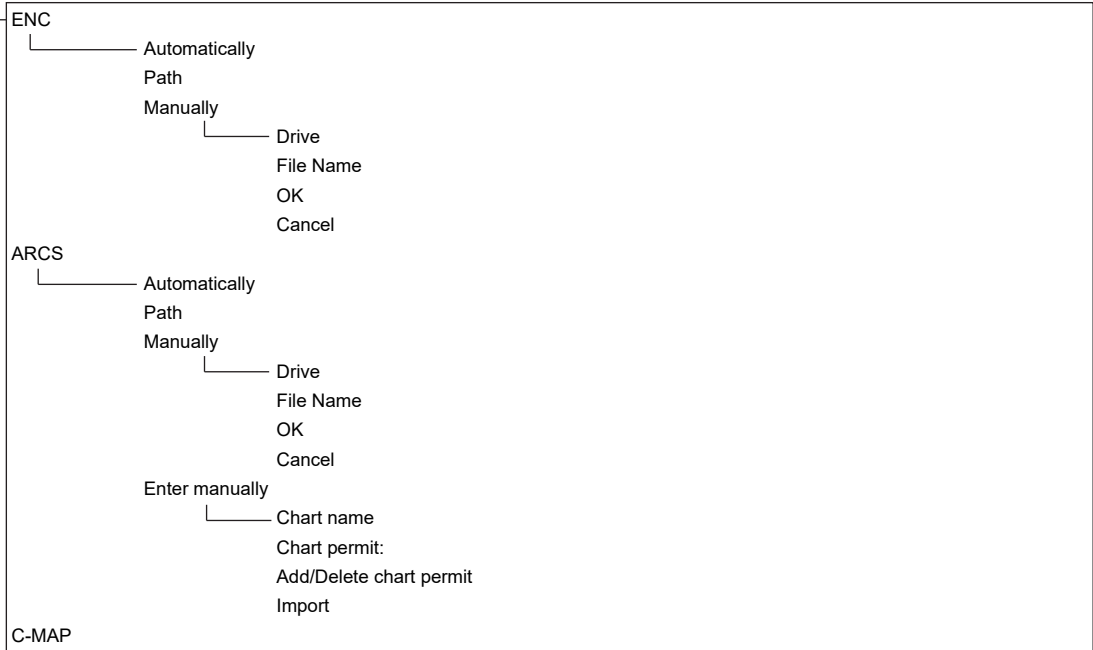

Import/Update charts

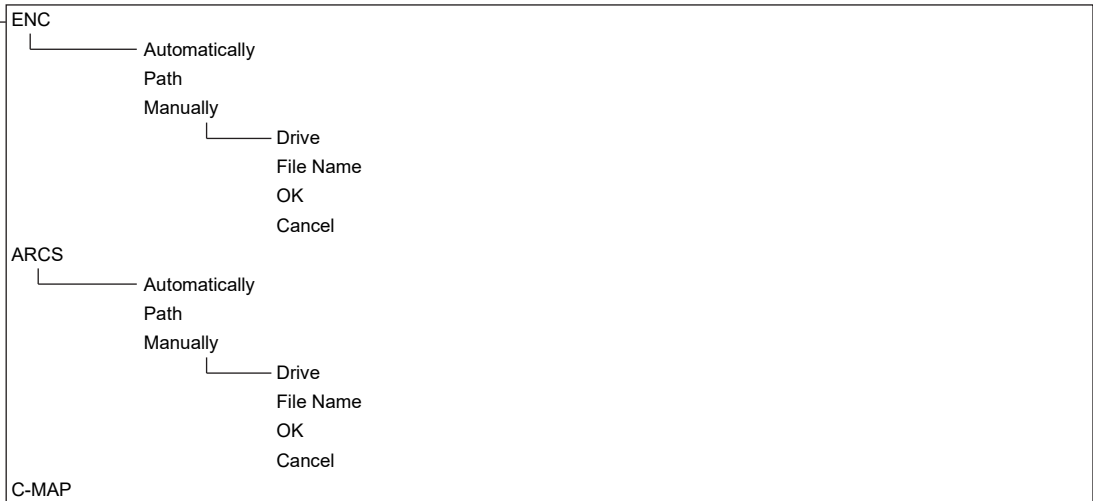

Check Status

Status List tab

- Delete
- (Chart list)
- Cell Name
- Cell Ver.
- Issue Date
- Weekly No
- Last Update
- Expiry Date
- Accepted
- Rejected
- DS_ID
- Scale
- (Licence information)
- S-63 User permit
- S-63 Cell permit
- (SA certificate)
- SA certificate file
- Data Server
- Load new SA certificate
- (Licence Information)
- ARCS User Permit
- ARCS Chart Permit
- Licence e
- Vessel Name
- Fixed Site #1
- Host Name
- Licence Type
- (Cell Information)

Log tab

- Log
- Import/Update Charts
- Import/Update Licence

B.1.14 Maintenance

ECDIS

CONNING

Date/Time/Time Zone

- (Date)
 - Month
 - Year
 - Day
- Time(LMT)
- Time Zone
- Display Style
- Synchronise with Time Source(Date/Time)
- Synchronise with Time Source(Time Zone)

System Information

- Software tab
 - Type
 - Application
 - Maintenance No.
 - TXRX
 - TCS
 - Presentation Library
 - BAMS
- Functionality tab
 - Device Licence Status
 - Option Licence Status
- H/W Key tab
 - (ARCS Information)
 - PIN
 - User Permit
 - (S-63 Information)
 - User Permit
- Specification tab
 - Specifications

Save to USB Device

Operating Time

- (Operating Time of Work Station)
 - Total
 - SSD1
 - SSD2
 - LCD
 - LCD FAN
 - CCU FAN
 - PSU FAN
- (Operating Time of Scanner)*
 - * Under radar connection
 - Total
 - Transmit
 - Motor
 - FAN

Voyage Distance

- (Current Voyage Distance)
 - Ground
 - Water
 - Clear

Sensor Selection/Status

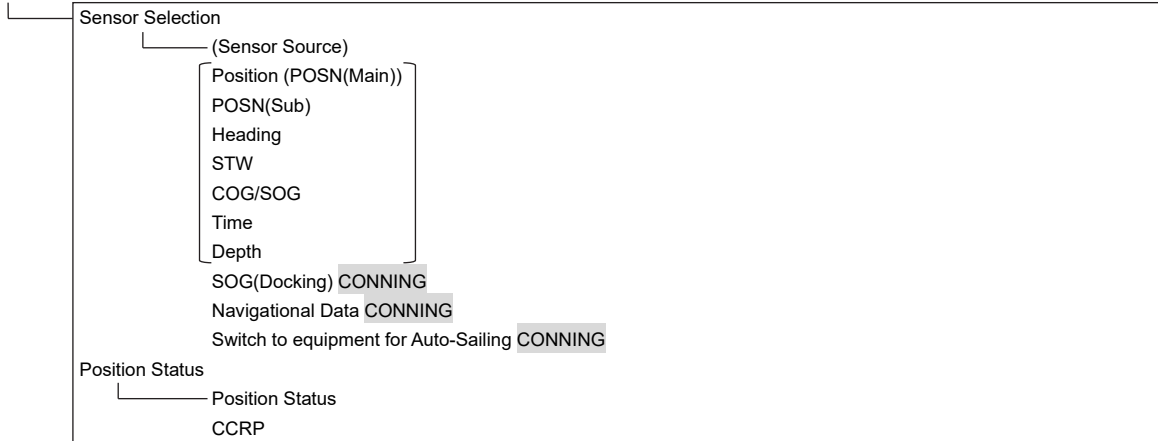

Inmarsat-C DNID(for LRIT)



Diagnosis

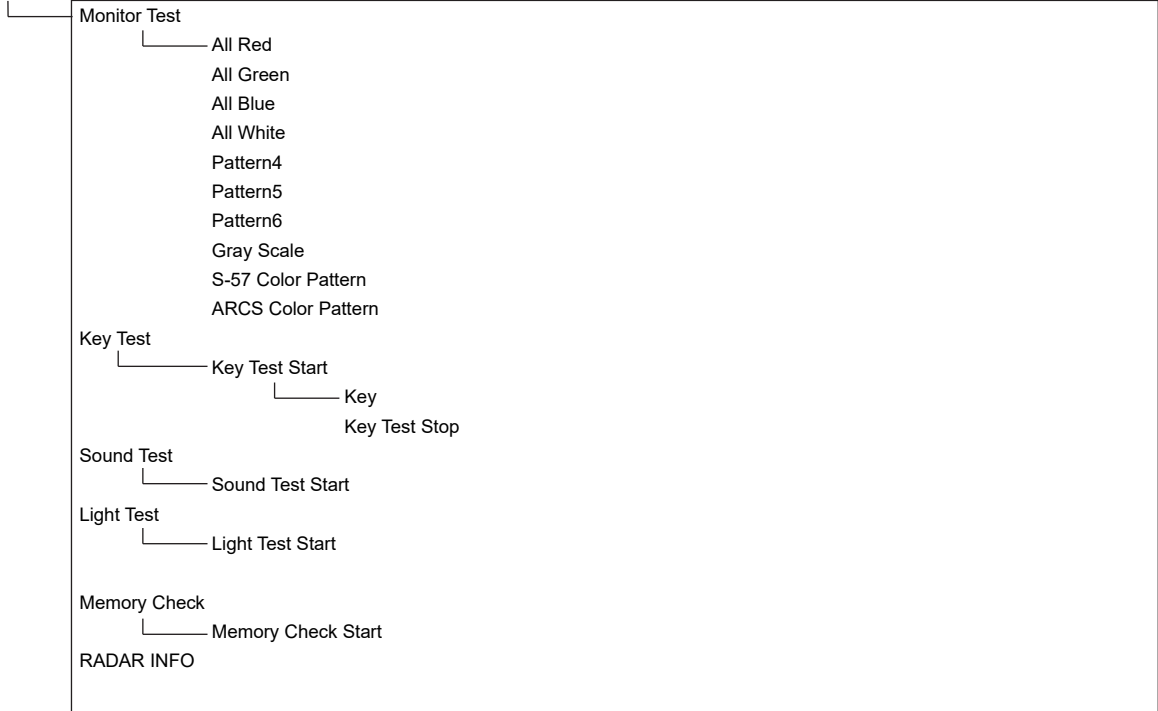

Software Update



DVD Drive Cleaning

Maintenance INFO

B.1.15 Help

ECDIS

CONNING

←

→

Home

(Contents tab)

(Search tab)

[keyword]
[Search]
[Results]

B.1.16 Code Input

ECDIS

CONNING

Password

B.1.17 Service

ECDIS

CONNING

Adjustment ECDIS

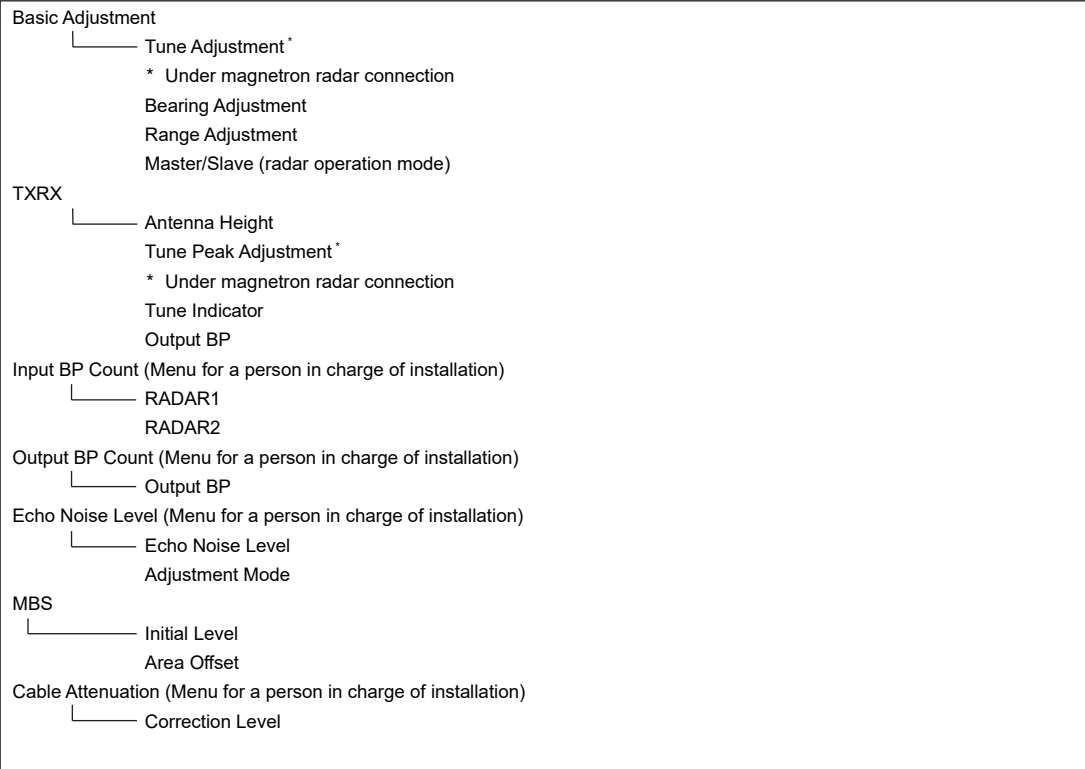

Installation

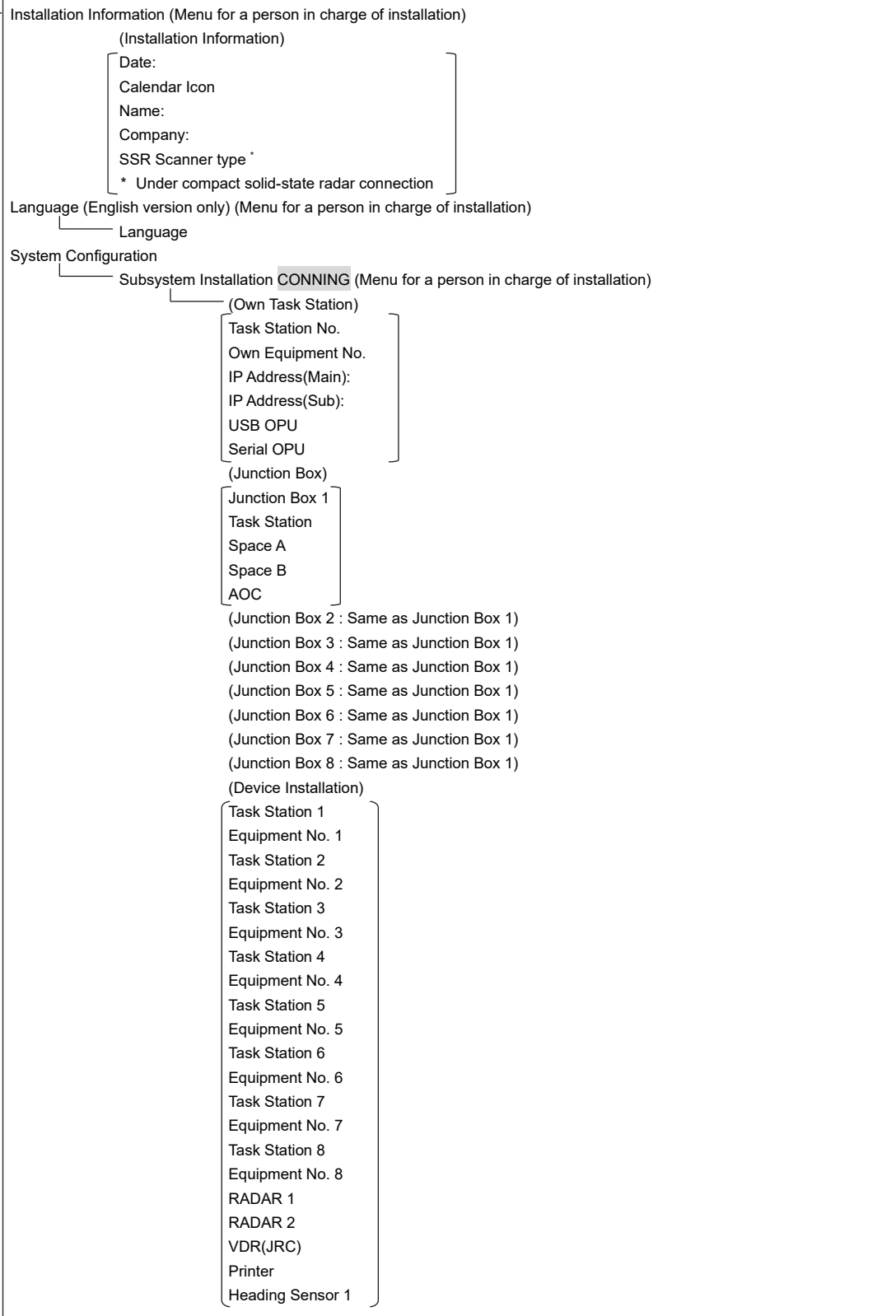

Heading Sensor 2
 Heading Sensor 2(Type)
 Log 1
 Log 1 Interface/Type
 Log 2
 Log 2 Interface/Type
 GPS 1
 GPS 2
 GPS 3
 GPS 4
 Ship's Clock
 Echo Sounder 1
 Transducer 1
 Transducer 2
 Echo Sounder 2
 Transducer 3
 AIS
 NAVTEX
 Anemometer
 Water TMP Meter
 Current Meter
 Climate Meter
 ROT Indicator
 Autopilot
 Autopilot Type
 Rudder
 Rudder Number
 Engine/Propeller
 Engine/Propeller Number
 Engine Telegraph
 Engine Telegraph Number
 Bow Thruster
 Bow Thruster Number
 Stern Thruster
 Stern Thruster Number
 Azimuth Thruster
 Azimuth Thruster Number
 Generator
 Generator Number
 S-JOY1
 S-JOY2
 S-JOY3
 S-JOY4
 S-JOY5
 GPS Selector
 Log Selector
 Inmarsat-C 1
 Inmarsat-C 2
 BNWAS
 BNWAS Type
 General Equipment(Alert)
 General Equipment(Alert) Number
 GPS Buoy
 Plotter
 VHF (JHS-800S) 1*
 VHF (JHS-800S) 2*
 VHF (JHS-800S) 3*
 Hull Motion
 Set

* In case of JAN-7201S/9201S,
the function is not available by function restriction.

- CCRP
 - Length
 - Beam
 - GPS1 X~GPS4 X
 - GPS1 Y~GPS4 Y
 - RADAR Antenna1 X~RADAR Antenna8 X
 - RADAR Antenna1 Y~RADAR Antenna8 Y
 - CCRP1 X~CCRP4 X
 - CCRP1 Y~CCRP4 Y
 - (Speed Position(from fore Draft))
 - [Bow]
 - [Stern]
- Serial Port
 - (CCU)
 - [Gyro/Log/GPS/AIS]
 - Sensor
 - Selftest
 - Detail → [Serial Port-Detail] dialog box
 - Monitor → [Serial Port-Monitor] dialog box
 - [ISW/MTR/Serial OPU]
 - Diagnosis
 - Monitor → [Serial Port-Monitor] dialog box
 - SLC1(M) tab
 - [CH1 ~ CH8]
 - [CH9 ~ CH10]
 - [Gyro I/F]
 - Sensor
 - Selftest
 - Detail → [Serial Port-Detail] dialog box
 - Monitor → [Serial Port-Monitor] dialog box
 - (SLC2(M)~SLC4(M) : SAME AS SLC1(M))
 - (SLC2(S)~SLC4(S) : SAME AS SLC1(M))
 - (ALC1~ALC4 : SAME AS SLC1(M))
- System Function
 - Equipment
 - Connection
 - System Function
 - SFI Talker
 - SFI No.
 - Cluster
 - Control Tx
 - Alert Tx
 - Alert Rx
 - Delete
 - Add → [System Function(Add)] dialog box
 - Edit → [System Function(Edit)] dialog box

Contact (Menu for a person in charge of installation)

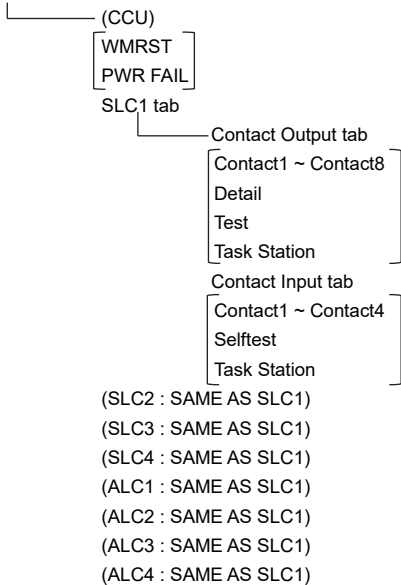

Data Output (Menu for person in charge of installation)

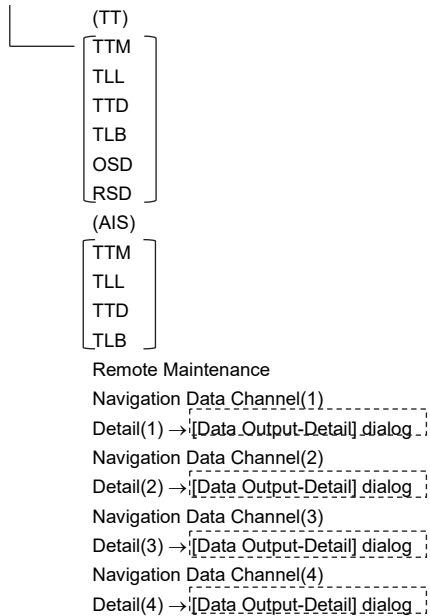

Network (Menu for person in charge of installation)

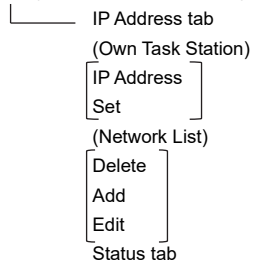

Redundancy (Menu for person in charge of installation)

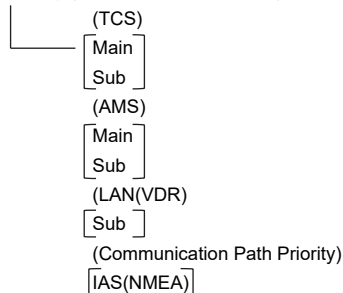

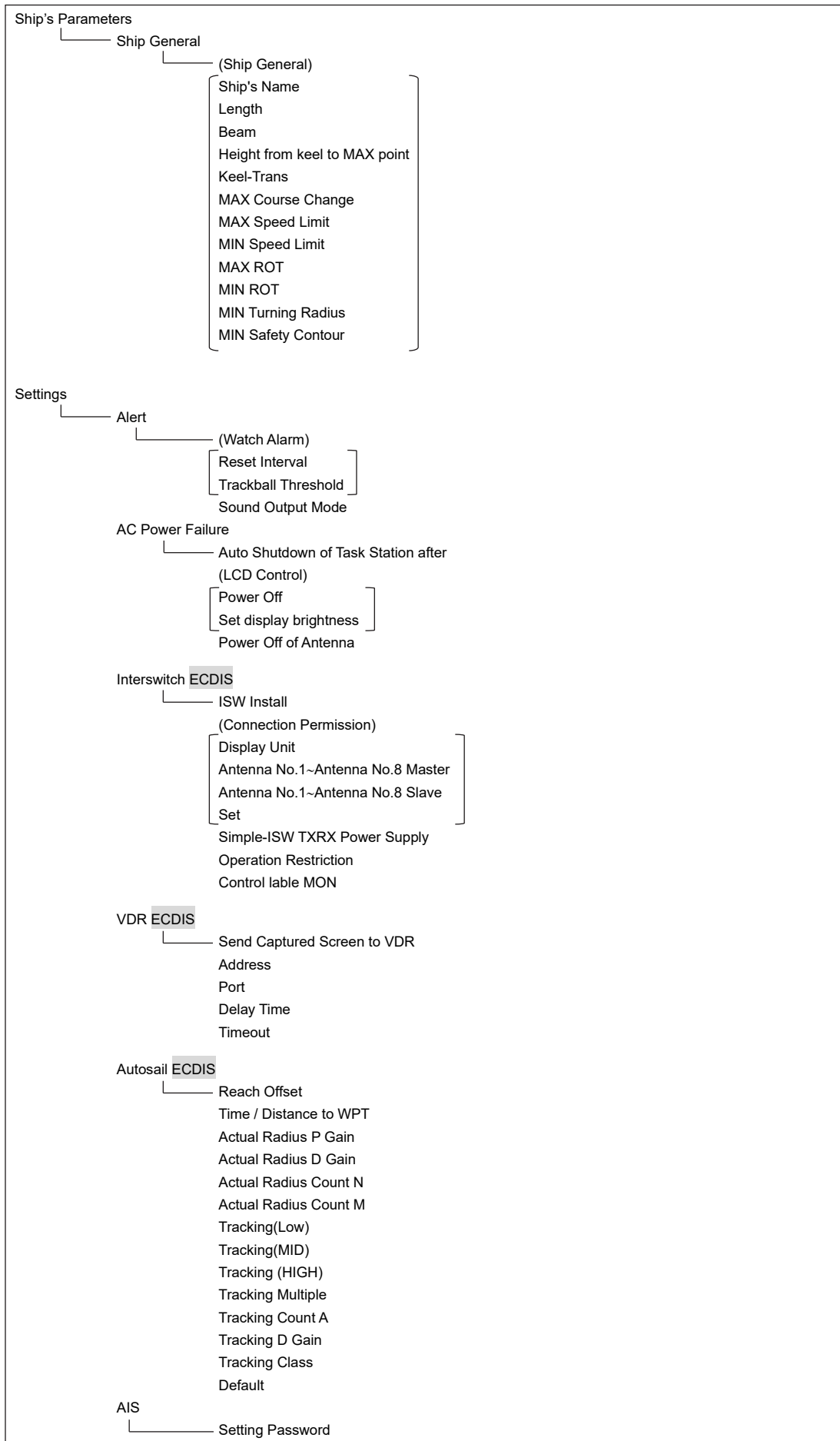

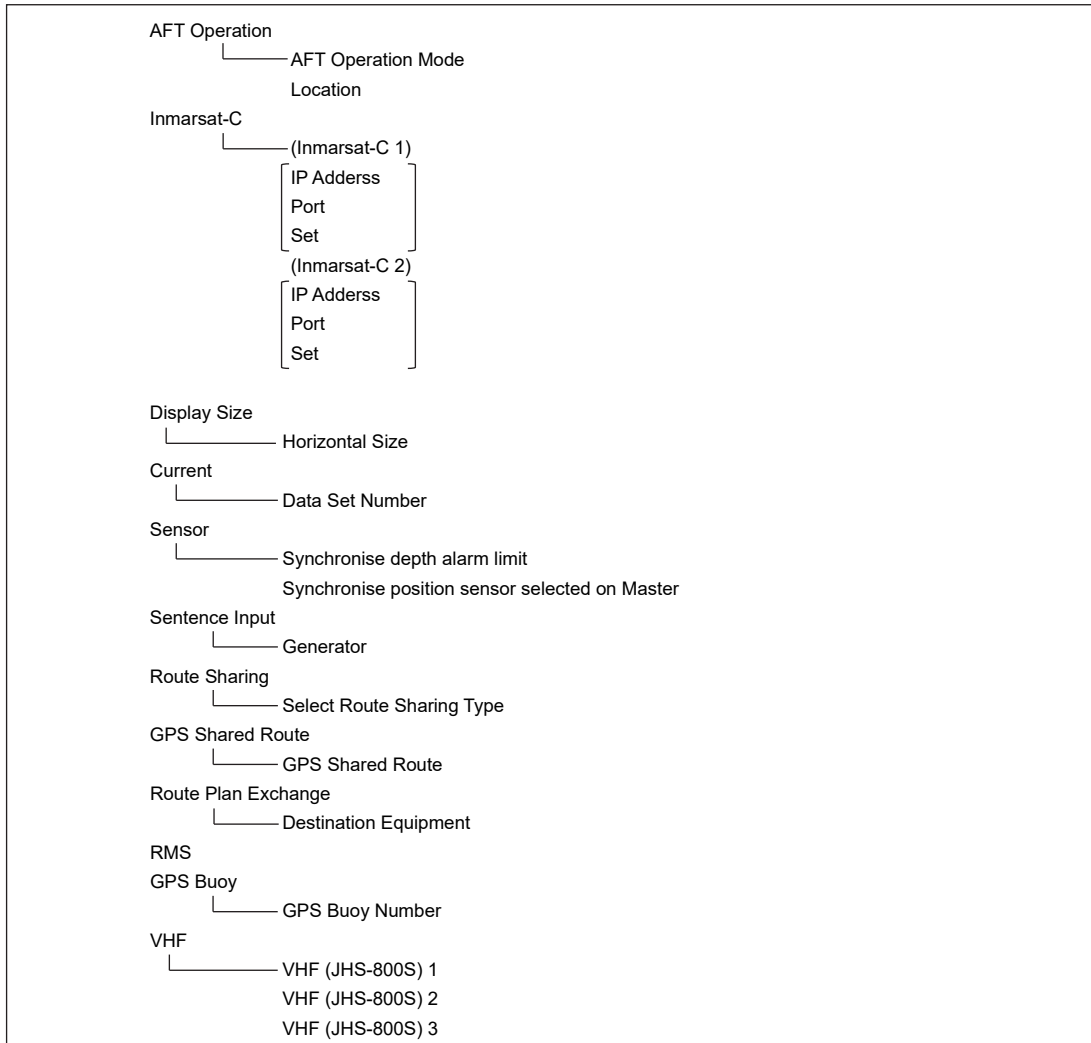

Maintenance

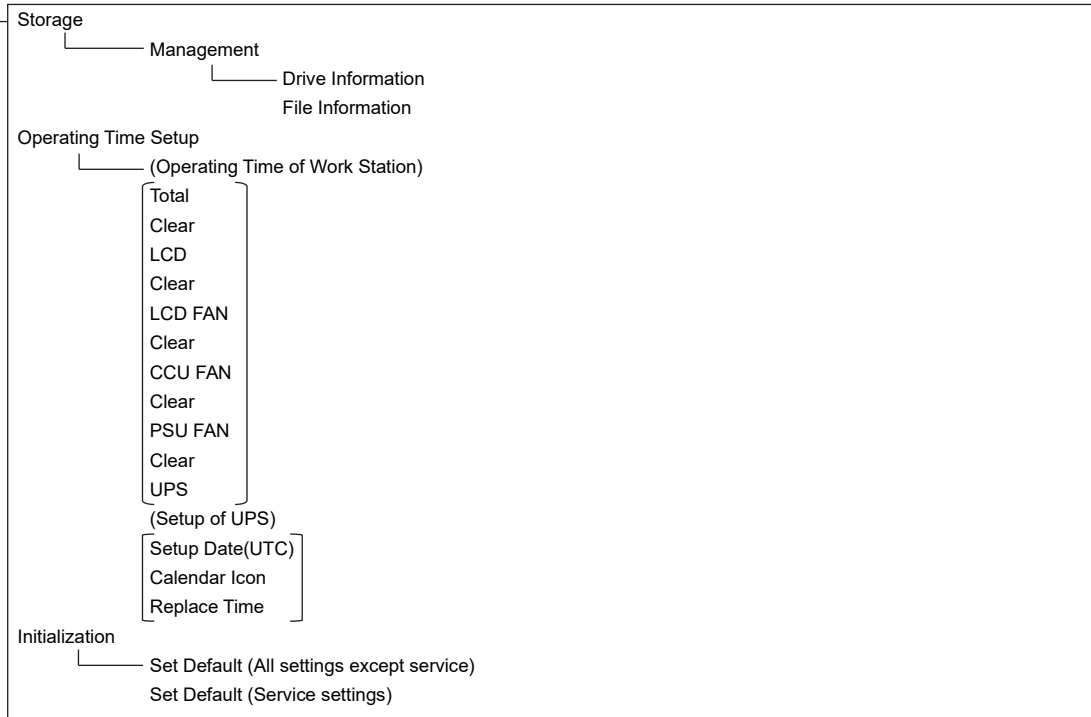

B.2 Context Menu List

This section shows the context menus that are displayed by clicking the right button by target object.

* The items that are enclosed by the frame of broken lines indicate the dialogs and windows that are displayed by selecting the relevant menu.

B.2.1 No object

B.2.1.1 ECDIS (S57/C-MAP) screen

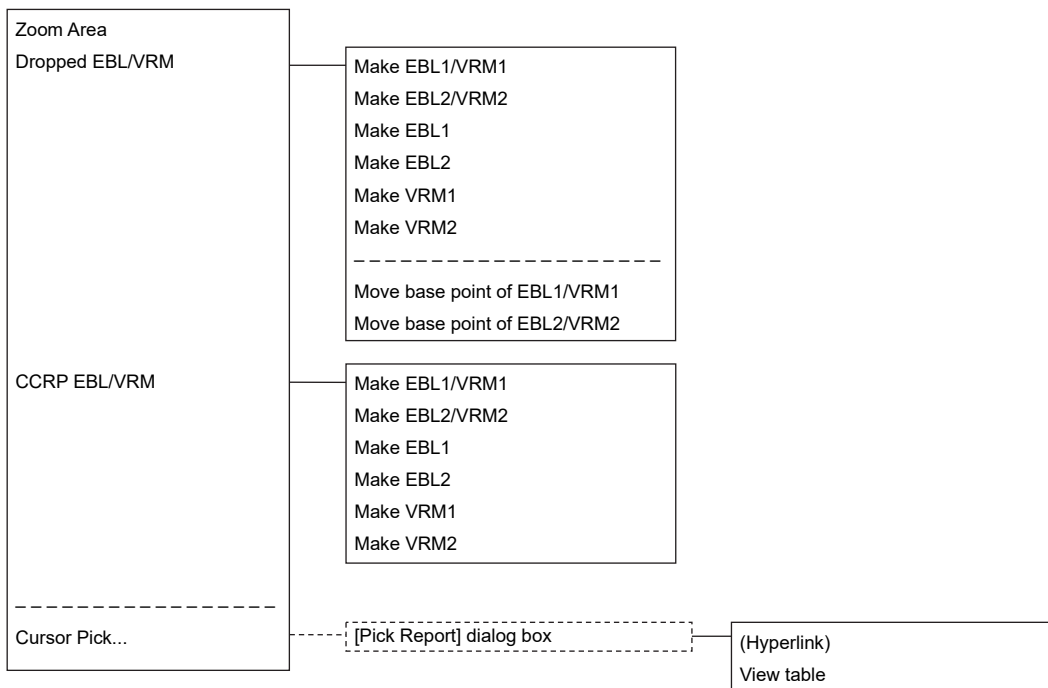

B.2.1.2 ECDIS(ARCS) screen

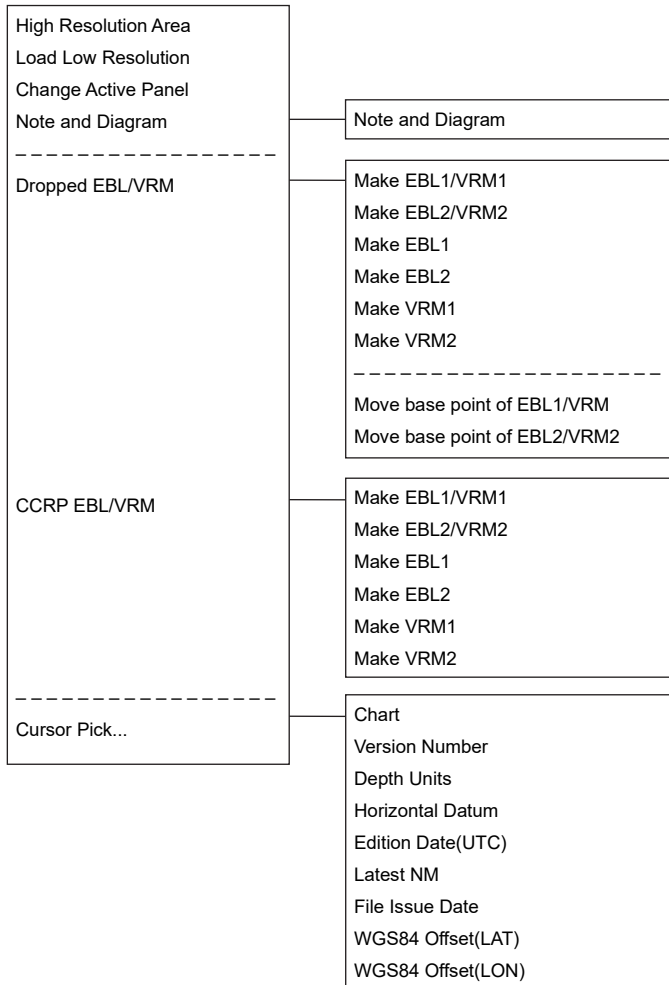

B.2.2 AIS

B.2.2.1 Sleeping AIS target

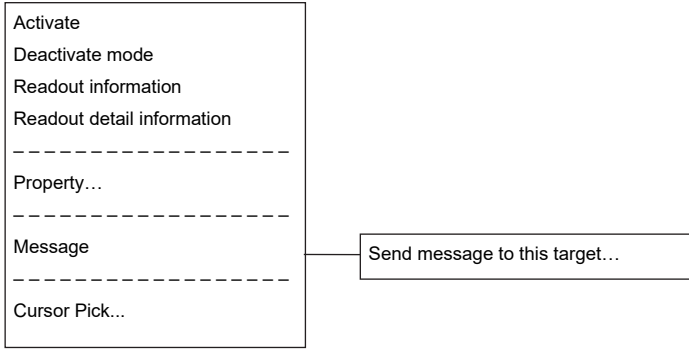

B.2.2.2 Activated AIS target

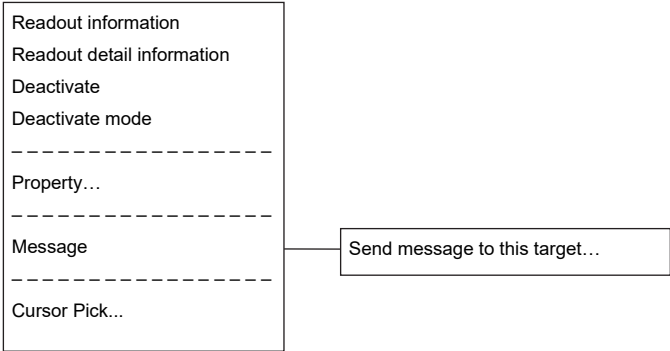

B.2.2.3 Numeric displayed AIS target

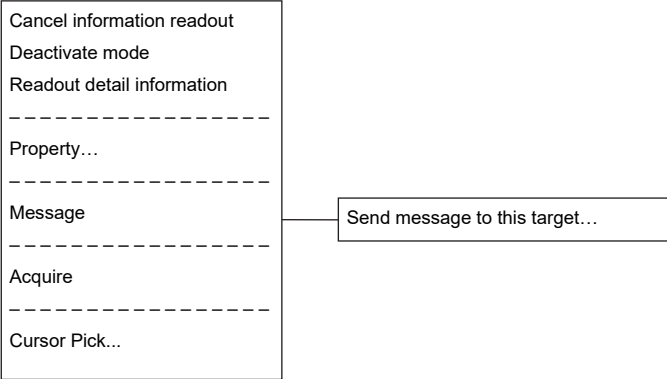

B.2.3 TT

B.2.3.1 Internal TT

Readout information
Cancel TT
Cancel all TT
Cancel TT mode

Property...

Cursor Pick...

B.2.3.2 External TT

Readout information

Property...

Cursor Pick...

B.2.3.3 TT detail information display (internal TT)

Cancel information readout
Cancel TT
Cancel all TT
Cancel TT mode

Property...

Cursor Pick...

B.2.3.4 TT detail information display (external TT)

Cancel information readout

Property...

Cursor Pick...

B.2.4 NAVTEX

B.2.4.1 NAVTEX

Readout NAVTEX information

Cursor Pick...

B.2.5 Mariner's Mark/Line

B.2.5.1 Event mark

Delete this object.

Show Mark/Line List

Cursor Pick...

B.2.5.2 Information mark

Move this object.
Delete this object.

Show Mark/Line List

Cursor Pick...

B.2.5.3 Current mark

Move this object
Delete this object.

Show Mark/Line List

Cursor Pick...

B.2.5.4 Clearing line

Move start point
Move end point
Move this object.
Delete this object.

Show Mark/Line List

Cursor Pick...

B.2.5.5 Highlighted display

Insert vertex
Move vertex
Delete vertex

Move this object.
Delete this object.

Show Mark/Line List

Cursor Pick...

B.2.6 User map

B.2.6.1 Symbol

Move this object.
Delete this object.

Show Mark/Line List

Cursor Pick...

B.2.6.2 Simple line

Add vertex
Insert vertex
Move vertex
Delete vertex

Select All
Move this object.
Delete this object.

Show Mark/Line List

Cursor Pick...

B.2.6.3 Line - Circle

Change radius
Move this object.
Delete this object.

Show Mark/Line List

Cursor Pick...

B.2.6.4 Line - Ellipse

Change horizontal and vertical
Move this object.
Delete this object.

Show Mark/Line List

Cursor Pick...

B.2.6.5 Arc

Change radius
Change start angle
Change end angle
Move this object.
Delete this object.

Show Mark/Line List

Cursor Pick...

B.2.6.6 Polygon

Change radius
Change start angle
Change end angle
Move this object.
Delete this object.

Show Mark/Line List

Cursor Pick...

B.2.6.7 Area - Circle

Change radius
Move this object.
Delete this object.

Show Mark/Line List

Cursor Pick...

B.2.6.8 Area - Ellipse

Change horizontal and vertical
Move this object.
Delete this object.

Show Mark/Line List

Cursor Pick...

B.2.6.9 Fan

Change radius
Change start angle
Change end angle
Move this object.
Delete this object.

Show Mark/Line List

Cursor Pick...

B.2.6.10 Text

Move this object.
Delete this object.

Show Mark/Line List

Cursor Pick...

B.2.6.11 Arrow

Move start point
Move end point
Move this object.
Delete this object.

Show Mark/Line List

Cursor Pick...

B.2.7 Manual Update (S-57)

B.2.7.1 Symbol

Move this object.
Delete this object.
Remove this object.

Cursor Pick...

View-Options...

B.2.7.2 Simple line

Insert vertex

Select All
Move this object.
Delete this object.
Remove this object

Cursor Pick...

View-Options...

B.2.7.3 Line - Circle

Move this object.
Delete this object.
Remove this object.

Cursor Pick...

View-Options...

B.2.7.4 Line - Ellipse

Move this object.
Delete this object.
Remove this object.

Cursor Pick...

View-Options...

B.2.7.5 Arc

Move this object.
Delete this object.
Remove this object.

Cursor Pick...

View-Options...

B.2.7.6 Polygon

Insert vertex

Move this object.
Delete this object.
Remove this object.

Cursor Pick...

View-Options...

B.2.7.7 Area - Circle

Move this object.
Delete this object.
Remove this object.

Cursor Pick...

View-Options...

B.2.7.8 Area - Ellipse

Move this object.
Delete this object.
Remove this object.

Cursor Pick...

B.2.7.9 Fan

Move this object.
Delete this object.
Remove this object.

Cursor Pick...

View-Options...

B.2.7.10 Text

Move this object.
Delete this object.
Remove this object.

Cursor Pick...

View-Options...

B.2.7.11 Arrow

Move this object.
Delete this object.
Remove this object.

Cursor Pick...

View-Options...

B.2.8 Manual Update (ARCS, C-MAP)

B.2.8.1 Objects that have not been saved

Same as "B.2.6 User map".

B.2.8.2 Saved objects (hidden)

Hide
Restore

Show Mark/Line List

Readout manual update information...

Cursor Pick...

B.2.9 Monitored route

B.2.9.1 Monitored route

Readout WPT information ...

Edit this route

Cursor Pick...

B.2.10 Planned track

B.2.10.1 Planned track

Add WPT
Insert WPT
Move WPT
Delete WPT
Change XTD
Divide leg...

Copy this route
Paste this route

Rotate this route
Move this route
Insert other route

Select route

B.2.11 Monitoring dragging anchor

B.2.11.1 Dragging anchor monitoring circle

Change radius
Move this object.
Finish Monitoring Anchor.

Cursor Pick

B.2.11.2 Dragging anchor monitoring polygon

Insert vertex
Delete vertex
Move this object.
Delete this object.

Cursor Pick

B.3 Abbreviations of Geodetic Data

No.	Geodetic Data	Display to the top screen	DTM sentence	
			Abbreviation	User-defined No.
0	WGS 84	WGS 84	W84	0
1	WGS 72	WGS 74	W74	1
2	Tokyo	TOY	TOY	2
3	North American 1927(USA)	NAS	NAS(*2)	3
4	North American 1927(Canada & Alaska)	NAS	NAS(*2)	4
5	European 1950	EUR	EUR	5
6	Australian Geodetic 1966	AUA	AUA	6
7	Ordnance Survey of Great Britain	OGB	OGB	7
8	North American 1983	NAR	NAR	8
9	No Use	Blank display	-	9
10	No Use	Blank display	-	10
11	Adindan	ADI	ADI	11
12	Arc 1950	ARF	ARF	12
13	Australian Geodetic 1984	AUG	AUG	13
14	Bermuda 1957	BER	BER	14
15	Bogota Observatory	BOO	BOO	15
16	Campo Inchauspe	CAI	CAI	16
17	Chatam Island Astro 1971	CHI	CHI	17
18	Chua Astro	CHU	CHU	18
19	Corrego Alegre	COA	COA	19
20	Djakarta (Batavia)	BAT	BAT	20
21	European 1979	EUS	EUS	21
22	Geodetic Datum 1949	GEO	GEO	22
23	Guam 1963	GUA	GUA	23
24	Hayford 1910	024	024(*1)	24
25	Hjorsey 1955	HJO	HJO	25
26	Indian	IND	IND	26
27	Ireland 1965	IRL	IRL	27
28	Kertau 1948	KEA	KEA	28
29	L. C. 5 Astro 1961	LCF	LCF	29
30	Liberia 1964	LIB	LIB	30
31	Luzon	LUZ	LUZ	31
32	Merchich	MER	MER	32
33	Minna	MIN	MIN	33

No.	Geodetic Data	Display to the top screen	DTM sentence	
			Abbreviation	User-defined No.
34	Nahrwan	NAH	NAH	34
35	Naparima, BWI	NAP	NAP	35
36	Old Egyptian 1907	OEG	OEG	36
37	Old Hawaiian	OHA	OHA	37
38	Pico de las Nieves	PLN	PLN	38
39	Provisional South American 1956	PRP	PRP	39
40	Provisional South Chilean 1963	HIT	HIT	40
41	Puerto Rico	PUR	PUR	41
42	Qornoq	QUO	QUO	42
43	RT 90	043	043(*1)	43
44	Sao Braz	SAO	SAO	44
45	South American 1969	SAN	SAN	45
46	Graciosa Base SW 1948	GRA	GRA	46
47	Timbalai 1948	TIL	TIL	47
48	No Use	Blank display	-	48
49	No Use	Blank display	-	49

B.4 Lists of Terminologies, Units, and Abbreviations

Abbreviation	Term
A	
A/D = AD	Analog/ Digital
A/P = AP	Auto Pilot
AC	Alternating Current
ACC	Actual Course Change
ACCA	Actual Course Change Alarm
ACK	Acknowledge
ACQ	Acquire, Acquisition
ACT	Activate
AIO	Admiralty Information Overlay (additional information to the navigation)
AIS	Automatic Identification System
ALC	Alert LAN Converter
AMP	Amplifiers
AMS	Alert Management System
ANT	Antenna
ARCS	Admiralty Raster Chart Service (A raster chart published by UKHO.)
ASCII	American Standard Code for Information Interchange
ASIC	Application Specific Integrated Circuit
AtoN	Aids to Navigation
AUTO = auto	Automatic
Av. = AVE	Average
AVCS	Admiralty Vector Chart Service
AZ	Acquisition Zone
AZI	Azimuth Stabilisation Mode
B	
BAM	Bridge Alert Management
BCR	Bow Crossing Range
BCT	Bow Crossing Time
BFT	Beaufort
BNWAS	Bridge Navigational Watch Alarm System
BP	Bearing Pulse
BRG	Bearing
BWW	Bearing to waypoint to waypoint
BZ	Bearing Zero

Abbreviation	Term
C	
C UP	Course Up
CA-CFAR	Cell Averaging CFAR
Cargo.Cat	Cargo Category
CCRP	Consistent Common Reference Point
CCRS	Consistent Common Reference System
CCU	Central Control Unit
CCW	Counterclockwise
CFAR	Constant False Alarm Rate
CH	Channel
CHG	Change
CID	Conning Information Display
CIF	Companion MPU Interface
CLR	Clear
COG	Course Over the Ground
COM	Communication Port
CONT	Contrast, Control
CONV	Conventional
CORREL	Correlation
CPA	Closest Point of Approach
CPP	Controllable Pitch Propeller
CPU	Central Processing Unit
CTW	Course Through the Water
Curr.	Current
CW	Clockwise
D	
D/N	Day/Night
DC	Direct Current
Def.	Definition
DGPS	Differential GPS
DIFF	Difference
DIR = Dir.	Direction
DISP = Disp	Display
DIST	Distance
DR	Dead Reckoning, Dead Reckoned Position
DSC	Digital Selective Calling
DSP	Digital Signal Processor
DWOL	Distance to Wheel Over Line

Abbreviation	Term
E	
EBL	Electronic Bearing Line
ECC	Early Course Change
ECDIS	Electronic Chart Display and Information System
Ed.	Edition
EGC	Enhanced Group Calling
ENC	Electronic Navigational Chart
ENH	Enhance
EOT	End of Track
EP	Estimated Position
EPA	Electronic Plotting Aids
EPFS	Electronic Position Fixing System
EQUIP	Equipment
ETA	Estimated Time of Arrival
F	
FPGA	Field Programmable Gate Array
FTC	Fast Time Constant
FWD	Forward
G	
GC	Great Circle
GIF	Gyro Interface
GLONASS	Global Orbiting Navigation Satellite System
GND	Ground
GNSS	Global Navigation Satellite System
GPS	Global Positioning System
GZ	Guard Zone
H	
H UP	Head Up
H/W = HW	HardWare
HASP	Hardware Against Software Piracy
HC	Heading Control
HCS	Heading Control System
HDG	Heading
HDOP	Horizontal Dilution of Precision
HL	Heading Line
HO	Hydrographic Organization
HSC	High Speed Craft

Abbreviation	Term
I	
I/F = IF	Interface
I/O	Input/Output
IALA	International Association of Marine Aids to Navigation and Lighthouse Authorities
IALA-A	IALA - Region A
IALA-B	IALA - Region B
ID	Identification
IMO	International Maritime Organization
IND	Indication
INFO	Information
INIT	Initialisation
INS	Integrated Navigation System
INT	Interval
IP Address	Internet Protocol Address
IR	Interference Rejection
ISW	Interswitch
J	
JB	Junction Box
K	
KOPU	Keyboard Operation Unit
L	
L/L = LL	Latitude/ Longitude
LAN	Local Area Network
LAT	Latitude
LCD	Liquid Crystal Display
LMT	Local Mean Time
LON	Longitude
LOP	Line of Position
LORAN	Long Range Navigation
LP	Long Pulse
M	
M/E	Main Engine
MAG	Magnetic
MAN	Manual
MAX	Maximum
MBS	Main Bang Suppression
MFDF	Medium Frequency Direction Finding
MHV	Modulator High Voltage
MIC	Microphone

Abbreviation	Term
MID	Middle
MIN	Minimum
MMSI	Maritime Mobile Services Identity Number
MOB	Man Overboard
MON	Monitor
MP	Medium Pulse
MSC	Maritime Safety Committee
MSG	Message
N	
N UP	North Up
NAV = NAVI	Navigation
NAVTEX	Navigational Telex
NE	North East
NFU	Non Follow Up
NLT	Not Less Than
NMEA	National Marine Electronics Association
NMEA0183	NMEA 0183 standards
NMT	Not More Than
No. = NUM	Number
NW	North West
O	
OPE	Operation
OPU	Operation Unit
OSD	Own Ship Data
OVRD	Override
P	
PI	Parallel Index Line
PIN	Personal Identification Number
PL	Pulse Length
PORT	Port/ Portside
POS = POSN	Position
PPI	Plan Position Indicator
PRF	Pulse Repetition Frequency
PROC	Process
PS	Power Supply
PSU	Power Supply Unit
PWR	Power
Q	
R	

Abbreviation	Term
R	Relative
RADAR	Radio Detecting and Ranging
RAND	Random
RCID	Raster Chart Issue Date
REF	Reference
REL	Relative
Rev.	Revolution
RIF	Radar I/F Circuit
RL	Rhumb Line
RM	Relative Motion
RM(R)	Relative Motion. Relative Trails.
RM(T)	Relative Motion. True Trails.
RMS	Root Mean Square
RNC	Raster Navigational Chart
RNG	Range
RoRo	Roll On/ Roll Off (Vessel)
ROM	Read Only Memory
ROT	Rate of Turn
RPS	Route Planning System
RX	Receiver
S	
SA	Scheme Administrator
SAR	Search and Rescue
SART	Search and Rescue Transponder
SATNAV	Satellite Navigation
SBAS	Satellite Based Augmentation System
SCL	Serial LAN Converter
SDK	Software Development Kit
SE	South East
SEL	Select
SENC	System Electronic Navigational Chart
Seq	Sequence
SFI	System Function ID
S-JOY	Steering Joystick Controller
SLC	Serial LAN Interface Circuit
SOG	Speed Over the Ground
SP	Short Pulse
SPD	Speed
Sprslvl	Spurious Level













Abbreviation	Term
SSD	Solid State Drive
SSE	Security Scheme Error
SSR	Solid State Radar
SSW	Safety Switch
STAB	Stabilised, Stabilisation
STBD	Starboard, Starboard Side
STC	Sensitivity Time Control
STD	Standard
STW	Speed Through the Water
SW HUB	Switching Hub
SYNC	Synchronisation
SYS	System
T	
T	True
T & P	Temporary and Preliminary Notice to Mariners
TCPA	Time to CPA
TCS	Track Control System
TD	Time Difference
TEMP / Temp.	Temperature
TGT	Target
TM	True Motion
TNI	Tune Indicator
TOPU	Trackball Operation Unit
TPL	Transferred Line of Position
TRX	Transceiver
TT	Target Tracking
TTG	Time to Go
TWOL	Time to Wheel Over Line
TX	Transmitter
TXRX	Transmitter Receiver Unit
U	
U.Map	User Map
UNACK	Un-Acknowledge
Up.No.	Update Number
USB	Universal Serial Bus
UTC	Coordinated Universal Time
V	
VD	Video
VDIN	Video In













Abbreviation	Term
VDR	Voyage Data Recorder
Ver.	Version
VHF	Very High Frequency
VOL	Volume
VRM	Variable Range Marker
W	
W UP	Waypoint Up
WGS	World Geodetic System
WIG	Wing-in-ground effect craft
WOL	Wheel Over Line
WPT	Waypoint
WS	Work Station
WTRST	Watch Timer Reset
X	
XTD	Cross Track Distance
XTE	Cross Track Error
XTL	Cross Track Limit, Route Width
Y	
Z	
Unit	
bps	bit per second
cm	centimetre
dB	decibel
deg	degree
fm	fathom
ft	feet, foot
h = hr	hour
hPa	hecto pascal
Hz	hertz
kg	kilogram
km	kilometre
kn = kts	knot
m	metre
mbar	millibar
min	minute
mph	mile per hour
NM	nautical mile
RAD	radius
rpm	revolutions per minute
s	second











Abbreviation	Term
sm	statute mile

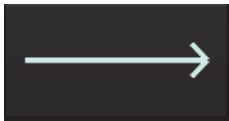

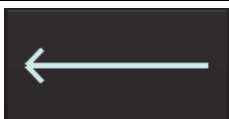





B.5 Icon Button List for User Map





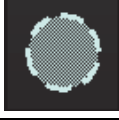
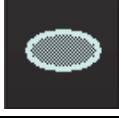

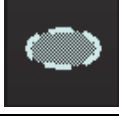

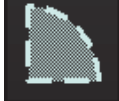

The lists of icon buttons that are used for user map are provided below.

Button name	Icon name	Icon display example	Alert generated when the own ship approaches the object
[Mariner's Mark/Line] button	Information mark		No alert
	Tidal stream		No alert
	Clearing line		No alert
	Highlight		No alert
[Symbol] button	Circle		No alert
	Triangle		No alert
	Square		No alert
	Diamond		No alert
	Multiple mark		No alert
	Warning symbol		Crossing a danger (dangerous symbol)
	Warning symbol		Crossing a User defined Warning Object
	Alert symbol		Crossing a User defined Alert Object

Button name	Icon name	Icon display example	Alert generated when the own ship approaches the object
[Line] button	Simple line(solid line)		No alert
	Simple line(dotted line)		No alert
	Simple line(dashed line)		No alert
	Circle(solid line)		No alert
	Circle(dotted line)		No alert
	Circle(dashed line)		No alert
	Eclipse(solid line)		No alert
	Eclipse(dotted line)		No alert
	Eclipse(dashed line)		No alert
	Arc(solid line)		No alert
	Arc(dotted line)		No alert
	Arc(dashed line)		No alert

Button name	Icon name	Icon display example	Alert generated when the own ship approaches the object
[Line] button	Caution line		Crossing a User defined Caution Object
	Warning line		Crossing a User defined Warning Object
	Alert line		Crossing a User defined Alert Object
	Arrow(Start To End/Small)		No alert
	Arrow(Start To End/Medium)		No alert
	Arrow(Start To End/Large)		No alert
	Arrow(End To Start/Small)		No alert
	Arrow(End To Start/Medium)		No alert
	Arrow(End To Start/Large)		No alert
	Arrow(Both Direct/Small)		No alert
	Arrow(Both Direct/Medium)		No alert
	Arrow(Both Direct/Large)		No alert

Button name	Icon name	Icon display example	Alert generated when the own ship approaches the object
[Area] button	Polygon(solid line)		No alert
	Polygon(dotted line)		No alert
	Polygon(dashed line)		No alert
	Circle(solid line)		No alert
	Circle(dotted line)		No alert
	Circle(dashed line)		No alert
	Eclipse(solid line)		No alert
	Eclipse(dotted line)		No alert
	Eclipse(dashed line)		No alert
	Fan(solid line)		No alert
	Fan(dotted line)		No alert
	Fan(dashed line)		No alert

Button name	Icon name	Icon display example	Alert generated when the own ship approaches the object
[Area] button	Caution Detection(solid line)		Crossing a User defined Caution Object
	Caution Detection(dotted line)		Crossing a User defined Caution Object
	Caution Detection(dashed line)		Crossing a User defined Caution Object
	Warning Detection(solid line)		Crossing a User defined Warning Object
	Warning Detection(dotted line)		Crossing a User defined Warning Object
	Warning Detection(dashed line)		Crossing a User defined Warning Object
	Alarm Detection(solid line)		Crossing a User defined Alarm Object
	Alarm Detection(dotted line)		Crossing a User defined Alarm Object
	Alarm Detection(dashed line)		Crossing a User defined Alarm Object
[Text] button	Text		No alert

B.6 Icon Button List for Manual Update (S-57)

The lists of icon buttons that are used for user map manual update are provided below.

How to reference the lists

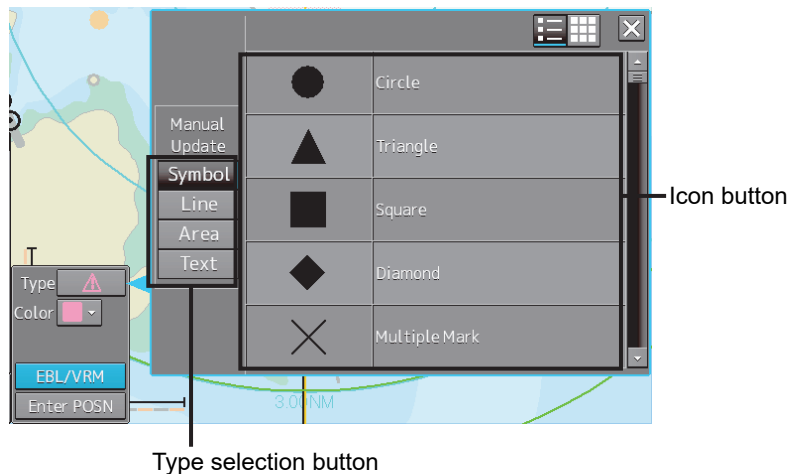

Icon buttons are displayed in list format

[List categories]

Lists are classified by "Type Selection Button".

- For [Symbol] type icon buttons, refer to "B.6.1 Symbol".
- For [Line] type icon buttons, refer to "B.6.2 Line".
- For [Area] type icon buttons, refer to "B.6.3 Area".

[Names displayed when tooltip of the icon button and the icon button display list are displayed]

The name of the icon button is displayed under "category name-object name". For instance, when the category name is Can buoy and the object name is Light-flare, default, the name is displayed as Can buoy-Light-flare, default.

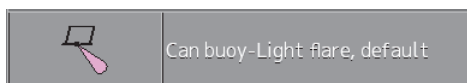





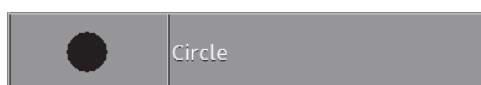

















Exception



























- When the category name in the list is enclosed by parentheses, only the object name is displayed without displaying the category name. For instance, when the category name is (General) and the object name is Circle, Circle is displayed.

























- When the object name of the list is "(No object)", only the category name is displayed. For instance, when the category name is Barrel buoy and the object name is "(No object)", Barrel buoy is displayed.

B.6.1 Symbol









Object name	Icon button display example	Remarks
Circle		
Triangle		
Square		
Diamond		
Multiple mark		
Warning symbol		
Airport/airfield		
Anchor berth		
Anchorage area		
Beacon, cardinal		
Beacon, isolated danger		
Beacon, lateral		
Beacon, safe water		
Beacon, special purpose/general		
Berth		
Building, single		
Built-up area		
Buoy, cardinal		
Buoy, installation		
Buoy, isolated danger		
Buoy, lateral		
Buoy, safe water		















Object name	Icon button display example	Remarks
Buoy, special purpose/general		
Cargo transshipment area		
Caution area		
Checkpoint		
Coastguard station		
Control point		
Crane		
Current - non-gravitational		
Dam		
Daymark		
Distance mark		
Dumping ground		
Fishing facility		
Fog signal		
Fortified structure		
Gate		
Harbour facility		
Hulk		
Incineration area		
Land area		
Land elevation		
Land region		
Landmark		
Light		
Light float		
Light vessel		
Local magnetic anomaly		















Object name	Icon button display example	Remarks
Log pond		
Magnetic variation		
Marine farm/culture		
Military practice area		
Mooring/Warping facility		
Nautical publication information		
New Object		
Obstruction		
Offshore platform		
Pile		
Pilot boarding place		
Pipeline area		
Precautionary area		
Production/storage area		
Pylon/bridge support		
Radar reflector		
Radar station		
Radar transponder beacon		
Radio calling-in point		
Radio station		
Recommended traffic lane part		
Rescue station		
Retro-reflector		
Sand waves		
Sea area/named water area	Text	
Seabed area	mud	
Sea-plane landing area		















Object name	Icon button display example	Remarks
Shoreline construction		
Signal station, traffic		
Signal station, warning		
Silo/tank		
Slope topline		
Sloping ground		
Small craft facility		
Sounding		
Spring		
Tidal stream - flood/ebb		
Tidal stream - harmonic prediction		
Tidal stream - non-harmonic prediction		
Tidal stream - time series		
Tidal stream panel data		
Tide - harmonic prediction		
Tide - non-harmonic prediction		
Tide - time series		
Topmark		
Underwater/awash rock		
Vegetation		
Water turbulence		
Weed/Kelp		
Wreck		











B.6.2 Line

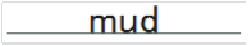

Object name	Icon button display example	Remarks
Simple line(solid line)		
Simple line(dotted line)		
Simple line(dashed line)		
Circle(solid line)		
Circle(dotted line)		
Circle(dashed line)		
Eclipse(solid line)		
Eclipse(dotted line)		
Eclipse(dashed line)		
Arc(solid line)		
Arc(dotted line)		
Arc(dashed line)		
Warning line		
Arrow(Start To End/Small)		

Object name	Icon button display example	Remarks
Arrow(Start To End/Medium)		
Arrow(Start To End/Large)		
Arrow(End To Start/Small)		
Arrow(End To Start/Medium)		
Arrow(End To Start/Large)		
Arrow(Both Direct/Small)		
Arrow(Both Direct/Medium)		
Arrow(Both Direct/Large)		
Archipelagic Sea Lane Axis		
Berth		
Bridge		Object name attribute value is "Text"
Cable, overhead		
Cable, submarine		
Canal		











Object name	Icon button display example	Remarks
Causeway		
Conveyor		Vertical clearance attribute value is "Text"
Dam		
Deep water route centerline		Orientation attribute value is "Text"
Dyke		
Fence/wall		
Ferry route		
Fishing facility		
Floating dock		
Fortified structure		
Gate		
Land area	Text	Object name attribute value is "Text"
Land elevation		
Landmark		
Local magnetic anomaly		





Object name	Icon button display example	Remarks
Magnetic variation		
Marine farm/culture		
Mooring/Warping facility		
Navigation line		
New Object		
Obstruction		
Oil barrier		
Pipeline, overhead		Vertical clearance attribute value is "Text"
Pipeline, submarine/on land		
Pontoon		
Radar line		Orientation attribute value is "Text"
Radio calling-in point		
Railway		
Rapids		







Object name	Icon button display example	Remarks
Recommended route centerline		Orientation attribute value is "Text"
Recommended track		Orientation attribute value is "Text"
River		
Road		
Runway		
Sand waves		
Seabed area		Nature of surface attribute value is "mud"
Shoreline construction		
Slope topline		
Straight territorial sea baseline		
Tideway		
Traffic separation line		
Traffic separation scheme boundary		
Tunnel		
Vegetation		

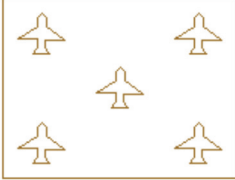
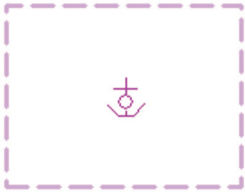



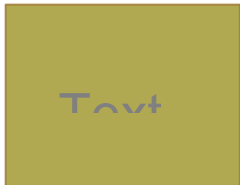

Object name	Icon button display example	Remarks
Water turbulence		
Waterfall		







B.6.3 Area





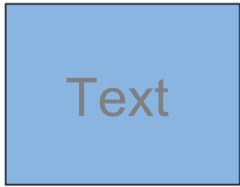
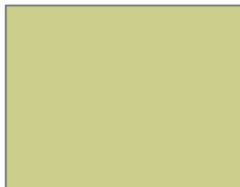

Object name	Icon button display example	Remarks
Polygon(solid line)		
Polygon(dotted line)		
Polygon(dashed line)		
Circle(solid line)		
Circle(dotted line)		
Circle(dashed line)		
Eclipse(solid line)		
Eclipse(dotted line)		
Eclipse(dashed line)		
Fan(solid line)		
Fan(dotted line)		







Object name	Icon button display example	Remarks
Fan(dashed line)		
Warning Area(solid line)		
Warning Area(dotted line)		
Warning Area(dashed line)		
Administration Area (Named)		
Airport/airfield		
Anchor berth		
Anchorage area		Object name attribute value is "Text"





Object name	Icon button display example	Remarks
Archipelagic Sea Lane		
Berth		Object name attribute value is "Text"
Bridge		Object name attribute value is "Text"
Building, single		
Built-up area		Object name attribute value is "Text"
Cable area		
Canal		







Object name	Icon button display example	Remarks
Cargo transhipment area		
Causeway		
Caution area		
Checkpoint		
Contiguous zone		
Continental shelf area		
Conveyor		Vertical clearance attribute value is "Text"

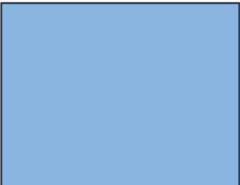





Object name	Icon button display example	Remarks
Crane		
Custom zone		
Dam		
Deep water route part		
Dock area		Object name attribute value is "Text"
Dry dock		
Dumping ground		







Object name	Icon button display example	Remarks
Dyke		
Exclusive economic zone		
Fairway		Object name attribute value is "Text"
Ferry route		
Fishery zone		
Fishing facility		
Fishing ground		





Object name	Icon button display example	Remarks
Fortified structure		
Free port area		
Gate		
Gridiron		
Harbour area (administrative)		
Harbour facility		
Ice area		





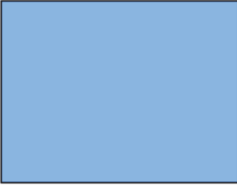

Object name	Icon button display example	Remarks
Incineration area		
Inshore traffic zone		
Lake		
Land region	<p style="text-align: center;">Text</p>	Object name attribute value is "Text"
Landmark		
Local magnetic anomaly		
Lock basin		







Object name	Icon button display example	Remarks
Log pond		
Magnetic variation		
Marine farm/culture		
Military practice area		
Mooring/Warping facility		
Nautical publication information		
Navigational system of marks		







Object name	Icon button display example	Remarks
New Object		
Obstruction		
Offshore platform		Object name attribute value is "Text"
Offshore production area		
Pilot boarding place		
Pipeline area		
Precautionary area		





Object name	Icon button display example	Remarks
Production/storage area		
Pylon/bridge support		
Radar range		
Rapids		
Recommended track		
Recommended traffic lane part		
Restricted area		

Object name	Icon button display example	Remarks
River		
Road		
Runway		
Sand waves		
Sea area/named water area	<p style="text-align: center;">Text</p>	Object name attribute value is "Text"
Seabed area	<p style="text-align: center;">mud</p>	Nature of surface attribute value is "mud"
Sea-plane landing area		

Object name	Icon button display example	Remarks
Shoreline construction		
Silo/tank		
Sloping ground		
Small craft facility		
Submarine transit lane		
Swept Area		Depth range value 1 attribute value is "Text"
Territorial sea area		

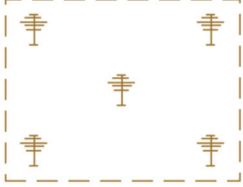
Object name	Icon button display example	Remarks
Tidal stream - flood/ebb		
Tidal stream - harmonic prediction		
Tidal stream - non-harmonic prediction		
Tidal stream - time series		
Tidal stream panel data		
Tide - harmonic prediction		
Tide - non-harmonic prediction		

Object name	Icon button display example	Remarks
Tide - time series		
Tideway		Object name attribute value is "Text"
Traffic separation scheme crossing		
Traffic separation scheme lane part		
Traffic separation scheme roundabout		
Traffic separation zone		
Tunnel		

Object name	Icon button display example	Remarks
Two-way route part		
Vegetation		
Water turbulence		
Weed/Kelp		
Wreck		

B.6.4 Text

Object name	Icon button display example	Remarks
Text		

B.6.5 ENC object attributes

The input rules of the ENC object attributes that are handled by manual update are specified in “S-57 Appendix A Chapter 2 – Attributes”. The following six types of ENC object attributes are available.

Attribute type	
enumerated('E')	One option can be selected from the options.
list('L')	Although this type is the same as enumerated, multiple items can be selected.
float('F')	Decimal digits can be input.
integer('I')	Integers can be input.
coded string('A')	Free text
free text('S')	Free text

To display an object correctly in manual update, the input must comply with the specification indicated in “S-57 Appendix A Chapter 2 - Attributes”.

For types 'E', 'L', and 'F', the options and the input range are displayed in the input dialog. For types 'A' and 'S', input the values according to the rules that are provided below.

Attribute: Communication channel

Acronym: COMCHA

Code: 77

Attribute type: A

Definition:

A channel number assigned to a specific radio frequency, frequencies or frequency band.

Expected input:

enter specific VHF-Channel

References:

INT 1: IM 40;

M-4: 488;

The attribute ' communication channel ' encodes the various VHF-channels used for communication.

Indication:

Each VHF-channel should be indicated by 2 digits and up to 2 characters (A-Z);

e.g. VHF-channel 7 -> > 07'

VHF-channel 16 -> > 16';

The indication of several VHF-channels is possible;

Format:

[XXXX];[XXXX];...

Attribute: Date end

Acronym: DATEND

Code: 85

Attribute type: A

Indication:

the 'date, end' should be encoded using 4 digits for the calendar year (CCYY), 2 digits for the month

(MM) (e.g. April = 04) and 2 digits for the day (DD), according to ISO 8601: 1988.

Format:

CCYYMMDD (mandatory)

Example:

19961007 for 07 October 1996 as ending date.

Remarks:

The attribute 'date end' indicates the latest date on which an object (e.g. a buoy) will be present.

This attribute is to be used to indicate the removal or cancellation of an object at a specific date in the

future. See also 'periodic date end'

Attribute: Date start

Acronym: DATSTA

Code: 86

Attribute type: A

Indication:

The 'date, start' should be encoded using 4 digits for the calendar year (CCYY), 2 digits for the month

(MM) (e.g. April = 04) and 2 digits for the day (DD), according to ISO 8601: 1988.

Format:

CCYYMMDD (mandatory)

Example:

19960822 for 22 August 1996 as starting date.

Remarks:

The attribute 'date, start' indicates the earliest date on which an object (e.g. a buoy) will be present.

This attribute is to be used to indicate the deployment or implementation of an object at a specific date

in the future. See also 'periodic date start'.

APP B

Attribute: Nationality

Acronym: NATION

Code: 111

Attribute type: A

Indication:

the nationality is encoded by a 2 character- code following ISO 3166 (refer to Annex A to S-57 Appendix A);

Format:

c2 (mandatory)

Remarks:

The attribute 'nationality' indicates the nationality of the specific object.

Attribute: Periodic date end

Acronym: PEREND

Code: 118

Attribute type: A

Definition:

The end of the active period for a seasonal object (e.g. a buoy). See also 'date end'.

References:

INT 1: IQ71;

M-4: 460.5;

Indication:

the 'periodic date end' should be encoded using 4 digits for the calendar year (CCYY), 2 digits for the

month (MM) (e.g. April = 04) and 2 digits for the day (DD). When no specific year is required (ie the

object is removed at the same time each year) the following two cases may be considered:

- same day each year: --MMDD

- same month each year: --MM

This conforms to ISO 8601: 1988.

Format:

CCYYMMDD (full date, **mandatory**)

--MMDD (same day each year, **mandatory**)

--MM (same month each year, **mandatory**)

Example:

--1015 for an ending date of 15 October each year.

Remarks:

No remarks.

Attribute: Periodic date start

Acronym: PERSTA

Code: 119

Attribute type: A

Definition:

The start of the active period for a seasonal object (e.g. a buoy). See also 'date start'.

References:

INT 1: IQ71;

M-4: 460.5;

Indication:

the 'periodic date, start' should be encoded using 4 digits for the calendar year (CCYY), 2 digits for

the month (MM) (e.g. April = 04) and 2 digits for the day (DD). When no specific year is required (ie

the object is deployed at the same time each year) the following two cases may be considered:

- same day each year: --MMDD

- same month each year: --MM

This conforms to ISO 8601: 1988.

Format:

CCYYMMDD (full date, **mandatory**)

--MMDD (same day each year, **mandatory**)

--MM (same month each year, **mandatory**)

Example:

--04 for an operation starting in April each year.

Remarks:

No remarks.

Attribute: Radar wave length

Acronym: RADWAL

Code: 126

Attribute type: A

Definition:

The distance between two successive peaks (or other points of identical phase) on an electromagnetic wave in the radar band of the electromagnetic spectrum.

References:

INT 1: IS 3.1-4;

M-4: 486.3-4;

APP B

Indication:

the wavelength and the band code character is indicated;

In the case where two bands should be encoded, these should be separated by a comma.

Unit : m

resolution: 0.01 m

Format:

V.VV-B

V.VV-B,V.VV-B

'VV.VV' encodes the value of wavelength.

'B' encodes the band;

each separated by a hyphen ('-')

Example:

the radar transponder beacon wavelength '3cm (X) - Band' is indicated as '0.03-X'

Remarks:

The attribute 'radar transponder beacon wavelength' encodes the specific wavelength at which a radar

transponder beacon transmits.

Radar transponder beacons generally work on the following wavelengths:

- 3cm (X) - Band

- 10cm (S) - Band

Nevertheless, wavelengths outside the marine band are used.

Attribute: Reference year for magnetic variation

Acronym: RYRMGV

Code: 130

Attribute type: A

Definition:

The reference calendar year for magnetic variation values.

References:

INT 1: IB 68.1, 70-71;

M-4: 270;

Indication:

the 'reference calendar year for magnetic variation' should be encoded using a 4 digit year-indication

(CCYY).

Format:

CCYY (mandatory)

Attribute: Signal group

Acronym: SIGGRP

Code: 141

Attribute type: A

Definition:

The number of signals, the combination of signals or the morse character(s) within one period of full sequence.

References:

INT 1: IP 10.2-9; IR 20, 22;

M-4: 453; 453.1-4; 471.2;

Indication:

The signal group of a light is encoded using brackets to separate the individual groups. A group of

signals may be a single number, a chain of numbers separated by "+", a sequence of up to 4 letters

or a letter and a number.

A fixed light has no signal group.

Where no specific signal group is given for one of the light characteristics, this should be shown by

an empty pair of brackets.

Format:

(c)(c)...

Examples:

Light characteristic SIGGRP Indication

VQ(6)+LFI -> (6)(1)

FI+LFI (2+3) -> (1)(2+3)

FI(2)+Lfl(3) -> (2)(3)

FFI -> ()(1)

Mo(AA) -> (AA)

AIFI(2W+1R) -> (2+1)

AILFIWR -> (2)

FOcW -> ()(1)

AIOc(4)WR -> (4)

Attribute: Signal sequence

Acronym: SIGSEQ

Code: 143

Attribute type: A

Definition:

The sequence of times occupied by intervals of light and eclipse for all 'light characteristics' except

for occulting where the sequence of times is occupied by intervals of eclipse and light.

Indication:

Unit for value of intervals: second (s)

resolution: 0.01 s

Format:

LL.L + (EE.E)

Example:

00.8+(02.2)+00.8+(05.2)

The above example encodes a signal sequence with two intervals of light and two intervals of eclipse.

For occulting lights, the 'signal sequence' is indicated using a fixed format to encode the values of

intervals of eclipse (E) and (L).

Format:

(EE.E)+LL.L

Example:

(00.8)+02.2+(00.8)+05.2)

The above example encodes a signal sequence with two intervals of eclipse and two intervals of light.

Remarks:

The 'signal sequence' for all 'light characteristics' except for occulting is indicated using a fixed format

to encode the value of intervals of light (L) and eclipse (E).

Attribute: Tidal stream - panel values

Acronym: TS_TSP

Code: 159

Attribute type: A

Indication:

The direction in degrees and velocity in knots are encoded in pairs. Each value separated by a comma.

Example:

63230,Darwin,HW,124,2.2,128,2.1,125,2.9,116,2.8,110,2.0,095,0.6,020,0.2,320,1.9,315,2.1,300,
2.
8,268,2.6,200,2.4,165,2.5

Remarks:

The attribute 'Tidal stream - panel values' encodes the identification of the reference station with reference water level and the direction of the flow and the springs rate from 6 hours before to 6 hours after high water (HW) or low water (LW) at the reference station, at hourly intervals. The relationship to a reference station is encoded using a collection object.

Attribute: Tidal stream, current - time series values**Acronym: TS_TSV****Code: 160****Attribute type: A****Indication:**

The direction in degrees and velocity in knots are encoded in pairs. Each value separated by a comma.

Example:

135,1.5,156,1.9,301,1.1,342,0.9

Remarks:

The attribute 'Tidal stream, current - time series values' encodes values for a direction and velocity time series.

Attribute: Tide - high and low water values**Acronym: T_HWLW****Code: 162****Attribute type: A****Indication:**

Dates/times and heights are to be encoded in pairs, each value separated by a comma.

The date/time should be encoded using 4 digits for the calendar year (CCYY), 2 digits for the month

(MM) (eg April = 04) and 2 digits for the day (DD), separated by a capital AT@ from the hour (hh) and

minutes (mm) which should each be encoded using 2 digits. This conforms to ISO 8601: 1988. Seconds should not be used.

The height should be given in metres (xx.x) with a resolution of 0.1 metre.

Format:

CCYYMMDDThhmm,xx.x,CCYYMMDDThhmm,xx.x

Example:

19950428T1020,1.2,19950428T1455,4.8,...

Remarks:

The attribute 'tide - high and low water values' encodes information on the times and heights of high

and low waters for each day of the duration of the time series.

Attribute: Tide - time and height differences

Acronym: T_THDF

Code: 164

Attribute type: A

Indication:

time difference in hours and minutes: " hhmm (according to ISO 8106: 1988)

height difference: metres (preceded with A-@ if negative value)

rate difference: knots (preceded with A-@ if negative value)

Example:

Tidal height: 63230, Darwin,-0040,-0.7,0.9

Tidal stream: 59060, Cairns,+0130,1.2,-0.7

Remarks:

The attribute 'tide - time and height differences' encodes the time and tidal height or tidal stream rate

difference comparative to a reference station.

The format is the same for tides and tidal streams, with height difference being replaced by rate difference. The relation to a reference station is encoded by the use of a collection object.

The attribute is used to contain the identification of the reference station and , encoded in triplets,

mean time difference (+ or -), height or rate difference for mean high water or mean high rate (preceded with A-@ if negative value), height or rate difference for mean low water or mean low rate

(preceded with A-@ if negative value), each value separated by a comma.

Attribute: Time end

Acronym: TIMEND

Code: 168

Attribute type: A

Indication:

The 'time end' will consist of a date and a time separated by a capital AT@. The date should be encoded using 4 digits for the calendar year (CCYY), 2 digits for the month (MM) (e.g. April = 04) and

2 digits for the day (DD). The time should be encoded using 2 digits for the hour (hh), 2 digits for the

minutes (mm) and 2 digits for the seconds (ss). This conforms to ISO 8601: 1988.

Format:

CCYYMMDDThhmmss (**mandatory**)

Example:

19940426T094500 for a period ending at 09:45 am on 26 April 1994.

Remarks:

The attribute 'time end' indicates the end of a active period.

Attribute: Time start

Acronym: TIMSTA

Code: 169

Attribute type: A

Indication:

The 'time start' will consist of a date and a time separated by a capital AT@. The date should be encoded using 4 digits for the calendar year (CCYY), 2 digits for the month (MM) (e.g. April = 04) and

2 digits for the day (DD). The time should be encoded using 2 digits for the hour (hh), 2 digits for the

minutes (mm) and 2 digits for the seconds (ss). This conforms to ISO 8601: 1988.

Format:

CCYYMMDDThhmmss (**mandatory**)

Example:

19940212T162000 for a period starting at 04:20 pm on 12 February 1994.

Remarks:

The attribute 'time start' indicates the start of an active period.

Attribute: Call sign

Acronym: CALSGN

Code: 6

Attribute type: S

Definition:

The designated call-sign of a radio station.

References:

INT 1: not specified;

M-4: not specified;

Remarks:

No remarks.

Attribute: Object name

Acronym: OBJNAM

Code: 116

Attribute type: S

Definition:

The individual name of an object.

References:

INT 1: ID 7, IF 19, IN 12.2-3;

M-4: 371; 323.1-2; 431.2-3; 431.5;

Remarks:

No remarks.

Attribute: Pilot district

Acronym: PILDST

Code: 121

Attribute type: S

Definition:

The area within which a particular pilotage service operates.

References:

INT 1: IT 1.2;

M-4: 491.1-2;

Remarks:

No remarks.

Attribute: Object class definition

Acronym: CLSDEF

Code: 190

Attribute type: S

Definition:

Specifies the defining characteristics of a 'new object'.

Remarks:

Identical definitions must be used for other instances of identical features being encoded.
The wording for the attribute CLSDEF must be approved by TSMAD before use.

Attribute: Object class name

Acronym: CLSNAM

Code: 191

Attribute type: S

Definition:

Specifies the descriptive name of a 'new object' feature object class.

Remarks:

All 'new objects' of the same class must share the same CLSNAM.
The wording for the attribute CLSNAM must be approved by TSMAD before use.

Attribute: Object name in national language

Acronym: NOBJNM

Code: 301

Attribute type: S

References:

INT 1: ID 7, IF 19, IN 12.2-3;
M-4: 371; 323.1-2; 431.2-3; 431.5;

Indication:

Name of object (c...):string of national language characters

Format:

c...

Remarks:

The attribute 'object name in national language' encodes the individual name of an object in the specified national language.

Attribute: Pilot district in national language

Acronym: NPLDST

Code: 302

Attribute type: S

References:

INT 1: IT 1.2;
M-4: 491.1-2;

Indication:

Pilot district (c...):string of national language characters

Format:

c...

Remarks:

The attribute 'pilot district in national language' encodes the pilot district for which a pilot station is responsible in the specified national language.

B.7 Icon Button List for Manual Update (ARCS and C-MAP)

The lists of icon buttons that are used for user map manual update are provided below.

How to reference the lists

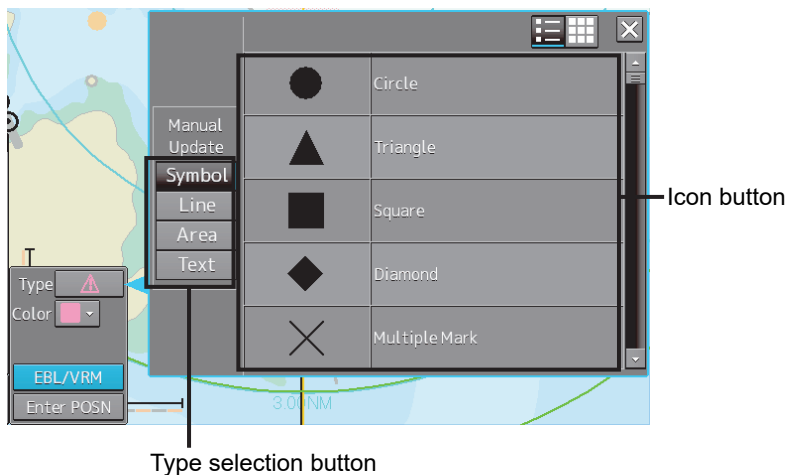

Icon buttons are displayed in list format

[List categories]

Lists are classified by "Type Selection Button".

- For [Symbol] type icon buttons, refer to "B.7.1 Symbol".
- For [Line] type icon buttons, refer to "B.7.2 Line".
- For [Area] type icon buttons, refer to "B.7.3 Area".

[Names displayed when tooltip of the icon button and the icon button display list are displayed]

The name of the icon button is displayed under "category name-object name". For instance, when the category name is Can buoy and the object name is Light-flare, default, the name is displayed as Can buoy-Light-flare, default.

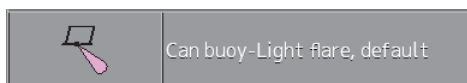





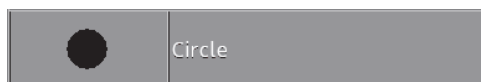













Exception



















- When the category name in the list is enclosed by parentheses, only the object name is displayed without displaying the category name. For instance, when the category name is (General) and the object name is Circle, Circle is displayed.







































- When the object name of the list is "(No object)", only the category name is displayed. For instance, when the category name is Barrel buoy and the object name is "(No object)", Barrel buoy is displayed.



















B.7.1 Symbol



















Category name	Object name	Icon button display example	Alert generated when the own ship approaches the object
(General)	Circle		No alert
	Triangle		No alert
	Square		No alert
	Diamond		No alert
	Multiple mark		No alert
	Warning symbol		Crossing a danger (dangerous symbol)
(Manual Update)	Delete symbol		No alert
(Anchor)	Anchor Point		No alert
	Anchorage Area		No alert
	Anchor Berth		No alert
	Anchor Prohibited Area		No alert
Barrel buoy	(No object name)		Crossing a danger (dangerous symbol)
	Light flare, default		Crossing a danger (dangerous symbol)
	Light flare, red		Crossing a danger (dangerous symbol)
	Light flare, green		Crossing a danger (dangerous symbol)
	Light flare, white/yellow		Crossing a danger (dangerous symbol)
Can buoy	(No object name)		Crossing a danger (dangerous symbol)
	Light flare, default		Crossing a danger (dangerous symbol)



















Category name	Object name	Icon button display example	Alert generated when the own ship approaches the object
Can buoy	Light flare, red		Crossing a danger (dangerous symbol)
	Light flare, green		Crossing a danger (dangerous symbol)
	Light flare, white/yellow		Crossing a danger (dangerous symbol)
Conical buoy	(No object name)		Crossing a danger (dangerous symbol)
	Light flare, default		Crossing a danger (dangerous symbol)
	Light flare, red		Crossing a danger (dangerous symbol)
	Light flare, green		Crossing a danger (dangerous symbol)
	Light flare, white/yellow		Crossing a danger (dangerous symbol)
Installation buoy	(No object name)		Crossing a danger (dangerous symbol)
	Light flare, default		Crossing a danger (dangerous symbol)
	Light flare, red		Crossing a danger (dangerous symbol)
	Light flare, green		Crossing a danger (dangerous symbol)
	Light flare, white/yellow		Crossing a danger (dangerous symbol)
Mooring buoy, barrel shape	(No object name)		Crossing a danger (dangerous symbol)
	Light flare, default		Crossing a danger (dangerous symbol)
	Light flare, red		Crossing a danger (dangerous symbol)
	Light flare, green		Crossing a danger (dangerous symbol)
	Light flare, white/yellow		Crossing a danger (dangerous symbol)



















Category name	Object name	Icon button display example	Alert generated when the own ship approaches the object
Mooring buoy, can shape	(No object name)		Crossing a danger (dangerous symbol)
	Light flare, default		Crossing a danger (dangerous symbol)
	Light flare, red		Crossing a danger (dangerous symbol)
	Light flare, green		Crossing a danger (dangerous symbol)
	Light flare, white/yellow		Crossing a danger (dangerous symbol)
Pillar buoy	(No object name)		Crossing a danger (dangerous symbol)
Pillar buoy - Cone point up	(No object name)		Crossing a danger (dangerous symbol)
	Light flare, default		Crossing a danger (dangerous symbol)
	Light flare, red		Crossing a danger (dangerous symbol)
	Light flare, green		Crossing a danger (dangerous symbol)
	Light flare, white/yellow		Crossing a danger (dangerous symbol)
Pillar buoy - Cone point down	(No object name)		Crossing a danger (dangerous symbol)
	Light flare, default		Crossing a danger (dangerous symbol)
	Light flare, red		Crossing a danger (dangerous symbol)
	Light flare, green		Crossing a danger (dangerous symbol)
	Light flare, white/yellow		Crossing a danger (dangerous symbol)
Pillar buoy - 2 cones point upward	(No object name)		Crossing a danger (dangerous symbol)
	Light flare, default		Crossing a danger (dangerous symbol)



















Category name	Object name	Icon button display example	Alert generated when the own ship approaches the object
Pillar buoy - 2 cones point upward	Light flare, red		Crossing a danger (dangerous symbol)
	Light flare, green		Crossing a danger (dangerous symbol)
	Light flare, white/yellow		Crossing a danger (dangerous symbol)
Pillar buoy - 2 cones point downward	(No object name)		Crossing a danger (dangerous symbol)
	Light flare, default		Crossing a danger (dangerous symbol)
	Light flare, red		Crossing a danger (dangerous symbol)
	Light flare, green		Crossing a danger (dangerous symbol)
	Light flare, white/yellow		Crossing a danger (dangerous symbol)
Pillar buoy - 2 cones base to base	(No object name)		Crossing a danger (dangerous symbol)
	Light flare, default		Crossing a danger (dangerous symbol)
	Light flare, red		Crossing a danger (dangerous symbol)
	Light flare, green		Crossing a danger (dangerous symbol)
	Light flare, white/yellow		Crossing a danger (dangerous symbol)
Pillar buoy - 2 cones point to point	(No object name)		Crossing a danger (dangerous symbol)
	Light flare, default		Crossing a danger (dangerous symbol)
	Light flare, red		Crossing a danger (dangerous symbol)
	Light flare, green		Crossing a danger (dangerous symbol)
	Light flare, white/yellow		Crossing a danger (dangerous symbol)
Pillar buoy - Sphere	(No object name)		Crossing a danger (dangerous symbol)



















Category name	Object name	Icon button display example	Alert generated when the own ship approaches the object
Pillar buoy - Sphere	Light flare, default		Crossing a danger (dangerous symbol)
	Light flare, red		Crossing a danger (dangerous symbol)
	Light flare, green		Crossing a danger (dangerous symbol)
	Light flare, white/yellow		Crossing a danger (dangerous symbol)
Pillar buoy - 2 spheres	(No object name)		Crossing a danger (dangerous symbol)
	Light flare, default		Crossing a danger (dangerous symbol)
	Light flare, red		Crossing a danger (dangerous symbol)
	Light flare, green		Crossing a danger (dangerous symbol)
	Light flare, white/yellow		Crossing a danger (dangerous symbol)
Pillar buoy - Cylinder	(No object name)		Crossing a danger (dangerous symbol)
	Light flare, default		Crossing a danger (dangerous symbol)
	Light flare, red		Crossing a danger (dangerous symbol)
	Light flare, green		Crossing a danger (dangerous symbol)
	Light flare, white/yellow		Crossing a danger (dangerous symbol)
Pillar buoy - Board	(No object name)		Crossing a danger (dangerous symbol)
	Light flare, default		Crossing a danger (dangerous symbol)
	Light flare, red		Crossing a danger (dangerous symbol)
	Light flare, green		Crossing a danger (dangerous symbol)
	Light flare, white/yellow		Crossing a danger (dangerous symbol)

















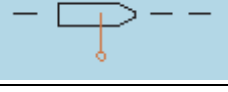

Category name	Object name	Icon button display example	Alert generated when the own ship approaches the object
Pillar buoy - Cube point up	(No object name)		Crossing a danger (dangerous symbol)
	Light flare, default		Crossing a danger (dangerous symbol)
	Light flare, red		Crossing a danger (dangerous symbol)
	Light flare, green		Crossing a danger (dangerous symbol)
	Light flare, white/yellow		Crossing a danger (dangerous symbol)
Pillar buoy - Flag or other shape	(No object name)		Crossing a danger (dangerous symbol)
	Light flare, default		Crossing a danger (dangerous symbol)
	Light flare, red		Crossing a danger (dangerous symbol)
	Light flare, green		Crossing a danger (dangerous symbol)
	Light flare, white/yellow		Crossing a danger (dangerous symbol)
Pillar buoy - T-Shape	(No object name)		Crossing a danger (dangerous symbol)
	Light flare, default		Crossing a danger (dangerous symbol)
	Light flare, red		Crossing a danger (dangerous symbol)
	Light flare, green		Crossing a danger (dangerous symbol)
	Light flare, white/yellow		Crossing a danger (dangerous symbol)
Pillar buoy - X-shape	(No object name)		Crossing a danger (dangerous symbol)
	Light flare, default		Crossing a danger (dangerous symbol)
	Light flare, red		Crossing a danger (dangerous symbol)
	Light flare, green		Crossing a danger (dangerous symbol)



















Category name	Object name	Icon button display example	Alert generated when the own ship approaches the object
Pillar buoy - X-shape	Light flare, white/yellow		Crossing a danger (dangerous symbol)
Spherical buoy	(No object name)		Crossing a danger (dangerous symbol)
	Light flare, default		Crossing a danger (dangerous symbol)
Spherical buoy	Light flare, red		Crossing a danger (dangerous symbol)
	Light flare, green		Crossing a danger (dangerous symbol)
	Light flare, white/yellow		Crossing a danger (dangerous symbol)
Spar buoy	(No object name)		Crossing a danger (dangerous symbol)
	Light flare, default		Crossing a danger (dangerous symbol)
	Light flare, red		Crossing a danger (dangerous symbol)
	Light flare, green		Crossing a danger (dangerous symbol)
	Light flare, white/yellow		Crossing a danger (dangerous symbol)
Super-buoy	(No object name)		Crossing a danger (dangerous symbol)
	Light flare, default		Crossing a danger (dangerous symbol)
	Light flare, red		Crossing a danger (dangerous symbol)
	Light flare, green		Crossing a danger (dangerous symbol)
	Light flare, white/yellow		Crossing a danger (dangerous symbol)
LANBY, super-buoy	(No object name)		Crossing a danger (dangerous symbol)
	Light flare, default		Crossing a danger (dangerous symbol)
	Light flare, red		Crossing a danger (dangerous symbol)



















Category name	Object name	Icon button display example	Alert generated when the own ship approaches the object
LANBY, super-buoy	Light flare, green		Crossing a danger (dangerous symbol)
	Light flare, white/yellow		Crossing a danger (dangerous symbol)
Light float	(No object name)		Crossing a danger (dangerous symbol)
	Light flare, default		Crossing a danger (dangerous symbol)
	Light flare, red		Crossing a danger (dangerous symbol)
	Light flare, green		Crossing a danger (dangerous symbol)
	Light flare, white/yellow		Crossing a danger (dangerous symbol)
Light vessel	(No object name)		Crossing a danger (dangerous symbol)
	Light flare, default		Crossing a danger (dangerous symbol)
	Light flare, red		Crossing a danger (dangerous symbol)
	Light flare, green		Crossing a danger (dangerous symbol)
	Light flare, white/yellow		Crossing a danger (dangerous symbol)
Beacon in general	(No object name)		No alert
	Cone point up		No alert
	Cone point down		No alert
	2 cones point upward		No alert
	2 cones point downward		No alert
	2 cones base to base		No alert
	2 cones point to point		No alert

Category name	Object name	Icon button display example	Alert generated when the own ship approaches the object
Beacon in general	Sphere		No alert
	2 spheres		No alert
	Cylinder		No alert
	Board		No alert
	Cube point up		No alert
	X-shape		No alert
	Upright cross		No alert
	Besom point down		No alert
	Besom point up		No alert
	T-shape		No alert
Lattice beacon	(No object name)		No alert
	Cone point up		No alert
	Cone point down		No alert
	2 cones point upward		No alert
	2 cones point downward		No alert
	2 cones base to base		No alert
	2 cones point to point		No alert
	Sphere		No alert
	2 spheres		No alert











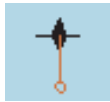

Category name	Object name	Icon button display example	Alert generated when the own ship approaches the object
Lattice beacon	Cylinder		No alert
	Board		No alert
	Cube point up		No alert
	X-shape		No alert
	Upright cross		No alert
	Besom point down		No alert
	Besom point up		No alert
	T-shape		No alert
Beacon tower	(No object name)		No alert
	Cone point up		No alert
	Cone point down		No alert
	2 cones point upward		No alert
	2 cones point downward		No alert
	2 cones base to base		No alert
	2 cones point to point		No alert
	Sphere		No alert
	2 spheres		No alert
	Cylinder		No alert











Category name	Object name	Icon button display example	Alert generated when the own ship approaches the object
Beacon tower	Board		No alert
	Cube point up		No alert
	X-shape		No alert
	Upright cross		No alert
	Besom point down		No alert
	Besom point up		No alert
	T-shape		No alert
(Ports and Harbors)	Berth number		No alert
	Ferry area		No alert
	Cable ferry area		No alert
	Fortified structure		No alert
	Conspicuous fortified structure		No alert
	Fish trap, fish weir, tunny net		No alert
	Fish stakes		No alert
	Fishing harbor		No alert
	Marine farm/aquaculture		No alert
	RoRo terminal		No alert
	Mooring dolphin		No alert
Deviation mooring dolphin		No alert	





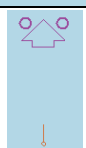
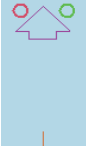

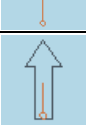
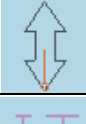

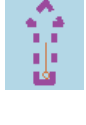









Category name	Object name	Icon button display example	Alert generated when the own ship approaches the object
(Ports and Harbors)	Pile or bollard		No alert
	Yacht harbor, marina		No alert
(Buildings)	Airport		No alert
	Opening bridge		No alert
	Built-up area		No alert
	Non-conspicuous religious building, Christian		No alert
	Conspicuous religious building, Christian		No alert
	Non-conspicuous religious building, non-Christian		No alert
	Conspicuous religious building, non-Christian		No alert
	Minaret		No alert
	Conspicuous minaret		No alert
	Single building		No alert
	Conspicuous single building		No alert
	Cairn		No alert
	Conspicuous cairn		No alert
	Chimney		No alert
	Conspicuous chimney		No alert
	Cranes		No alert
	Dome		No alert



















Category name	Object name	Icon button display example	Alert generated when the own ship approaches the object
(Buildings)	Conspicuous dome		No alert
	Dish aerial		No alert
	Conspicuous dish aerial		No alert
	Flagstaff, flagpole		No alert
	Flare stack		No alert
	Conspicuous flare stack		No alert
	Hulk		No alert
	Monument		No alert
	Conspicuous monument		No alert
	Mast		No alert
	Conspicuous mast		No alert
	Mine, quarry		No alert
	Quarry		No alert
	Refinery		No alert
	Conspicuous refinery		No alert
	Silo		No alert
	Conspicuous silo		No alert
	Timber yard		No alert
	Tank		No alert

Category name	Object name	Icon button display example	Alert generated when the own ship approaches the object
(Buildings)	Conspicuous tank		No alert
	Tank farm		No alert
	Conspicuous tank farm		No alert
	Tower		No alert
	Conspicuous tower		No alert
	Water tower		No alert
	Conspicuous water tower		No alert
	Radio, television tower		No alert
	Conspicuous radio, television tower		No alert
	Wind-motor		No alert
	Conspicuous wind-motor		No alert
	Wind generator farm		No alert
	Conspicuous wind generator farm		No alert
	Windmill		No alert
	Conspicuous windmill		No alert
(Artificial Feature)	Navigable lock gate		No alert
	Non-navigable lock gate		No alert
	Offshore platform		No alert
(Miscellaneous Station)	Coastguard station		No alert













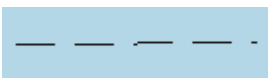
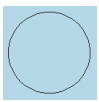



Category name	Object name	Icon button display example	Alert generated when the own ship approaches the object
(Caution)	Rescue station		No alert
	Pilot station		No alert
	Signal station		No alert
	Mariner's information note		No alert
	Mariner's caution note		No alert
(Dangerous)	Underwater hazard with a defined depth		Crossing a danger (dangerous symbol)
	Underwater hazard with depth greater than 20 metres		Crossing a danger (dangerous symbol)
	Hazard on the surface		Crossing a danger (dangerous symbol)
	Floating hazard to navigation		No alert Because the object included in ENC does not change to "Isolated danger" depending on the safety contour. This is defined in S-52.
(Obstructions)	Isolated danger of depth less than the safety contour		Crossing a danger (dangerous symbol)
	Obstruction, depth not stated		Crossing a danger (dangerous symbol)
	Obstruction in the intertidal area		No alert Because the object included in ENC does not change to "Isolated danger" depending on the safety contour. This is defined in S-52.
	Obstruction		Crossing a danger (dangerous symbol)





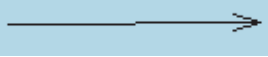











Category name	Object name	Icon button display example	Alert generated when the own ship approaches the object
(Obstructions)	Obstruction in the water which is always above water level		Crossing a danger (dangerous symbol)
	Dangerous underwater rock of uncertain depth		Crossing a danger (dangerous symbol)
	Rock which covers and uncovers or is awash at low water		Crossing a danger (dangerous symbol)
	Wreck showing any portion of hull or superstructure at level of chart datum		Crossing a danger (dangerous symbol)
	Non-dangerous wreck, depth unknown		Crossing a danger (dangerous symbol)
	Dangerous wreck, depth unknown		Crossing a danger (dangerous symbol)
	Direction of buoyage		No alert
	Direction and color of buoyage for approaching harbor in IALA region A (red to port)		No alert
	Direction and color of buoyage for approaching harbor in IALA region B (green to port)		No alert
	Fairway with one-way traffic in direction indicated		No alert
	Fairway with two-way traffic		No alert
	Inshore traffic		No alert
	Recommended traffic direction between parts of a traffic separation scheme, or for ships not needing a deep water route		No alert

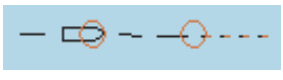



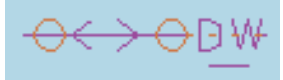







Category name	Object name	Icon button display example	Alert generated when the own ship approaches the object
(Obstructions)	Recommended two-way track as an area, based on fixed marks		No alert
	Recommended one-way track as an area, based on fixed marks		No alert
	Traffic roundabout		No alert
	Reciprocal traffic directions in a two-way route of a traffic separation scheme		No alert
	Single traffic direction in a two-way route part of a traffic separation scheme		No alert
	Traffic crossing area		No alert
	Part of deep water route		No alert
	Reciprocal traffic directions in a two-way part of a deep-water route		No alert
	Traffic direction in a one way lane of a traffic separation scheme		No alert
(Restricted Area)	Prohibited or restricted area		No alert
(Fishing Ground)	Fishing ground		No alert
	Fish haven		No alert
	Fishing or trawling is prohibited or restricted		No alert
(Radio/Radar)	Radio calling-in point for traffic in one direction only		No alert
	Radio calling-in point for traffic in both directions		No alert
	Radio station		No alert
	Radar transponder beacon		No alert
	Radar conspicuous		No alert



Category name	Object name	Icon button display example	Alert generated when the own ship approaches the object
(Radio/Radar)	Radar reflector		No alert
	Radar scanner		No alert
	Conspicuous radar scanner		No alert
	Retro reflector		No alert
(Fog signal)	Fog signal		No alert
(Local Magnetic anomaly)	Magnetic anomaly at a point		No alert
	Magnetic anomaly along a line or over an area		No alert
	Magnetic variation at a point		No alert
	Magnetic variation along a line or over an area		No alert
(Natural Feature/ Seabed)	Hill or mountain top		No alert
	Conspicuous hill or mountain top		No alert
	Cable area		No alert
	Foul area of seabed safe for navigation but not for anchoring		No alert
	Sand waves		No alert
	Spring		No alert
	Weed, kelp		No alert
(Unknown)	? Mark		No alert
	Generic Object		No alert

B.7.2 Line

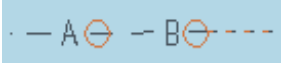
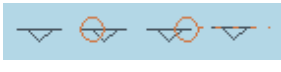

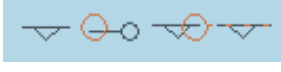











Category name	Object name	Icon button display example	Alert generated when the own ship approaches the object
(General)	Simple line(solid line)		No alert
	Simple line(dotted line)		No alert
	Simple line(dashed line)		No alert
	Circle(solid line)		No alert
	Circle(dotted line)		No alert
	Circle(dashed line)		No alert
	Eclipse(solid line)		No alert
	Eclipse(dotted line)		No alert
	Eclipse(dashed line)		No alert
	Arc(solid line)		No alert
	Arc(dotted line)		No alert
	Arc(dashed line)		No alert
	Warning line		Dangerous line
	Arrow(Start To End/Small)		No alert
	Arrow(Start To End/Medium)		No alert
	Arrow(Start To End/Large)		No alert
	Arrow(End To Start/Small)		No alert
	Arrow(End To Start/Medium)		No alert

Category name	Object name	Icon button display example	Alert generated when the own ship approaches the object
(General)	Arrow(End To Start/Large)		No alert
	Arrow(Both Direct/Small)		No alert
	Arrow(Both Direct/Medium)		No alert
	Arrow(Both Direct/Large)		No alert
(Manual Update)	Deletion by a manual update		No alert
(Anchor)	Boundary of an anchorage area		Dangerous line
	Boundary of an area where anchoring is prohibited or restricted		Dangerous line
(Ferry Routes)	Ferry route		No alert
	Cable ferry route		No alert
(Ports and Harbors)	Fishing stakes		No alert
(Caution)	Boundary of area with a specific caution		Dangerous line
	Boundary of area to be navigated with caution		Dangerous line
(Routes)	Two-way deep water route centerline, based on fixed marks		No alert
	One-way deep water route centerline, based on fixed marks		No alert
	Boundary of a deep water route		No alert
	Regulated two-way recommended route centerline, based on fixed marks		No alert
	Regulated one-way recommended route centerline, based on fixed marks		No alert

Category name	Object name	Icon button display example	Alert generated when the own ship approaches the object
(Routes)	Non-regulated recommended two-way track, based on fixed marks		Dangerous line
	Non-regulated recommended one-way track, based on fixed marks		Dangerous line
	Archipelagic Sea Lane		No alert
(Restricted Area)	Boundary of an area where entry is prohibited or restricted		Dangerous line
	Boundary of a restricted area		Dangerous line
(Administered Area)	Jurisdiction boundary		No alert
(Fishing Ground)	Boundary of an area where trawling or fishing is prohibited or restricted		Dangerous line
(Cable/Pipe)	Boundary of a submarine cable area		Dangerous line
	Submarine cable		No alert
	Oil, gas pipeline, submerged or on land		No alert
	Water pipeline, sewer, etc.		No alert
(Miscellaneous Boundary)	Boundary between IALA-A and IALA-B systems of lateral buoys and beacons		No alert
	Boundary of a navigation feature such as a fairway, magnetic anomaly, etc.		Dangerous line
	Boundary of a submarine pipeline area with potentially dangerous contents		Dangerous line
	Boundary of a submarine pipeline area with generally non-dangerous contents		No alert

Category name	Object name	Icon button display example	Alert generated when the own ship approaches the object
(Unknown)	? Mark		No alert
	Generic Object		No alert

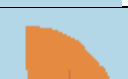
B.7.3 Area

Category name	Object name	Icon button display example	Alert generated when the own ship approaches the object
(General)	Polygon(solid line)		No alert
	Polygon(dotted line)		No alert
	Polygon(dashed line)		No alert
	Circle(solid line)		No alert
	Circle(dotted line)		No alert
	Circle(dashed line)		No alert
	Eclipse(solid line)		No alert
	Eclipse(dotted line)		No alert
	Eclipse(dashed line)		No alert
	Fan(solid line)		No alert
	Fan(dotted line)		No alert
	Fan(dashed line)		No alert
	Warning Area(solid line)		Dangerous area
	Warning Area(dotted line)		Dangerous area
	Warning Area(dashed line)		Dangerous area











B.7.4 Text

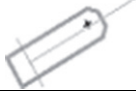

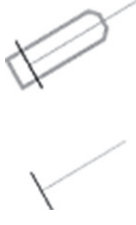
Category name	Object name	Icon button display example	Alert generated when the own ship approaches the object
(General)	Text		No alert

B.8 List of Navigation-related Symbols

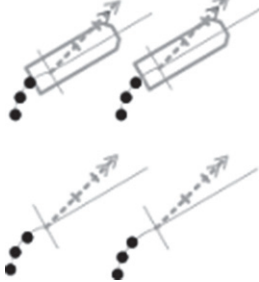
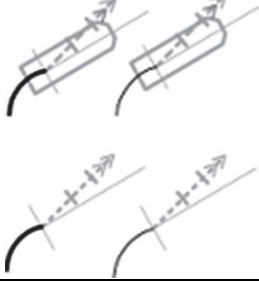
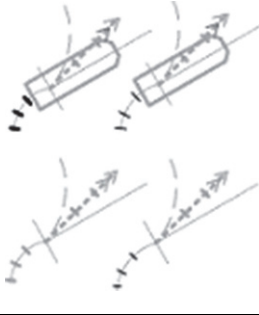

The navigation-related symbols that are displayed in this equipment are listed below.

B.8.1 Related to own ship symbols

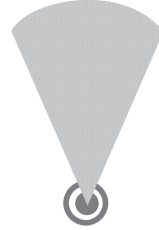

No.	Drawn object name	Drawn object display example
1	Own ship symbol (True Scaled Outline)	
2	Own ship symbol (Simplified Symbol)	
3	Radar antenna position	
4	Heading Line	
5	Beam Line	
6	Stern Line	
7	Vector	
8	Ground vector indicator	
9	Water vector indicator	
10	Own ship track Time Mark	
11	POS2 Symbol	

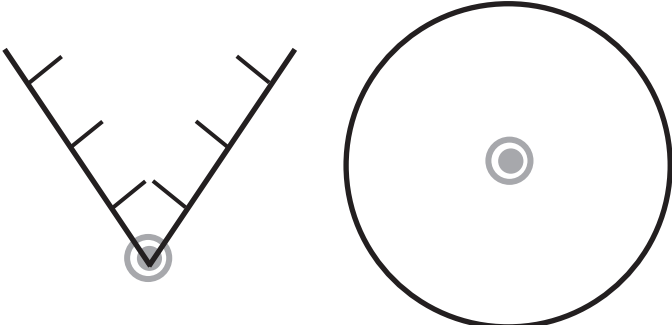
No.	Drawn object name	Drawn object display example
12	PastPOSN	
13	Own ship track	
14	Own ship track Time Mark	
15	Vector Area (Anti-grounding monitoring)	
16	Sector Area (Anti-grounding monitoring)	



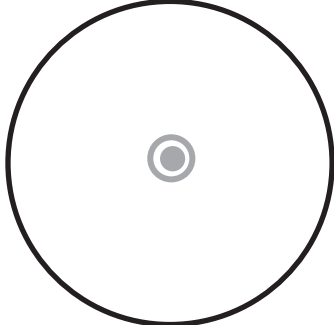

B.8.2 TT/AIS related

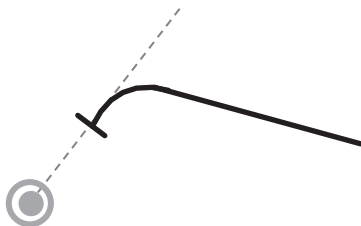

No.	Drawn object name	Drawn object display example
1	AZ	
2	AIS Filter	
3	Sector Blank	

B.8.3 Navigation monitoring related

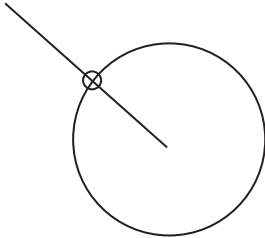
No.	Drawn object name	Drawn object display example
1	Dredging anchor monitoring circle *Thick red circle	
2	WPT	
	Routes	
3	EBL Maneuver	

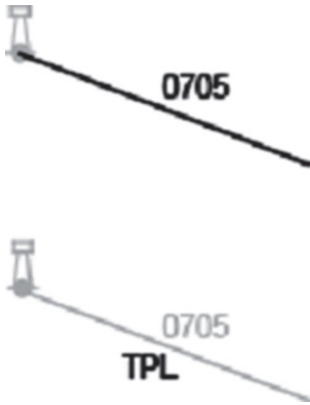













B.8.4 Tool related













No.	Drawn object name	Drawn object display example
1	Range Ring	
2	EBL	
3	VRM	
4	Node Fixed EBL/VRM *Thin orange line and circle	
5	PI	
6	MOB	
7	LOP	













No.	Drawn object name	Drawn object display example
8	Plotted Position	<p>1115  GNSS</p> <p>1115  EP GNSS</p> <p>1115  DR GNSS</p>















B.9 List of Icons/Icon Buttons



















The icons/icon buttons displayed in this equipment are listed below.











No.	Name	Functional outline	Displayed image
1	Active indicator	Indicates that the computer is processing by an animation.	
2	Delete	Deletes the item.	
3	Check again	Checks the contents being displayed again.	
4	Setting mark	Displayed when the operation is valid. (E.g., Latitude and longitude offset of chart)	
5	Drive	Displayed at the left of the name when a drive is selected.	
6	Folder	Displayed at the left of the name when a folder is selected.	
7	Home	Changes from the currently displayed screen to the home screen.	
8	Close	Closes the dialog box.	
9	Date selection	Displays the calendar picker.	
10	Dialog box display	Opens another dialog box. (E.g., Route selection dialog)	
11	Day/Night	Displays the state of the current Day/Night setting by an icon.	
12	Screen brightness	Enables adjustment of the screen brightness.	
13	Panel brightness	Enables adjustment of the brightness of operation unit.	
14	MOB	Starts the MOB (Man Over Board) mode. In the MOB mode, a symbol display of the position of the sailor falling over board and a dotted line connecting it to the own ship are displayed graphically.	

No.	Name	Functional outline	Displayed image
15	Message notification	When there is a message from outside (AIS safety related messages, etc.), the number of messages is displayed in a badge over the icon. The message window is displayed when the icon is clicked.	
16	Menu	"Menu" button with freeze indicator function. Displays the menu. Indicates using animation that the system is operating.	
17	Writing tool	Changes to the writing mode, which includes user map creation [a)], manual updating [b)] and route creation [c)]. Label of icon changes according to drawing mode.	 a) b) c)
18	Cursor mode selection	Changes the cursor mode to AUTO mode.	
19	Undo	Executes an undo operation.	
20	Screen capture	Creates the capture image at the time this is pressed.	
21	Eraser tool	Changes to the user map deleting mode, and user maps can be deleted successively.	
22	Silencing	Silences the alert sound.	
23	Multiple knob (small knob)	Displays the functions assigned to the multiple knob. Displayed as an icon with the function name at left.	
24	Brightness	Sets the brightness of the screen.	
25	Page selection	The "[Page Selection] dialog box is displayed.	
26	Add page	Displays the [Page Selection] dialog box.	
27	Expand List	Displays the TT/AIS list of the standard mode newly in an expanded window.	

No.	Name	Functional outline	Displayed image
28	Standard List	Closes the expand mode TT/AIS list (separate window), and displays in the standard mode (information monitoring window pane)	
29	Standard AIS	Changes to standard AIS display.	
30	Expand AIS	Changes to expanded AIS display.	
31	Route Planning	Opens the dialog box for preparing the route. Route preparation is done by editing the table and graphic editing using the cursor.	
32	Route Monitoring	Opens the dialog box for route monitoring. When a route is selected, displays the information up to the next target location, and monitors whether the own ship is traveling according to the route.	
33	Anchor Watch	Monitors the anchor dredging. When the anchor has been lowered, monitors if the ship is being swept away	
34	Auto Sail	Starts auto sail. Before starting, a safety check of the route is made, and the result is displayed.	
35	Chart	Opens the Chart related menu.	
36	User Map	Opens the user map related menu. It is possible to write marks or lines in the user map.	
37	Logbook	Opens the dialog box of the Logbook. The ship's position, speed, direction, wind direction, wind speed, etc., are recorded at specific intervals of times, or records events that have occurred in the equipment.	
38	TT/AIS	Opens the TT/AIS related menu. This also has the function of highlighting the display of the TT/AIS symbol depending on the conditions, or the function of sending a message to an AIS ship, etc.	
39	Tools	Tool related menu, such as the range and bearing measurement EBL/VRM or PI, etc.	

No.	Name	Functional outline	Displayed image
40	View	Opens the View related menu. Settings are made of the display of objects in the radar PPI or in the chart.	
41	Alert	Opens the alert related menu. Settings related to the alerts from the equipment can be made. When clicked, the alert dialog box appears. Alert settings can be made in the dialog box.	
42	Settings	Opens the menu related to the operation settings of the equipment.	
43	Chart Maintenance	Opens the chart management related menu. Chart management including importing and updating of charts can be made.	
44	Maintenance	The maintenance related menu for the users is displayed. It is possible to check the software version and to monitor the status of the equipment.	
45	Help	Opens the help screen.	
46	Code Input	Input the password.	
47	Service	The menu related to adjustment, servicing, and maintenance is displayed for the servicing personnel.	
48	Import/Update Licence file	Imports or updates the chart licence.	
49	Import/Update charts	Imports or updates the chart data.	
50	Check Status	Checks an imported chart.	
51	C-Map	Moves to the [Licence] tab of the C-Map Chart Manager screen.	
52	Back space	Carries out a backspace operation.	
53	Backward movement of the input position	Moves back the input position.	

No.	Name	Functional outline	Displayed image
54	Forward movement of the input position	Moves the input position forward	
55	Operation guide	Displays the operation guide when clicked.	
56	Search	Displayed in the search text box.	
57	Thumbnail / list display selection	Switches between thumbnail and list displays.	 
58	Original scale	Changes the scale of the screen to the original scale of the chart being displayed at the center of the screen.	
59	Home position	Displays the chart position in which the forward direction of the own ship can be seen wide.	
60	Event	Places the event mark at the position of the own ship.	
61	Zoom Area	Makes and enlarged display of the specified square area.	
62	Offset display	Displays the offset amounts of the chart being displayed.	
63	Chart selection	Displays the chart selection dialog box for RNC.	
64	Radar Overlay	Selects ON/OFF of the Radar Overlay display.	
65	AIS display	Selects ON/OFF of the AIS display.	
66	TT	Selects ON/OFF of the TT display.	
67	Move backward	Changes the chart display to the position and scale before the display was changed.	
68	WPT center	Displays the surroundings of the WPT being selected.	
69	Between WPT-WPT	Displays between the "currently selected WPT" and the "immediately previous WPT".	
70	Overall route	Displays the entire route.	

No.	Name	Functional outline	Displayed image
71	Single	Changes the screen display to single screen.	
72	Left-right division	Changes the screen display to left-right divided screen.	
73	Top-bottom division	Changes the screen display to top-bottom divided screen.	
4	Window	Changes the screen display to picture in picture display.	
75	Surroundings not displayed	Hides the display of the tool buttons on the ECDIS screen.	
76	Discard tab	The tab is discarded (discarding the edited route).	
77	All	Consolidated mode of PI This is the mode of operating the orientation and spacing of all the parallel lines.	
78	Individual	Individual mode of PI The orientation of each line, the distance from the reference position, and the length are operated independently in this mode.	
79	Track	PI tracking mode This is the mode of operating the orientation and spacing between two parallel lines. The two parallel lines are placed to the left and right taking CCRP as the reference.	
80	Equiangular	Equal angle mode of PI This is the mode of operating the angle of two lines that intersect at the reference position.	
81	Contents selection	The display contents of the pane are changed directly	

B.10 Data Format of the File that can be Imported/Exported in the ECDIS

B.10.1 File Types

- Route file
- User map file
- Logbook file

B.10.2 File Name

	File name in device	Default exported file name
Route file	*.csv, *.*, *.rtm, *.rta, *.rtn, *.rtz	The file name that is specified by the user in "File name" of the [Export] dialog is used. The default "File Type" is *.rtm and as other types, *.rta, *.rtn, *.rtz and *.csv are available. If .rtz is selected, the route file will be exported in RTZ version 1.0 format.
User map file	*.csv, *.uchm	-
Log book file - Specified period	-	Logbook_(Specified start date _end date).csv Example: Logbook_020312_020313.csv

B.10.3 CSV File Data Structure

- At import, lines starting with "//" are processed as comments.
- Commas are used as delimiters.

Example:

```
// SYMBOL,InstName,,,,,
// Comment
// Lat,,Lon,,
SYMBOL,BOYSHP01,,
User Comment
30,6.433,N,129,35.583,E
```

B.10.4 Route File

Line	Content	Description	Import ^{*1}	Export ^{*2}
1 ^{*3}	// (space)	Fixed string		√
	ROUTE SHEET exported by JRC ECDIS.	Fixed string		√
2	// (space)	Fixed string		√
	<<NOTE>>This strings // indicate comment column/cells. You can edit freely.	Variable-length string		√
3	// (space)	Fixed string		√
	Route name	Route name of the source file		√
	,	Fixed character		√
	<Normal>	Fixed string		√
	,	Fixed character		√
	Route comment	Comment in the source file		√
4	// (space)	Fixed string		√
	WPT No.	Fixed string		√
	,	Fixed character		√
	LAT	Fixed string		√
	,	Fixed character		√
	,	Fixed character		√
	,	Fixed character		√
	LON	Fixed string		√
	,	Fixed character		√
	,	Fixed character		√
	,	Fixed character		√
	PORT[NM]	Fixed character		√
	,	Fixed character		√
	STBD[NM]	Fixed character		√
	,	Fixed character		√
	Arr.Rad[NM]	Fixed character		√
	,	Fixed character		√
	Speed[kn]	Fixed string		
	,	Fixed character		
	Sail(RL/GC)	Fixed string		
	,	Fixed character		
	ROT[deg/min]	Fixed string		
	,	Fixed character		

*1 Information retrieved at import (the same hereinafter)

*2 Information to be exported (the same hereinafter)

*3 Lines with a gray background are deemed as comments (the same hereinafter).

Line	Content	Description	Import	Export
4	Turn Rad[NM]	Fixed string		√
	,	Fixed character		√
	Time Zone	Fixed string		√
	,	Fixed character		√
	,	Fixed character		√
	Name	Fixed string		√
5	WPT No.	000	√	√
	,	Fixed character	√	√
	Latitude (degrees)	35	√	√
	,	Fixed character	√	√
	Latitude (degrees.minutes)	35.123	√	√
	,	Fixed character	√	√
	Latitude Sign (N/S)	N	√	√
	,	Fixed character	√	√
	Longitude (degrees)	139	√	√
	,	Fixed character	√	√
	Longitude (degrees.minutes)	48.234	√	√
	,	Fixed character	√	√
	Longitude Sign (E/W)	E	√	√
	,	Fixed character	√	√
	Port Cross-Track Limit	0.50	√	√
	,	Fixed character	√	√
	Starboard Cross-Track Limit	0.50	√	√
	,	Fixed character	√	√
	Arrival Circle Radius	0.50	√	√
	,	Fixed character	√	√
	Planned Ship Speed	12.3	√	√
	,	Fixed character	√	√
	Navigation (RL/GC)	RL	√	√
	,	Fixed character	√	√
	Turn rate	10.00	√	√
	,	Fixed character	√	√
	Turning Radius	0.50	√	√
	,	Fixed character	√	√
	Time Zone	09:00	√	√
	,	Fixed character	√	√
Time Zone Sign (E/W)	E	√	√	
,	Fixed character	√	√	
Name	Yokohama	√	√	
6	Hereinafter, repeat Line 5 per WPT		√	√

- On Line WPT000, fields other than the latitude and longitude (degrees, degrees.minutes, sign) are populated with "***".

B.10.5 User Map File

(1) Header record

Line	Content	Description	Import
1	// (space)	Fixed string	
	USER CHART SHEET exported by JRC ECDIS.	Fixed string	
2	// (space)	Fixed string	
	<<NOTE>>This strings // indicate comment column/cells. You can edit freely.	Variable-length string	
3	// (space)	Fixed string	
	User Chart Name	Name of the source file	
	,	Fixed character	
	,	Fixed character	
	User Chart Comment	Comment in the source file	

(2) Object records

a) Symbol

Line	Content	Description	Import	
m	// (space)	Fixed string		
	SYMBOL	Fixed string		
	,	Fixed character		
	InstName	Fixed string		
+1	// (space)	Fixed string		
	Comment	Fixed string		
+2	// (space)	Fixed string		
	Lat	Fixed string		
	,	Fixed character		
	,	Fixed character		
	,	Fixed character		
+3	Lon	Fixed string		
	SYMBOL	Fixed string	√	
	,	Fixed character	√	
	Instruction name ●=~CIRCLE0 ▲=~TRIANG0 ■=~SQUARE0 ◆=~DIAMND0 x=~XSHAPE0	~CIRCLE0	√	
	,	Fixed character	√	
	***	Fixed string	√	
	,	Fixed character	√	
	***	Fixed string	√	
	+4	Comment	Comment	√
	+5	Latitude (degrees)	35	√
,		Fixed character	√	
Latitude (degrees.minutes)		35.123	√	
,		Fixed character	√	
Latitude Sign (N/S)		N	√	
,		Fixed character	√	
Longitude (degrees)		139	√	
,		Fixed character	√	
Longitude (degrees.minutes)		48.234	√	
,	Fixed character	√		
	Longitude Sign (E/W)	E	√	

b) Danger symbol

Line	Content	Description	Import
m	// (space)	Fixed string	
	DANGER_SYMBOL	Fixed string	
	,	Fixed character	
	InstName	Fixed string	
+1	// (space)	Fixed string	
	Comment	Fixed string	
+2	// (space)	Fixed string	
	Lat	Fixed string	
	,	Fixed character	
	,	Fixed character	
	,	Fixed character	
+3	Lon	Fixed string	
	DANGER_SYMBOL	Fixed string	√
	,	Fixed character	√
	~WARNSY0	Fixed string	√
	,	Fixed character	√
	***	Fixed string	√
	,	Fixed character	√
***	Fixed string	√	
+4	Comment	Comment	√
+5	Latitude (degrees)	35	√
	,	Fixed character	√
	Latitude (degrees.minutes)	35.123	√
	,	Fixed character	√
	Latitude Sign (N/S)	N	√
	,	Fixed character	√
	Longitude (degrees)	139	√
	,	Fixed character	√
	Longitude (degrees.minutes)	48.234	√
,	Fixed character	√	
Longitude Sign (E/W)	E	√	

c) (Poly-)Line

Line	Content	Description	Import
m	// (space)	Fixed string	
	LINE_AGGREGATE	Fixed string	
+1	// (space)	Fixed string	
	Comment	Fixed string	
+2	// (space)	Fixed string	
	Lat	Fixed string	
	,	Fixed character	
	,	Fixed character	
	,	Fixed character	
	Lon	Fixed string	
	,	Fixed character	
	,	Fixed character	
	,	Fixed character	
	Type	Fixed string	
	,	Fixed character	
	Width	Fixed string	
	,	Fixed character	
	Color No.	Fixed string	
	,	Fixed character	
	Comment	Fixed string	
+3	// (space)	Fixed string	
	Add "END" to the end of vertex.	Fixed string	
+4	LINE_AGGREGATE	Fixed string	√
+5	Comment	Comment	√
+6	Vertex Latitude (degrees)	35	√
	,	Fixed character	√
	Vertex Latitude (degrees.minutes)	35.123	√
	,	Fixed character	√
	Vertex Latitude Sign (N/S)	N	√
	,	Fixed character	√
	Vertex Longitude (degrees)	139	√
	,	Fixed character	√
	Vertex Longitude (degrees.minutes)	48.234	√
	,	Fixed character	√
	Vertex Longitude Sign (E/W)	E	√
	,	Fixed character	√
	Line Type (Solid=,Dash=2,Dotted=3)	1	√
	,	Fixed character	√
Line Width (1(Thin) - 5(Thick))	1	√	
,	Fixed character	√	

Line	Content	Description	Import
+6	Color (White/Black=0,Gray=,Amber=2, Magenta=3,Blue=4,Cyan=5,Green=6, Yellow=7,Orange=8, Red=9)	8	√
	,	Fixed character	√
	Comment	Comment	√
+n	Repeat Line +6 for the number of vertexes.		√
	END	Fixed string (position end)	√

d) Circle (line)

Line	Content	Description	Import
m	// (space)	Fixed string	
	LINE_CIRCLE	Fixed string	
+1	// (space)	Fixed string	
	Comment	Fixed string	
+2	// (space)	Fixed string	
	Base Point-Lat	Fixed string	
	,	Fixed character	
	,	Fixed character	
	,	Fixed character	
	Base Point-Lon	Fixed string	
	,	Fixed character	
	,	Fixed character	
	,	Fixed character	
	Radius[nm]	Fixed string	
+3	LINE_CIRCLE	Fixed string	√
+4	Comment	Comment	√
+5	Reference Position Latitude (degrees)	35	√
	,	Fixed character	√
	Reference Position Latitude (degrees.minutes)	35.123	√
	,	Fixed character	√
	Reference Position Latitude Sign (N/S)	N	√
	,	Fixed character	√
	Reference Position Longitude (degrees)	139	√
	,	Fixed character	√
	Reference Position Longitude (degrees.minutes)	48.234	√
	,	Fixed character	√
	Reference Position Longitude Sign (E/W)	E	√
	,	Fixed character	√
	Radius [NM]	2.0	√

e) Ellipse (line)

Line	Content	Description	Import
m	// (space)	Fixed string	
	LINE_ELLIPSE	Fixed string	
+1	// (space)	Fixed string	
	Comment	Fixed string	
+2	// (space)	Fixed string	
	Base Point-Lat	Fixed string	
	,	Fixed character	
	,	Fixed character	
	,	Fixed character	
	Base Point-Lon	Fixed string	
	,	Fixed character	
	,	Fixed character	
	,	Fixed character	
	Horizontal Radius [nm]	Fixed string	
	,	Fixed character	
	Vertical Radius [nm]	Fixed string	
+3	LINE_ELLIPSE	Fixed string	√
+4	Comment	Comment	√
+5	Reference Position Latitude (degrees)	35	√
	,	Fixed character	√
	Reference Position Latitude (degrees.minutes)	35.123	√
	,	Fixed character	√
	Reference Position Latitude Sign (N/S)	N	√
	,	Fixed character	√
	Reference Position Longitude (degrees)	139	√
	,	Fixed character	√
	Reference Position Longitude (degrees.minutes)	48.234	√
	,	Fixed character	√
	Reference Position Longitude Sign (E/W)	E	√
	,	Fixed character	√
	Horizontal Radius [NM]	2.0	√
	,	Fixed character	√
Vertical Radius [NM]	1.5	√	

f) Arc

Line	Content	Description	Import
m	// (space)	Fixed string	
	ARC	Fixed string	
+1	// (space)	Fixed string	
	Comment	Fixed string	
+2	// (space)	Fixed string	
	Base Point-Lat	Fixed string	
	,	Fixed character	
	,	Fixed character	
	,	Fixed character	
	Base Point-Lon	Fixed string	
	,	Fixed character	
	,	Fixed character	
	,	Fixed character	
	Radius [nm]	Fixed string	
	,	Fixed character	
	Start Angle[deg]	Fixed string	
	,	Fixed character	
	End Angle[deg]	Fixed string	
+3	ARC	Fixed string	√
+4	Comment	Comment	√
+5	Reference Position Latitude (degrees)	35	√
	,	Fixed character	√
	Reference Position Latitude (degrees.minutes)	35.123	√
	,	Fixed character	√
	Reference Position Latitude Sign (N/S)	N	√
	,	Fixed character	√
	Reference Position Longitude (degrees)	139	√
	,	Fixed character	√
	Reference Position Longitude (degrees.minutes)	48.234	√
	,	Fixed character	√
	Reference Position Longitude Sign (E/W)	E	√
	,	Fixed character	√
	Radius [NM]	2.0	√
	,	Fixed character	√
Start Radius [deg]	120.0	√	
,	Fixed character	√	
End Radius [deg]	180.0	√	

g) User danger line

Line	Content	Description	Import
m	// (space)	Fixed string	
	DANGER_LINE_AGGREGATE	Fixed string	
+1	// (space)	Fixed string	
	Comment	Fixed string	
+2	// (space)	Fixed string	
	Lat	Fixed string	
	,	Fixed character	
	,	Fixed character	
	,	Fixed character	
	Lon	Fixed string	
	,	Fixed character	
	,	Fixed character	
	,	Fixed character	
	Type	Fixed string	
	,	Fixed character	
	Width	Fixed string	
	,	Fixed character	
	ColorNo	Fixed string	
	,	Fixed character	
	Comment	Fixed string	
+3	// (space)	Fixed string	
	Add "END" to the end of vertex.	Fixed string	
+4	DANGER_LINE_AGGREGATE	Fixed string	√
+5	Comment	Comment	√
+6	Vertex Latitude (degrees)	35	√
	,	Fixed character	√
	Vertex Latitude (degrees.minutes)	35.123	√
	,	Fixed character	√
	Vertex Latitude Sign (N/S)	N	√
	,	Fixed character	√
	Vertex Longitude (degrees)	139	√
	,	Fixed character	√
	Vertex Longitude (degrees.minutes)	48.234	√
	,	Fixed character	√
	Vertex Longitude Sign (E/W)	E	√
	,	Fixed character	√
	0	Fixed character	√
	,	Fixed character	√
	0	Fixed character	√
	,	Fixed character	√
0	Fixed character	√	



Line	Content	Description	Import
+6	,	Fixed character	√
	Comment	Comment	√
+n	Repeat Line +6 for the number of vertexes.		√
	END	Fixed string (position end)	√

h) Arrow

Line	Content	Description	Import
m	// (space)	Fixed string	
	ARROW	Fixed string	
+1	// (space)	Fixed string	
	Comment	Fixed string	
+2	// (space)	Fixed string	
	LineType	Fixed string	
	,	Fixed character	
	LineWidth	Fixed character	
	,	Fixed character	
	LineColorNo	Fixed string	
	,	Fixed character	
	EdgeType	Fixed character	
+3	// (space)	Fixed string	
	Start Lat	Fixed string	
	,	Fixed character	
	,	Fixed character	
	,	Fixed character	
	Lon	Fixed string	
+4	// (space)	Fixed string	
	End Lat	Fixed string	
	,	Fixed character	
	,	Fixed character	
	Lon	Fixed string	
+5	ARROW	Fixed string	√
+6	Comment	Comment	√
+7	,	Fixed character	√
	Line Width (1(Thin) - 5(Thick))	1	√
	,	Fixed character	√
	Color (White/Black=0,Gray=,Amber=2, Magenta=3,Blue=4,Cyan=5,Green=6, Yellow=7,Orange=8, Red=9)	8	√
	,	Fixed character	√
	Arrow Type -> =0 <- =1 <-> =2	0	√
	,	Fixed character	√
Arrow Size (0(Small) - 2(Large))	0	√	

Line	Content	Description	Import
+8	Start Position Latitude (degrees)	35	√
	,	Fixed character	√
	Start Position Latitude (degrees.minutes)	35.123	√
	,	Fixed character	√
	Start Position Latitude Sign (N/S)	N	√
	,	Fixed character	√
	Start Position Longitude (degrees)	139	√
	,	Fixed character	√
	Start Position Longitude (degrees.minutes)	48.234	√
	,	Fixed character	√
Start Position Longitude Sign (E/W)	E	√	
+9	End Position Latitude (degrees)	38	√
	,	Fixed character	√
	End Position Latitude (degrees.minutes)	35.123	√
	,	Fixed character	√
	End Position Latitude Sign (N/S)	N	√
	,	Fixed character	√
	End Position Longitude (degrees)	142	√
	,	Fixed character	√
	End Position Longitude (degrees.minutes)	48.234	√
	,	Fixed character	√
End Position Longitude Sign (E/W)	E	√	

i) Polygon

Line	Content	Description	Import
m	// (space)	Fixed string	
	POLYGON	Fixed string	
+1	// (space)	Fixed string	
	Comment	Fixed string	
+2	// (space)	Fixed string	
	Lat	Fixed string	
	,	Fixed character	
	,	Fixed character	
	,	Fixed character	
	Lon	Fixed string	
	,	Fixed character	
	Add "END" to the end of vertex.	Fixed string	
+3	POLYGON	Fixed string	√
+4	Comment	Comment	√
+5	Vertex Latitude (degrees)	35	√
	,	Fixed character	√
	Vertex Latitude (degrees.minutes)	35.123	√
	,	Fixed character	√
	Vertex Latitude Sign (N/S)	N	√
	,	Fixed character	√
	Vertex Longitude (degrees)	139	√
	,	Fixed character	√
	Vertex Longitude (degrees.minutes)	48.234	√
	,	Fixed character	√
	Vertex Longitude Sign (E/W)	E	√
+n	Repeat Line +5 for the number of vertexes.		√
	END	Fixed string (position end)	√

j) Circle (polygon)

Line	Content	Description	Import
m	// (space)	Fixed string	
	CIRCLE	Fixed string	
+1	// (space)	Fixed string	
	Comment	Fixed string	
+2	// (space)	Fixed string	
	Base Point-Lat	Fixed string	
	,	Fixed character	
	,	Fixed character	
	,	Fixed character	
	Base Point-Lon	Fixed string	
	,	Fixed character	
	,	Fixed character	
	,	Fixed character	
	Radius[nm]	Fixed string	
+3	CIRCLE	Fixed string	√
+4	Comment	Comment	√
+5	Reference Position Latitude (degrees)	35	√
	,	Fixed character	√
	Reference Position Latitude (degrees.minutes)	35.123	√
	,	Fixed character	√
	Reference Position Latitude Sign (N/S)	N	√
	,	Fixed character	√
	Reference Position Longitude (degrees)	139	√
	,	Fixed character	√
	Reference Position Longitude (degrees.minutes)	48.234	√
	,	Fixed character	√
	Reference Position Longitude Sign (E/W)	E	√
	,	Fixed character	√
	Radius [NM]	2.0	√

k) Ellipse (polygon)

Line	Content	Description	Import
m	// (space)	Fixed string	
	ELLIPSE	Fixed string	
+1	// (space)	Fixed string	
	Comment	Fixed string	
+2	// (space)	Fixed string	
	Base Point-Lat	Fixed string	
	,	Fixed character	
	,	Fixed character	
	,	Fixed character	
	Base Point-Lon	Fixed string	
	,	Fixed character	
	,	Fixed character	
	,	Fixed character	
	Horizontal Radius [nm]	Fixed string	
	,	Fixed character	
	Vertical Radius [nm]	Fixed string	
+3	ELLIPSE	Fixed string	√
+4	Comment	Comment	√
+5	Reference Position Latitude (degrees)	35	√
	,	Fixed character	√
	Reference Position Latitude (degrees.minutes)	35.123	√
	,	Fixed character	√
	Reference Position Latitude Sign (N/S)	N	√
	,	Fixed character	√
	Reference Position Longitude (degrees)	139	√
	,	Fixed character	√
	Reference Position Longitude (degrees.minutes)	48.234	√
	,	Fixed character	√
	Reference Position Longitude Sign (E/W)	E	√
	,	Fixed character	√
	Horizontal Radius [NM]	2.0	√
	,	Fixed character	√
Vertical Radius [NM]	1.5	√	

I) Fan

Line	Content	Description	Import
m	// (space)	Fixed string	
	FAN	Fixed string	
+1	// (space)	Fixed string	
	Comment	Fixed string	
+2	// (space)	Fixed string	
	Base Point-Lat	Fixed string	
	,	Fixed character	
	,	Fixed character	
	,	Fixed character	
	Base Point-Lon	Fixed string	
	,	Fixed character	
	,	Fixed character	
	,	Fixed character	
	Radius [nm]	Fixed string	
	,	Fixed character	
	Start Angle[deg]	Fixed string	
	,	Fixed character	
	End Angle[deg]	Fixed string	
+3	FAN	Fixed string	√
+4	Comment	Comment	√
+5	Reference Position Latitude (degrees)	35	√
	,	Fixed character	√
	Reference Position Latitude (degrees.minutes)	35.123	√
	,	Fixed character	√
	Reference Position Latitude Sign (N/S)	N	√
	,	Fixed character	√
	Reference Position Longitude (degrees)	139	√
	,	Fixed character	√
	Reference Position Longitude (degrees.minutes)	48.234	√
	,	Fixed character	√
	Reference Position Longitude Sign (E/W)	E	√
	,	Fixed character	√
	Radius [NM]	2.0	√
	,	Fixed character	√
Start Radius [deg]	120.0	√	
,	Fixed character	√	
End Radius [deg]	180.0	√	

m) User danger area

Line	Content	Description	Import
m	// (space)	Fixed string	
	DANGER_AREA	Fixed string	
+1	// (space)	Fixed string	
	Comment	Fixed string	
+2	// (space)	Fixed string	
	Lat	Fixed string	
	,	Fixed character	
	,	Fixed character	
	,	Fixed character	
	Lon	Fixed string	
	,	Fixed character	
	Add "END" to the end of vertex.	Fixed string	
+3	DANGER_AREA	Fixed string	√
+4	Comment	Comment	√
+5	Vertex Latitude (degrees)	35	√
	,	Fixed character	√
	Vertex Latitude (degrees.minutes)	35.123	√
	,	Fixed character	√
	Vertex Latitude Sign (N/S)	N	√
	,	Fixed character	√
	Vertex Longitude (degrees)	139	√
	,	Fixed character	√
	Vertex Longitude (degrees.minutes)	48.234	√
	,	Fixed character	√
	Vertex Longitude Sign (E/W)	E	√
+n	Repeat Line +5 for the number of vertexes.		√
	END	Fixed string (position end)	√

n) Text

Line	Content	Description	Import
m	// (space)	Fixed string	
	TEXT	Fixed string	
+1	// (space)	Fixed string	
	Comment	Fixed string	
+2	// (space)	Fixed string	
	Lat	Fixed string	
	,	Fixed character	
	,	Fixed character	
	,	Fixed character	
	Lon	Fixed string	
	,	Fixed character	
+3	Rotation	Fixed string	
	TEXT	Fixed string	√
	,	Fixed character	√
+4	Text	Caution: High flow velocity	√
	Comment	Comment	√
+5	Vertex Latitude (degrees)	35	√
	,	Fixed character	√
	Vertex Latitude (degrees.minutes)	35.123	√
	,	Fixed character	√
	Vertex Latitude Sign (N/S)	N	√
	,	Fixed character	√
	Vertex Longitude (degrees)	139	√
	,	Fixed character	√
	Vertex Longitude (degrees.minutes)	48.234	√
	,	Fixed character	√
	Vertex Longitude Sign (E/W)	E	√
	,	Fixed character	√
	Tuning Angle	0	√
	,	Fixed character	√
Font Size	22	√	

B.10.6 Log Book File

Line	Content	Description	Export
1	//	Fixed string	√
	LOGBOOK SHEET exported by JRC ECDIS.	Fixed string	√
2	//	Fixed string	√
	<<NOTE>>This strings // indicate comment column/cells. You can edit freely.	variable-length string	√
3	//No	Fixed string	√
	,	Fixed character	√
	Date	Fixed string	√
	,	Fixed character	√
	Time	Fixed string	√
	,	Fixed character	√
	,	Fixed character	√
	Time Zone	Fixed string	√
	,	Fixed character	√
	Event	Fixed string	√
	,	Fixed character	√
	Descriptions	Fixed string	√
	,	Fixed character	√
	Latitude	Fixed string	√
	,	Fixed character	√
	,	Fixed character	√
	,	Fixed character	√
	Longitude	Fixed string	√
	,	Fixed character	√
	,	Fixed character	√
	,	Fixed character	√
	POSN1	Fixed string	√
	,	Fixed character	√
	POSN2	Fixed string	√
,	Fixed character	√	
HDG(deg)	Fixed string	√	
,	Fixed character	√	

Line	Content	Description	Export
3	STW(kn)	Fixed string	√
	,	Fixed character	√
	COG(deg)	Fixed string	√
	,	Fixed character	√
	SOG(kn)	Fixed string	√
	,	Fixed character	√
	Av.Speed 4h(G)(kn)	Fixed string	√
	,	Fixed character	√
	Av.Speed 24h(G)(kn)	Fixed string	√
	,	Fixed character	√
	Depth(m)	Fixed string	√
	,	Fixed character	√
	Chart	Fixed string	√
	,	Fixed character	√
	Set(deg)	Fixed string	√
	,	Fixed character	√
	Drift(kn)	Fixed string	√
	,	Fixed character	√
	Wind Dir.(deg)	Fixed string	√
	,	Fixed character	√
	Wind Speed(kn)	Fixed string	√
	,	Fixed character	√
	Beaufort Scale	Fixed string	√
	,	Fixed character	√
	Wave Dir.(deg)	Fixed string	√
	.	Fixed character	√
	Wave Height(m)	Fixed string	√
	,	Fixed character	√
	Voyage DIST(G)(NM)	Fixed string	√
	,	Fixed character	√
	Voyage DIST(W)(NM)	Fixed string	√
	.	Fixed character	√

Line	Content	Description	Export
3	Air Pressure(hPa)	Fixed string	√
	,	Fixed character	√
	Air Temperature(deg C)	Fixed string	√
	,	Fixed character	√
	Water Temperature(deg C)	Fixed string	√
	,	Fixed character	√
	Weather Condition	Fixed string	√
	,	Fixed character	√
	Engine Rev.(RPM)	Fixed string	√
	,	Fixed character	√
	Comment	Fixed string	√
4	No.	0001	√
	,		√
	Date (LMT)	2014/01/17	√
	,		√
	Time (LMT)	08:45:24	√
	,		√
	Time Zone Sign	+	√
	,		√
	Time Zone	09:00	√
	,		√
	Event Type	Manual Position Fix	√
	,		√
	Event Details		√
	,		√
	Latitude	35	√
	,		√
		35.123	√
,		√	
	N	√	
,		√	

Line	Content	Description	Export
4	Longitude	139	√
	,		√
		48.234	√
	,		√
		E	√
	,		√
	Position 1 Source	GPS 1	√
	,		√
	Position 2 Source	GPS 2	√
	,		√
	Ship's Heading	123.4	√
	,		√
	Water Ship Speed	12.3	√
	,		√
	Ground Course	123.5	√
	,		√
	Ground Ship Speed	12.4	√
	,		√
	Average Ship Speed In 4h	12.0	√
	,		√
	Average Ship Speed In 24h	13.2	√
	,		√
	Depth Of Water	123.9	√
	,		√
	Chart Name That Caused The Event	JP34OBJ	√
	,		√
	Flow Direction	123.4	√
	,		√
	Flow Speed	12.4	√
	,		√
	Wind Bearing	234.5	√
	,		√

Line	Content	Description	Export
4	Wind Speed	10.3	√
	,		√
	Beaufort Scale	Hurricane	√
	,		√
	Wave Direction	123.4	√
	.		√
	Wave Height	2.1	√
	,		√
	Ground Running Distance	12345.67	√
	,		√
	Water Running Distance	12300.23	√
	.		√
	Atmospheric Pressure	1003	√
	,		√
	Temperature	23.4	√
	,		√
	Water Temperature	20.3	√
	,		√
	Weather Condition	Blue sky	√
	,		√
Engine Speed	135.6	√	
,		√	
Comment		√	
n	Repeat Line 4 the number of times of events.		√

Software License Agreement

This Software License Agreement is made and entered between the user who purchased a product of JAN-7201S/9201S and Japan Radio Co., Ltd. (hereinafter referred to as "JRC") with regard to the license to use the software in the product series.

- You have purchased a device that uses software licensed from Microsoft License in the U.S. and Trend Micro Incorporated to JRC. The software which was developed by Microsoft and Trend Micro and installed in the device along with the printed documentation attached to it and its online or electronic documents (hereinafter collectively referred to as the "Software") are protected by international laws and conventions in relation to the protection of intellectual properties.
The licensed Software has not been sold to you and all rights in and to the Software are reserved.
- **If you do not agree to execute this License Agreement, you will not be allowed to use the device or copy the Software. If you do not agree to the provisions and terms hereof, you are requested to immediately inform us of your intention to return the device before you start to use it so that JRC can repay you the amount you have paid for it. By using the Software in the state as installed in the device or in any other way, you agree to the provisions of this License Agreement (or confirm your prior agreement).**
- **Conditions of the license shall be stipulated as follows:**
 - The Software shall only be licensed for the use in the state as installed in the device you have purchased.
 - **Indemnification: The Software itself is not free from defects. JRC has defined on its own account how to use the Software installed in JRC's devices. For this reason, Microsoft and Trend Micro trust JRC to conduct sufficient tests to determine whether the Software is suitable for such usage as a prerequisite for the use of the Software.**
 - **The Software is provided with no warranties whatsoever: The Software is provided as is and with all faults. You shall bear all the risks whether you can obtain satisfactory quality, performance and accuracy and it shall be your responsibility to make efforts to ensure them including eliminating errors. In addition, there is no warranty in the event of prevention from using the Software or in the case of infringement of any right arising from using the Software. Even if you can have any warranty in relation to the device or the Software, such warranty is not the one provided by Microsoft or Trend Micro, and therefore such warranty shall not bind either Microsoft or Trend Micro.**
 - Java support: The Software may include support of programs written in the Java language. The Java technology is not free from defects and is not designed or manufactured for the purpose of use or resell as online controlling equipment for the use in any dangerous environment requiring preparation of safety device in case of an emergency such as in operation of nuclear device, navigation or telecommunication system for aircrafts, air traffic control, life support machine or weapon systems in which failure of the Java technology may directly lead to an event which causes death or serious injury or environmental damage.
This statement of disclaimer of liability is the obligation of Microsoft under the contract between Microsoft and Sun Microsystems.

-
- **Limitation of Liability:** Except to the extent prohibited by law, Microsoft shall not be liable for any indirect damages, special damages, consequential damages or incidental damages arising from or in relation to the performance or use of the Software. This limitation of liability shall apply even in the case any remedy for damages may not fulfill its essential purpose. In any event, Microsoft shall not liable for any damages exceeding the amount equal to 250 US\$.
 - **Limitation of Liability:** Trend Micro shall not be liable for any consequential damages, incidental damages, or loss of profit arising from the use of the software activation code or instruction manuals. In any event, Trend Micro's total liability shall be limited to a 100% of the amount paid by you for the service rendered during three months immediately before the damage occurred.
 - **Restriction of reverse engineering, decompiling and disassembling:** Except in cases explicitly permitted by applicable laws regardless of the restriction hereunder, you shall not reverse engineer, decompile or disassemble the Software.
 - **Export control:** You acknowledge that the country of origin of the Software is the United States of America. You agree to comply with export control laws and regulations of the United States of America as well as both domestic laws of the United States of America and international laws applicable to the Software including regulations issued by the U.S. Government or other governments in relation to end users, end use and country of destination.
For additional information on export of the Software, refer to the website: <http://www.microsoft.com/en-us/exporting/default.aspx>.

Font License Agreement

This product uses Migu font (<http://mix-mplus-ipa.sourceforge.jp/migu/>) to display characters on the screen. Migu font data is distributed from the URL stated above. Migu font is distributed in compliance with "IPA Font License Agreement v1.0" (http://ipafont.ipa.go.jp/ipa_font_license_v1.html). This product loaded with the Migu font is also in compliance with "IPA Font License Agreement v1.0." You may use this product under the agreement to the provisions of "IPA Font License Agreement v1.0." You have the right to change the font used for the display of this product from Migu font to IPA font. However, there is no need to change the Migu font to IPA font in the specifications of this product. Moreover, this product is designed to provide the display which is optimized for using Migu font. Note that using IPA font for the display may cause a problem of compatibility of font data with regard to the form of some characters resulting in degradation of the display on the screen. If you desire to change from Migu font to IPA font, consult with our service agent.

IPA Font License Agreement v1.0

The Licensor provides the licensed Program (as defined in Article 1 below) under the terms of this License Agreement (“Agreement”). Any use, reproduction or distribution of the I Program, or any exercise of rights under this Agreement by a Recipient (as defined in Article 1 below) constitutes the Recipient's acceptance of this Agreement.

Article 1 (Definitions)

In this Agreement, the following terms set forth in each item shall be defined as therein.

1. “Digital Font Program” shall mean a computer program containing, or used to render or display fonts.
2. “Licensed Program” shall mean a Digital Font Program licensed by the Licensor under this Agreement.
3. “Derived Program” shall mean a Digital Font Program created as a result of a modification, addition, deletion, replacement or any other adaptation to or of a part or all of the licensed Program, and includes a case where a Digital Font Program newly created by retrieving font information from a part or all of the licensed Program or Embedded Fonts from a Digital Document File with or without modification of the retrieved font information.
4. “Digital Content” shall mean products provided to end users in the form of digital data, including video content, motion and/or still pictures, TV programs or other broadcasting content and products consisting of character text, pictures, photographic images, graphic symbols and/or the like.
5. “Digital Document File” shall mean a PDF file or other Digital Content created by various software programs in which a part or all of the licensed Program becomes embedded or contained in the file for the display of the font (“Embedded Fonts”). Embedded Fonts are used only in the display of characters in the particular Digital Document File within which they are embedded, and shall be distinguished from those in any Digital Font Program, which may be used for display of characters outside that particular Digital Document File.
6. “Computer” shall include a server in this Agreement.
7. “Reproduction and Other Exploitation” shall mean reproduction, transfer, distribution, lease, public transmission, presentation, exhibition, adaptation and any other exploitation.
8. “Recipient” shall mean anyone who receives the licensed Program under this Agreement, including one that receives the licensed Program from a Recipient.

Article 2 (Grant of License)

The Licensor grants to the Recipient a license to use the licensed Program in any and all countries in accordance with each of the provisions set forth in this Agreement. However, any and all rights underlying in the licensed Program shall be held by the Licensor. In no sense is this Agreement intended to transfer any right relating to the licensed Program held by the Licensor except as specifically set forth herein or any right relating to any trademark, trade name, or service mark to the Recipient.

-
1. The Recipient may install the licensed Program on any number of Computers and use the same in accordance with the provisions set forth in this Agreement.
 2. The Recipient may use the licensed Program, with or without modification in printed materials or in Digital Content as an expression of character texts or the like.
 3. The Recipient may conduct Reproduction and Other Exploitation of the printed materials and Digital Content created in accordance with the preceding Paragraph, for commercial or non-commercial purposes and in any form of media including but not limited to broadcasting, communication and various recording media.
 4. If any Recipient extracts Embedded Fonts from a Digital Document File to create a Derived Program, such Derived Program shall be subject to the terms of this agreement.
 5. If any Recipient performs Reproduction or Other Exploitation of a Digital Document File in which Embedded Fonts of the licensed Program are used only for rendering the Digital Content within such Digital Document File then such Recipient shall have no further obligations under this Agreement in relation to such actions.
 6. The Recipient may reproduce the licensed Program as is without modification and transfer such copies, publicly transmit or otherwise redistribute the licensed Program to a third party for commercial or non-commercial purposes ("Redistribute"), in accordance with the provisions set forth in Article 3 Paragraph 2.
 7. The Recipient may create, use, reproduce and/or Redistribute a Derived Program under the terms stated above for the licensed Program: provided, that the Recipient shall follow the provisions set forth in Article 3 Paragraph 1 when Redistributing the Derived Program.

Article 3 (Restriction)

The license granted in the preceding Article shall be subject to the following restrictions:

1. If a Derived Program is Redistributed pursuant to Paragraph 4 and 7 of the preceding Article, the following conditions must be met :
 - (1) The following must be also Redistributed together with the Derived Program, or be made available online or by means of mailing mechanisms in exchange for a cost which does not exceed the total costs of postage, storage medium and handling fees:
 - (a) a copy of the Derived Program; and
 - (b) any additional file created by the font developing program in the course of creating the Derived Program that can be used for further modification of the Derived Program, if any.
 - (2) It is required to also Redistribute means to enable recipients of the Derived Program to replace the Derived Program with the licensed Program first released under this License (the "Original Program"). Such means may be to provide a difference file from the Original Program, or instructions setting out a method to replace the Derived Program with the Original Program.
 - (3) The Recipient must license the Derived Program under the terms and conditions of this Agreement.
 - (4) No one may use or include the name of the licensed Program as a program name, font name or file name of the Derived Program.

-
-
- (5) Any material to be made available online or by means of mailing a medium to satisfy the requirements of this paragraph may be provided, verbatim, by any party wishing to do so.
 2. If the Recipient Redistributes the licensed Program pursuant to Paragraph 6 of the preceding Article, the Recipient shall meet all of the following conditions:
 - (1) The Recipient may not change the name of the licensed Program.
 - (2) The Recipient may not alter or otherwise modify the licensed Program.
 - (3) The Recipient must attach a copy of this Agreement to the licensed Program.
 3. This licensed Program is provided by the licensor “as is” and any expressed or implied warranty as to the licensed Program or any derived program, including, but not limited to, warranties of title, non-infringement, merchantability, or fitness for a particular purpose, are disclaimed. In no event shall the licensor be liable for any direct, indirect, incidental, special, extended, exemplary, or consequential damages (including, but not limited to; procurement of substituted goods or service; damages arising from system failure; loss or corruption of existing data or program; lost profits), however caused and on any theory of liability, whether in contract, strict liability or tort (including negligence or otherwise) arising in any way out of the installation, use, the reproduction or other exploitation of the licensed Program or any derived program or the exercise of any rights granted hereunder, even if advised of the possibility of such damages.
 4. The Licensor is under no obligation to respond to any technical questions or inquiries, or provide any other user support in connection with the installation, use or the Reproduction and Other Exploitation of the licensed Program or Derived Programs thereof.

Article 4 (Termination of Agreement)

1. The term of this Agreement shall begin from the time of receipt of the licensed Program by the Recipient and shall continue as long as the Recipient retains any such licensed Program in any way.
2. Notwithstanding the provision set forth in the preceding Paragraph, in the event of the breach of any of the provisions set forth in this Agreement by the Recipient, this Agreement shall automatically terminate without any notice. In the case of such termination, the Recipient may not use or conduct Reproduction and Other Exploitation of the licensed Program or a Derived Program: provided that such termination shall not affect any rights of any other Recipient receiving the licensed Program or the Derived Program from such Recipient who breached this Agreement.

Article 5 (Governing Law)

1. IPA may publish revised and/or new versions of this license. In such an event, the Recipient may select either this Agreement or any subsequent version of the Agreement in using, conducting the Reproduction and Other Exploitation of, or Redistributing the licensed Program or a Derived Program. Other matters not specified above shall be subject to the Copyright Law of Japan and other related laws and regulations of Japan.
2. This Agreement shall be construed under the laws of Japan.

アスベストは使用していません
Not use the asbestos

For further information, contact:



Japan Radio Co., Ltd.

Since 1915

URL Head office : <http://www.jrc.co.jp/eng/>

Marine Service Department

1-7-32 Tatsumi, Koto-ku, Tokyo 135-0053, Japan

e-mail : tmsc@jrc.co.jp

One-call : +81-50-3786-9201

ISO 9001, ISO 14001 Certified