



ALPHATRON
Marine



Alphatron LT-3100S GMDSS Iridium

Amendment to Lars Thrane manual

www.alphatronmarine.com



Contents

I.	Preface.....	3
	Revision History.....	3
II.	About the amendment.....	3
III.	Disclaimer.....	3
IV.	Safety Information.....	4
V.	Warranty.....	5
VI.	Service & Repair.....	6
	Appendices.....	7
	Appendix A: Alphatron Outline Drawing - LT-3110S Control Unit (Flush Mount).....	7
	Appendix B: Alphatron Outline Drawing - LT-3110S Control Unit (Bracket Mount).....	10
	Appendix C: Alphatron Part Numbers – LT3100S.....	12
	Basic set (in-the-box).....	12
	Accessories.....	12



I. Preface

This is an amendment to the Lars Thrane LT-3100S GMDSS Iridium Installation and Operation Manual, hereafter referred to as Lars Thrane manual.

- Thoroughly read this amendment and the Lars Thrane manual before installation and operation of the equipment.
- We recommend keeping this amendment and the Lars Thrane manual nearby the equipment to ensure ready access to it.

Contact the Alpatron Marine dealer for copies of this amendment and/or the Lars Thrane manual.

Revision History

Revision No.	Date	Description	Author
1.0	01-03-2021	First release	J. Kreeft
1.04	19-03-2021	Update Information Lars Thrane	M. Bode
1.05	06-05-2021	Update Information Lars Thrane (see Record of Revisions)	M. Bode

II. About the amendment

This amendment contains information on Alpatron Marine modifications and part numbers.

III. Disclaimer

Any responsibility or liability for loss or damage in connection with the use of this equipment and the accompanying documentation is disclaimed by Alpatron Marine. The information in this amendment and Lars Thrane manual is provided for information purposes only, is subject to change without notice, and may contain errors or inaccuracies. Documentation issued by Alpatron Marine and Lars Thrane are periodically revised and updated. Anyone relying on this information should acquire the most current version. Alpatron Marine is not responsible for the content or accuracy of any translations or reproductions, in whole or in part, of the documentation from any other source.

IV. Safety Information

Failure to comply with the precautions or with dangers, warnings, and cautions in this amendment and Lars Thrane manual violates safety standards of design, manufacture, and intended use of the equipment. Alpatron Marine assumes no liability for the customer's failure to comply with these requirements.

To safely install, service, repair and operate the equipment, the following dangers, warnings, and cautions must be adhered to.



WARNING

Keep away from live circuits. Otherwise, it may cause a fire, or you may suffer an electrical shock.



WARNING

Do not disassemble or modify the equipment. Otherwise, it may cause a fire, or you may suffer an electrical shock.



WARNING

Do not insert or remove the power cord or operate switches with a wet hand. Otherwise, you may suffer an electrical shock.



WARNING

Do not scratch, damage, modify, heat, pull, excessively bend, or heavily load the power supply cables. Otherwise, it may cause a fire, or you may suffer an electrical shock.



WARNING

Immediately turn off the power and disconnect the power supply cable if the equipment is generating any smoke or odour, or is overheated. Immediately inform your local service agent of the symptom to have it repaired. Prolonged operation under such a condition can cause a fire or electric shock.



V. Warranty

To not to adversely affect the warranty, the following notices must be adhered to.

NOTICE Operating personnel must not remove equipment covers. Only personnel trained and certified must make component replacement and internal adjustment.

NOTICE Non-compliance with the installation, operation and maintenance requirements may void the warranty.

NOTICE Do not disassemble or modify the equipment. Failure to observe this instruction may cause equipment failure, and it will void the warranty.

NOTICE Any modification to this equipment without prior written permission from Alpatron Marine will void the warranty.

NOTICE Installation of this equipment shall only be done by a certified installation company approved by either Alpatron Marine or by an official Alpatron Marine distributor. Acting otherwise will void the warranty.

NOTICE The equipment must be installed in accordance with the prescribed installation methods. Acting otherwise will void the warranty.

NOTICE When cleaning the surface, do not use any organic solvent such as thinner or benzene. Otherwise, the paint and markings on the surface may get damaged. For cleaning the surface, remove the dust and debris and wipe with a clean dry cloth.

Contact the Alpatron Marine dealer regarding the terms of the warranty.



VI. Service & Repair

If the equipment for some reason does not work as described in the Lars Thrane manual, contact the distributor or dealer, from where the equipment was originally bought. The distributor or dealer will have experience and know-how to assist with further technical support and troubleshooting.

All information that will get back to Alpatron Marine and Lars Thrane, either directly or indirectly, will be handled with confidentiality. End-user sensitive data will not be shared with any third party without prior written acceptance from the involved parties.

NOTE Make sure that the equipment is installed, as described in the Lars Thrane manual, before making contact to the distributor or dealer for further assistance.

Appendices

Appendix A: Alpatron Outline Drawing - LT-3110S Control Unit (Flush Mount)

Front View

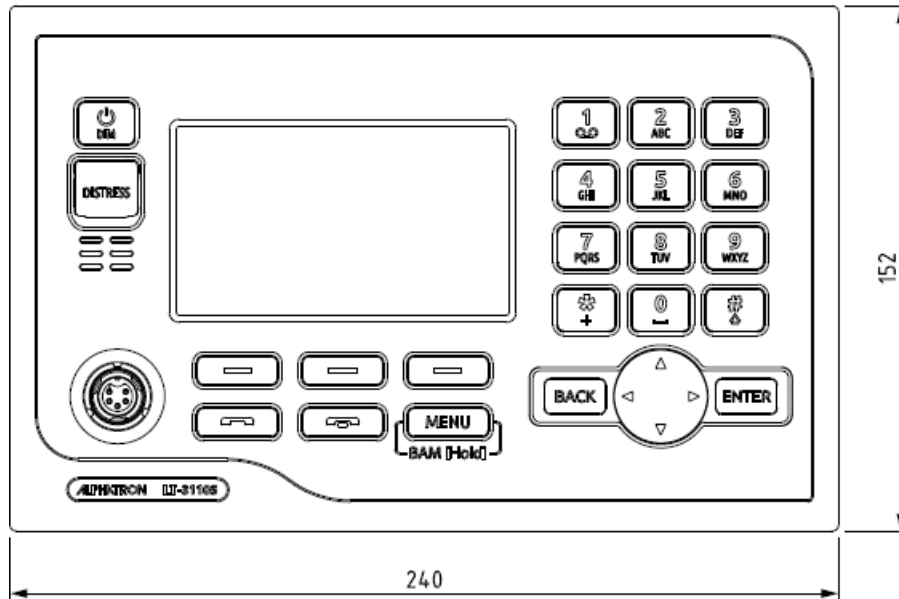

Bottom View

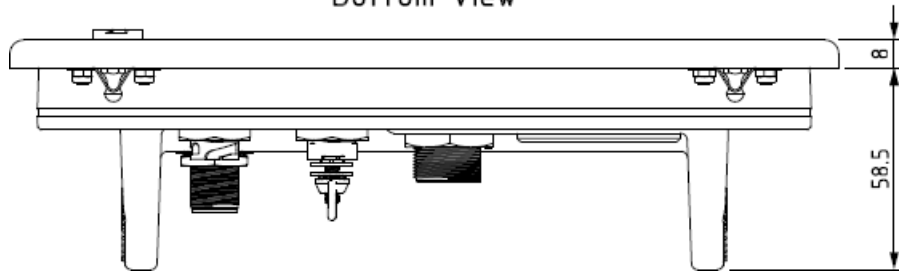

Back View

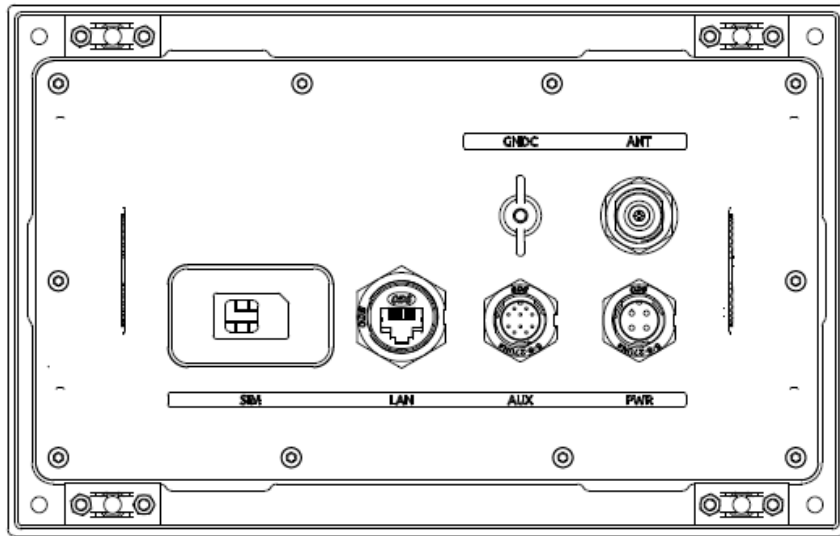

Cut-out

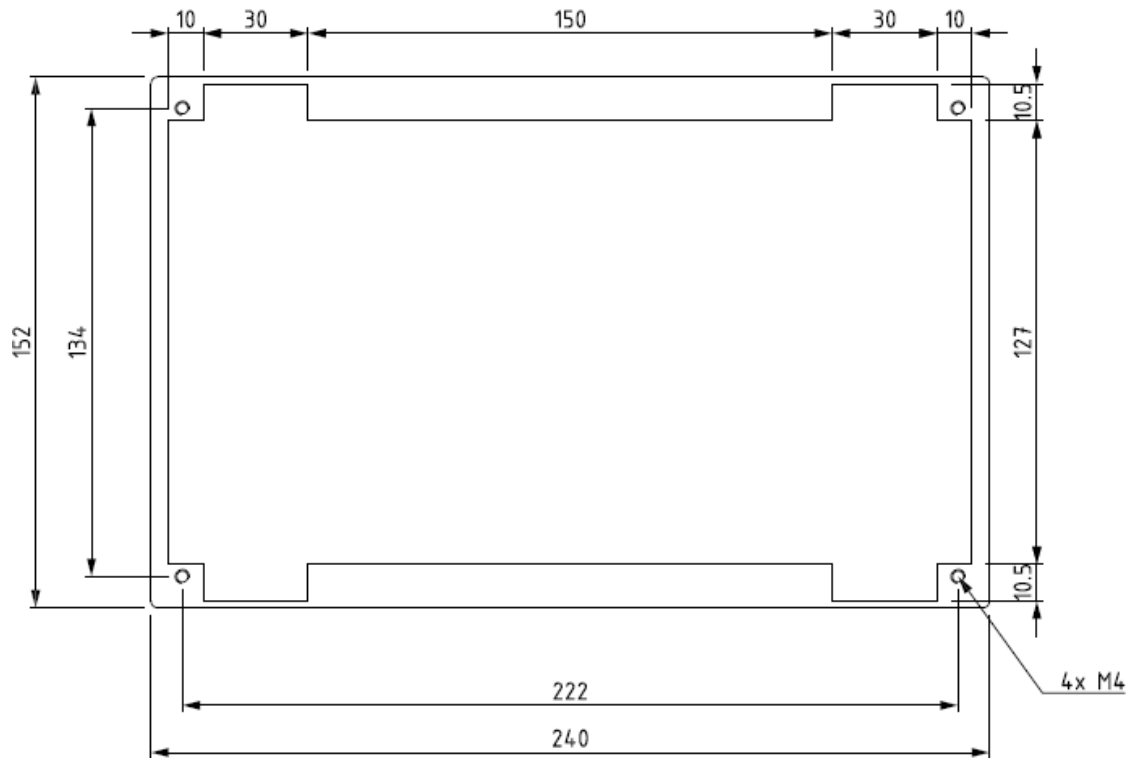

Side View

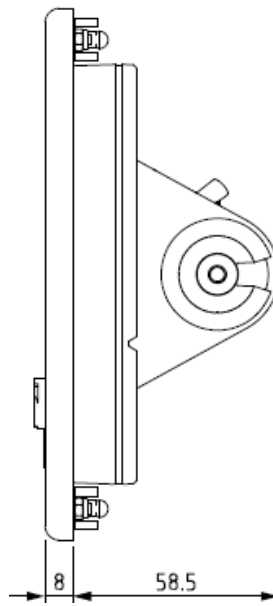

Appendix B: Alpatron Outline Drawing - LT-3110S Control Unit (Bracket Mount)

Front View

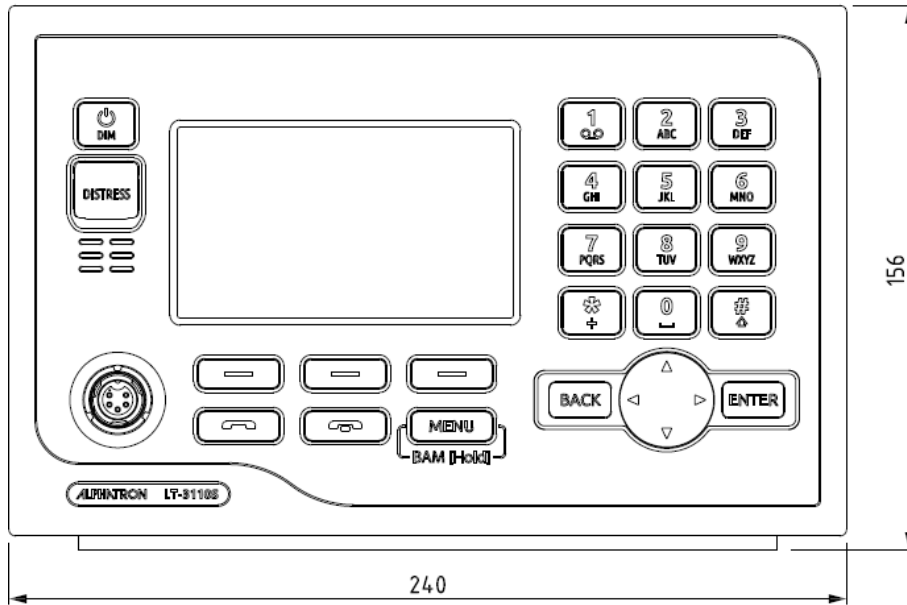

Bottom View

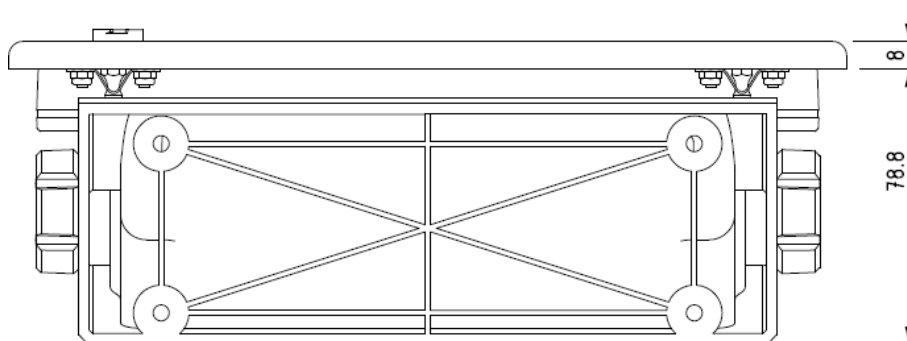

Back View

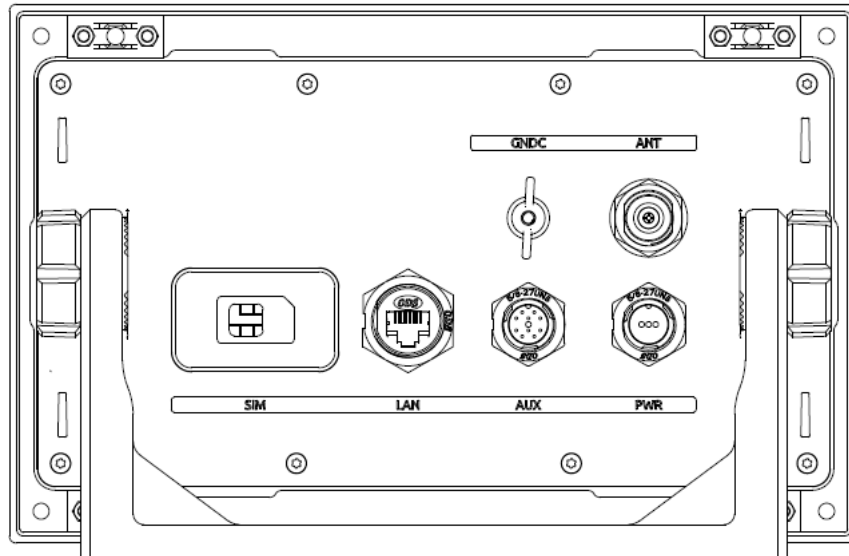

Side View

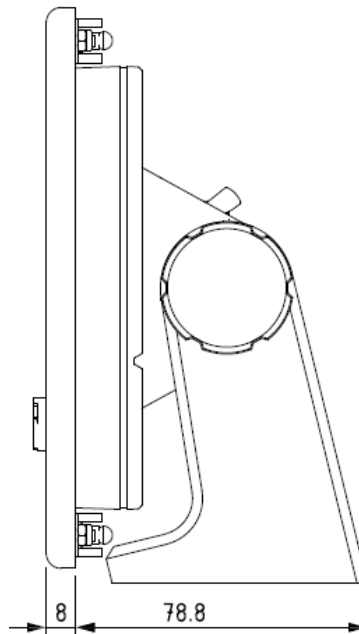

Appendix C: Alphasat Part Numbers – LT3100S

Basic set (in-the-box)

The Alphasat LT-3100S GMDSS Iridium Basic set (P/N: G-007760) consists of following parts:

1. LT-3110S Control Unit (P/N: G-008364)
2. LT-3120 Handset (P/N: G-007781)
3. LT-3121 Handset cradle (P/N: G-007782)
4. LT-3130 Antenna Unit (P/N: G-007783)
5. Bracket Mount, LT-3110S Control Unit
6. Power Cable, 3m (P/N: G-007773)
7. 4 x Stainless steel A4 screws (for Bracket Mount, LT-3110S Control Unit)
8. 2 x Stainless steel A4 screws (for Handset cradle)
9. Alphasat LT-3100S GMDSS Iridium – Amendment to Lars Thrane Installation and Operation Manual
10. Lars Thrane Unit Test Sheets
11. Lars Thrane LT-3100S GMDSS Iridium - Installation and Operation Manual

Accessories

The following parts are not part of the basic set and can be ordered separately:

GMDSS partsLT-3140S Interface Unit (P/N: G-007763)

1. LT-3150S Alarm Panel (incl. 25 m cable) (P/N: G-007764)
2. LT-3160S Printer Adapter (incl. 25 m cable) (P/N: G-007765)

SSAS parts

1. SSAS Alert Button (incl. 50 m cable) (P/N: G-007766)
2. SSAS Test Button (incl. 50 m cable) (P/N: G-007767)

Mounts

1. Bracket Mount (1.5" to 2.5" tube), Antenna Unit with cable hose (P/N: G-007771)
2. Pole Mount (1.5" tube), Antenna Unit (P/N: G-007772)

Cables and connectors

1. G-007774 Aux Cable, 3m
2. G-007775 RG-58 Coaxial cable Ø4.9mm, 10m
3. G-007776 RG-58 Coaxial cable Ø4.9mm, 25m
4. G-007777 RG-213 Coaxial Cable Ø10.3mm 10m
5. G-007778 RG-213 Coaxial Cable Ø10.3mm 25m
6. G-007779 RG-213 Coaxial Cable Ø10.3mm 50m
7. N connector (male) for Coaxial Cable Ø4.9mm
8. N connector (male) for Coaxial Cable Ø10.3mm

User & Installation Manual

LT-3100S GMDSS Satellite Communications System

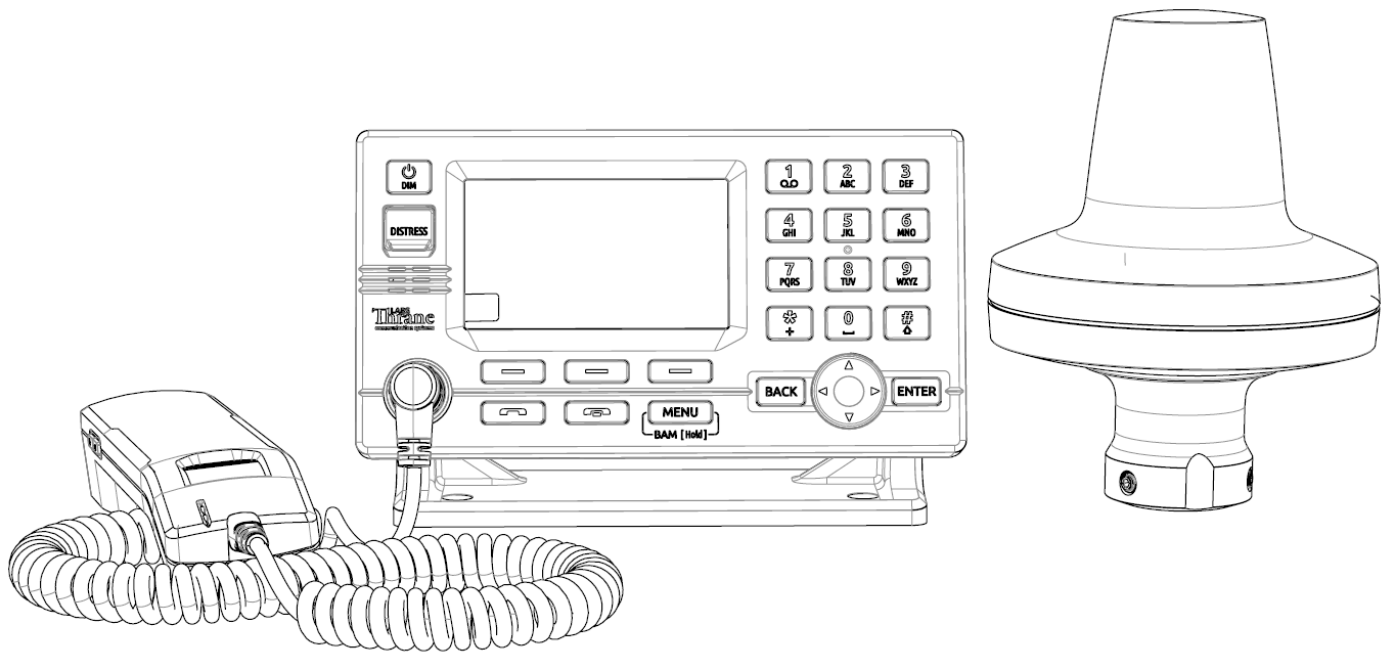

Document Number: 95-102251 Rev. 1.05

Release date: May 06, 2021

Copyright © Lars Thrane A/S

Denmark

ALL RIGHTS RESERVED

This Document is of © copyright to Lars Thrane A/S. It contains proprietary information, which is disclosed for information purposes only. The contents of this document shall not in whole or in part be used for any other purpose without prior permission from Lars Thrane A/S.

Disclaimer

Any responsibility or liability for loss or damage in connection with the use of this product and the accompanying documentation is disclaimed by Lars Thrane A/S. The information in this manual is provided for information purposes only, is subject to change without notice, and may contain errors or inaccuracies. Manuals issued by Lars Thrane A/S are periodically revised and updated. Anyone relying on this information should acquire the most current version e.g. from Lars Thrane A/S. Lars Thrane A/S is not responsible for the content or accuracy of any translations or reproductions, in whole or in part, of this manual from any other source.

Copyright

© 2021 Lars Thrane A/S. All rights reserved.

Disposal

Old electrical and electronic equipment marked with this symbol can contain substances hazardous to human beings and the environment. Never dispose these items together with unsorted municipal waste (household waste). In order to protect the environment and ensure the correct recycling of old equipment as well as the re-utilization of individual components, use either public collection or private collection by the local distributor of old electrical and electronic equipment marked with this symbol. Contact the local distributor or dealer for information about what type of return system to use.



IMO and SOLAS

The equipment described in this manual is intended for use on commercial marine and leisure vessels. The equipment is covered by the International Maritime Organization (IMO) and Safety of Life at Sea (SOLAS) regulations.

 **Safety Instructions for the Installer**

The following safety instructions must be observed during all phases of operation, installation, service and repair of this equipment. Failure to comply with these precautions or with specific warnings elsewhere in this manual violates safety standards of design, manufacture and intended use of the equipment.

Lars Thrane A/S assumes no liability for the customer's failure to comply with these requirements.

Instructions for the Installer

 **WARNING - Product installation**

To ensure correct performance of this equipment, it is strongly recommended that professionals with expertise, properly trained, and likewise authorized within the industry is completing the installation.

 **WARNING - Explosive atmosphere**

Do not operate the equipment in the presence of flammable gases or fumes. Operation of any electrical equipment in such an environment constitutes a definite hazard.

 **WARNING – Turn off power switch**

Turn off the main power switch before installing the equipment described in this manual. Do not connect or disconnect equipment when the main power switch is on.

 **WARNING - Compass safe distance**

The compass safe distance for standard and steering compasses is 1.0 m (3.3 ft) and 0.9 m (3.0 ft) respectively. Observe these distances to prevent interference to a magnetic compass.

 **WARNING – Input Power**

The input voltage range is: 12-24 VDC.

 **WARNING – Power supply protection**

Make sure that the power supply is adequately protected by a fuse or an automatic circuit breaker when installing the equipment:

- LT-3110S Control Unit (max. 15.0 A)
- LT-3140S Interface Unit (max. 5.0 A)

 **WARNING – DC circuit breaker**

DC circuit breaker must be used as ON/OFF switch for the Control Unit and Interface Unit.

 **WARNING – Overcurrent protective**

Overcurrent protective devices used as safeguard (specific to IEC 62368-1) - Lars Thrane A/S has the responsibility of use of non-IEC approved fuses in the equipment.

If the safety precautions and warnings on this site are not followed, warranty will be void.

Safety Instructions for the Operator

The following safety instructions must be observed during all phases of operation, installation, service and repair of this equipment. Failure to comply with these precautions or with specific warnings elsewhere in this manual violates safety standards of design, manufacture and intended use of the equipment.

Lars Thrane A/S assumes no liability for the customer's failure to comply with these requirements.

Instructions for the Operator

WARNING – Do not disassemble

Do not disassemble or modify this equipment. Fire, electrical shock, or serious injury can result.

WARNING – Keep away from live circuits

Operational personnel must not remove product enclosure. Do not service the equipment with the communication cable connected. Always disconnect and discharge unit, cable and circuits before touching them.

WARNING - Permanent watch

In case of smoke or water leaks into the equipment, immediately turn off the power. Continued use of the equipment can cause fire or electrical shock. Keep access and permanent watch of the equipment in order to prevent any unwanted escalation.

WARNING – DC mains connector

The DC mains connector is to be used as the disconnection device to isolate the equipment from the mains supply.

IMPORTANT - Safety distance

The safety distance from the LT-3130 Antenna Unit, when the LT-3130 Antenna Unit is powered and transmitting, is 0.1 m (0.3 ft), in order to comply with the regional regulations.

Always keep this safety distance to the LT-3130 Antenna Unit to avoid any serious injury.

If the safety precautions and warnings on this site are not followed, warranty will be void.



IMPORTANT – FCC Compliance Note:

This equipment has been tested and found to comply with the limits for a Class B digital device, pursuant to part 15 of the FCC Rules. These limits are designed to provide reasonable protection against harmful interference in a residential installation. This equipment generates, uses and can radiate radio frequency energy and, if not installed and used in accordance with the instructions, may cause harmful interference to radio communications. However, there is no guarantee that interference will not occur in a particular installation. If this equipment does cause harmful interference to radio or television reception, which can be determined by turning the equipment off and on, the user is encouraged to try to correct the interference by one of the following measures:

- Reorient or relocate the receiving antenna.
- Increase the separation between the equipment and the receiver.
- Connect the equipment into an outlet on a circuit different from that to which the receiver is connected.
- Consult the dealer or an experienced radio/TV technician for help.

This product does not contain any user-serviceable parts.

Repairs should only be made by an authorized Lars Thrane A/S service center. Unauthorized repairs or modifications could result in permanent damage to the equipment and void your warranty and your authority to operate this device under Part 15 regulations.



IMPORTANT – FCC Compliance Note:

This device complies with the GMDSS provisions of part 80 of the FCC rules.



IMPORTANT – Innovation, Science and Economic Development Canada Compliance Note:

This device complies with Innovation, Science and Economic Development Canada license-exempt RSS standard(s). Operation is subject to the following two conditions: (1) this device may not cause interference, and (2) this device must accept any interference, including interference that may cause undesired operation of the device.

Required information for the reader

Throughout this document, essential information will be presented to the reader. The following text (emphasized) has the following meaning and/or implication:

WARNING: A 'Warning' is an Operation or Service procedure that, if not avoided, may cause a hazard situation, which could result in personnel death or serious injury.

IMPORTANT: Text marked 'Important' provides essential information to the reader and is key information to the user for the equipment to work properly. Damage to the equipment can occur if instructions are not followed.

NOTE: A 'Note' provides essential information to the reader.

About this manual

Intended readers

This is a User & Installation Manual for LT-3100S GMDSS Satellite Communications System, or LT-3100S GMDSS system. The manual is intended for installers and service personnel, as well as operations of the system (~users).

Personnel installing or servicing the system should be professionals with technical expertise, properly trained, and likewise authorized.

All safety instructions and guidelines in this manual must be observed. The safety instructions are listed in the beginning of the manual. The guidelines are to be found in the separate chapters, where it is needed.

Software versions

This manual is applicable to the following software:

Software Versions		
Description	P/N	Version
LT-3100S GMDSS System	71-101828	1.04R

Table 1: Software Versions

IMPORTANT: The latest software released by Lars Thrane A/S must always be used for new installations of the LT-3100S GMDSS Systems and must be updated during a Radio Survey to ensure the best possible performance of the system and services.

NOTE: The latest LT-3100S GMDSS Software and Release Notes can always be downloaded from the Lars Thrane A/S website. Please contact Lars Thrane A/S for details about future software releases and features.

Record of Revisions

Rev.	Description	Release Date	Initials
1.00	Original document.	December 05, 2020	PT
1.01	Editorial corrections.	December 07, 2020	PT
1.02	Editorial corrections.	December 09, 2020	PT
1.03	The following sections are updated: <ul style="list-style-type: none"> • <i>App. H - Specifications</i>: LT-3130 Antenna Unit operational temperature for 12 VDC and 24 VDC input power. 	December 15, 2020	CT
1.04	The following sections are updated: <ul style="list-style-type: none"> • <i>Distress Alert Relay, Maritime Safety Information (MSI), and Safety Messaging</i>: MSI and Safety Message Distress or Urgency priority can now be muted via dialog box (pop up) • <i>Maritime Safety Information (MSI)</i>: Added clarification to MSI message reception • <i>System Submenus</i>: Changed adjustable steps for audio and display brightness 	February, 08, 2021	KTL
1.05	The following sections are added: <ul style="list-style-type: none"> • <i>Installation and Mounting, Pole Mount (2.0" pipe, 53.0 mm), Antenna Unit</i> • <i>Galvanic Isolated Power Supply</i> • <i>GMDSS Submenu, Printer Settings</i> • <i>System Services, Data (Modem Data & SMS)</i> • <i>Web server, Messages (MSI)</i> • <i>Web server, Configuration, Authentication (MSI login)</i> • <i>App. Q - Outline Drawing: Pole Mount (2.0" pipe, 53.0 mm), Antenna Unit</i> The following sections are updated: <ul style="list-style-type: none"> • <i>Installation and Mounting, LT-3130 Antenna Unit</i> • <i>Activating the System, Installation Wizard</i> • <i>Change of Hardware and Software, Change of Hardware & Service Wizard</i> • <i>GMDSS Services, Distress Alert & Distress Call</i> • <i>GMDSS Submenu, Terminal Test</i> • <i>System Submenus, Settings (Audio & Certificates)</i> • <i>System Submenus, System (System Info)</i> • <i>App. B - Bridge Alert Management (BAM)</i> 	May, 06, 2021	KTL

	<p>GUI/graphics in the following sections are updated:</p> <ul style="list-style-type: none">• <i>System Overview</i>• <i>GMDSS Submenu, MSI Settings (Coastal Warning Areas & Coastal Warning Services), SES Information & Terminal Test</i>• <i>System Submenus, Phone, Settings & System</i> <p>The 'Position Status' window located in (MENU -> System) has been renamed to 'GNSS Status'.</p>		
--	---	--	--

Table of Contents

Introduction	1
Application and Limitations	2
Unpacking (in-the-box)	3
Inspection	3
Accessories	4
GMDSS parts	4
SSAS parts	4
Mounts	4
Cable and connectors	5
System Overview	6
Installation and Mounting	7
LT-3110S Control Unit	7
LT-3120 Handset	10
LT-3121 Cradle	11
LT-3130 Antenna Unit	12
LT-3140S Interface Unit	20
LT-3150S Alarm Panel	21
LT-3160S Printer Adapter	23
Bracket Mount (1.5" to 2.5" pipe), Antenna Unit	24
Pole Mount (1.5" pipe, 38.8 mm), Antenna Unit	28
Pole Mount (2.0" pipe, 53.0 mm), Antenna Unit	30
Interfaces	32
LT-3110S Control Unit	32
LT-3130 Antenna Unit	40
LT-3140S Interface Unit	42
Power Consumption	46
Maximum	46
Average (transmission/reception)	47
DC Isolation Resistance and Chassis Ground	48
Galvanic Isolated Power Supply	50
AC/DC Galvanic Isolated Power Supply	50
DC/DC Galvanic Isolated Power Supply	50
User Interface (UI)	51

Display	52
Menu System	56
Activating the System	58
Acquire a GMDSS SIM card	59
Maritime Safety Service Activation Form (MSSAF)	59
Who's My Service Provider	60
Installation Wizard	61
Radio Survey	72
Change of Hardware and Software	73
Change of Hardware	74
Software update	75
Service Wizard	76
GMDSS Services	77
Distress Alert & Distress Call	78
Distress Alert Relay	84
Maritime Safety Information (MSI)	88
Safety Calling	92
Two-digit Codes	95
Safety Messaging	97
GMDSS Submenu	102
Safety Contacts	103
MSI Schedule	104
MSI Settings	107
Distress Settings	113
Position Settings	117
Printer Settings	121
Location Information	122
SES Information	125
Terminal Test	127
System Services	133
General Calling	133
General Messaging (SMS)	139
External SIP Phones	144
Analogue Phone Adapter	146

Data (Modem Data & SMS)	147
Tracking	150
System Submenus	153
Phone	153
Settings	157
System	161
Bridge Alert Management (BAM)	169
Serial Interface (RS-422)	173
GNSS sentences	173
BAM sentences	174
MSI sentences	175
GMDSS Printers	176
Web server	177
Accessing the built-in web server	178
Dashboard	179
Messages (MSI)	180
Configuration	182
Software update	202
Diagnostic	203
Legal notice	204
Log out	204
Disable login timeout	204
Service & Repair	205
Appendixes	206
App. A - Applicable Standards	206
App. B - Bridge Alert Management (BAM)	207
App. C - Multiple talkers and multiple listeners	216
App. D - GNSS sentences	217
App. E - BAM sentences	219
APP. F - MSI sentences	221
App. G - GNSS Receiver Integrity States (Automatic GNSS)	223
App. H - Specifications	228
App. I - Outline Drawing: LT-3110S Control Unit	230
App. J - Outline Drawing: Bracket Mount, Control Unit	231

App. K - Outline Drawing: Flush Mount, Control Unit	232
App. L - Outline Drawing: LT-3130 Antenna Unit.....	233
App. M - Outline Drawing: LT-3140S Interface Unit	234
App. N - Outline Drawing: LT-3150S Alarm Panel.....	235
App. O - Outline Drawing: LT-3160S Printer Adapter	236
App. P - Outline Drawing: Pole Mount (1.5" pipe, 38.8 mm), Antenna Unit.....	237
App. Q - Outline Drawing: Pole Mount (2.0" pipe, 53.0 mm), Antenna Unit	238
App. R - Outline Drawing: Bracket Mount (1.5" to 2.5" pipe), Antenna Unit.....	239
App. S - Outline Drawing: LT-3120 Handset.....	240
App. T - Outline Drawing: LT-3121 Cradle.....	241
App. U - Conformity	242

Introduction

Congratulations on your purchase of the LT-3100S GMDSS Satellite Communications system!

The LT-3100S GMDSS Satellite Communications system is a maritime satellite communication product from Lars Thrane A/S. The LT-3100S GMDSS system is designed for the professional market (deep sea, fishing, and workboats), but can be used for the leisure market as well. The LT-3100S GMDSS system meets all standards and certification requirements needed for worldwide maritime satellite communication equipment.

The LT-3100S GMDSS system has voice and data capabilities with 100% global coverage provided by the Iridium® Communications Network. The LT-3100S GMDSS system offers the following Iridium® GMDSS Safety Services:

- Distress Alert & Distress Call
- Distress Alert Relay
- Maritime Safety Information (MSI)
- Safety Calling
- Safety Messaging

The LT-3100S GMDSS system - basic consists of a control unit, antenna unit, handset and cradle. The additional GMDSS system units available are:

- LT-3140S Interface Unit
- LT-3150S Alarm Panel
- LT-3160S Printer Adapter

A single coaxial cable connects the control unit with the antenna unit. Using a standard coaxial cable, up to 500 meters of separation between the units can be obtained, giving freedom to mount the antenna unit in the best possible location, with free line of sight to the Iridium satellites.

The LT-3100S GMDSS system can be used as the primary satellite communication product on vessels, covering the basic communication needs in terms of connectivity between the ship and shore and ship to ship.

Application and Limitations

- The LT-3100S GMDSS system shall be installed according to manufacturer's User & Installation Manual.
- The LT-3100S GMDSS system includes an integrated Global Navigation Satellite System (GNSS) receiver for position fixing.
- The LT-3100S GMDSS complies with the requirements for Other Network Function (ONF) as defined in IEC 61162-450 (2018)
- The LT-3100S GMDSS can be used for GMDSS services in Sea Areas A1, or A2 or A3 defined by SOLAS 1974 as amended, where Flag states have recognized Iridium as a mobile satellite service for use in the GMDSS.
- The LT-3100S GMDSS complies with the requirements for reception of MSI through the Iridium SafetyCast service, and can be used for compliance with the carriage requirements for EGC when such services are made available through the Iridium satellite system.
- The LT-3130 Antenna Unit operational low temperature is:
 - -30°C (-22°F) when using 12 VDC input power on the LT-3110S Control Unit
 - -40°C (-40°F) when using 24 VDC input power on the LT-3110S Control Unit

Unpacking (in-the-box)

Unpack the LT-3100S GMDSS Satellite Communications System – Basic (P/N: 90-102071) and check that the following items are present in the box:

- 51-101812 LT-3110S Control Unit
- 51-100988 LT-3120 Handset
- 51-101181 LT-3121 Cradle
- 51-100989 LT-3130 Antenna Unit
- 91-100771 Bracket Mount, Control Unit
- 91-102118 Power Cable, 3m
- 4 x Stainless steel A4 screws (for Bracket Mount, Control Unit)
- 2 x Stainless steel A4 screws (for Cradle)
- 4 x Unit Test Sheets
- 95-102251 LT-3100S GMDSS User & Installation Manual

NOTE: Antenna unit mounts (bracket and pole mount) are not included in the LT-3100S GMDSS Satellite Communications System - Basic (P/N: 90-102071) and must be ordered separately. The antenna unit must only be mounted, using the bracket or pole mount, delivered by Lars Thrane A/S. The antenna unit mounts are listed with part numbers (P/N) in Accessories *on page 4*.

Inspection

Inspect the shipping cartons and/or wooden box immediately upon receipt for evidence of damage during transport. If the shipping material is severely damaged or water stained, request that the carrier's agent is present when opening the cartons and/or wooden box. Save all box packing material for future use.

After unpacking the system and opening the cartons, inspect it thoroughly for hidden damage and loose components or fittings. If the contents are incomplete, if there is mechanical damage or defect, or if the system does not work properly, notify your distributor.

WARNING: To avoid electric shock, do not apply power to the LT-3100S GMDSS system components if there is any sign of shipping damage to any part of a unit or the outer cover. Read the Safety Instructions at the front of this manual before installing or operating the system.

Accessories

GMDSS parts

The following GMDSS parts are not part of the basic system and must be ordered separately:

- 51-101814 LT-3140S Interface Unit
- 51-101815 LT-3150S Alarm Panel (incl. 25m cable)
- 51-101816 LT-3160S Printer Adapter (incl. 25m cable)

SSAS parts

The following SSAS parts are not part of the basic system and must be ordered separately:

- 91-102073 SSAS Alert Button (incl. 50m cable)
- 91-102074 SSAS Test Button (incl. 50m cable)

The Ship Security Alert System (SSAS) functionality is not yet supported. The SSAS functionality will be supported from software v1.05.

Mounts

The following Mount parts are not part of the basic system and must be ordered separately:

- 91-100772 Flush Mount, Control Unit
- 91-102469 Bracket Mount (1.5" to 2.5" pipe), Antenna Unit with Cable Hose
- 91-102470 Cable Hose (standalone)
- 91-100774 Pole Mount (1.5" pipe, 38.8 mm), Antenna Unit
- 91-102520 Pole Mount (2.0" pipe, 53.0 mm), Antenna Unit

In order to avoid corrosion when using the Bracket Mount (1.5" to 2.5" pipe), we have introduced a Cable Hose for the antenna unit, which is recommended to use for all installations using this mount. The Cable Hose is illustrated in Figure 29 on page 27.

Cable and connectors

The following cable and connector parts are not part of the basic system and must be ordered separately:

- 91-100768 Aux Cable, 3m
- 91-101183 Coaxial cable Ø4.9mm, 10m
- 91-101184 Coaxial cable Ø4.9mm, 25m
- 91-101137 Coaxial Cable Ø10.3mm 10m
- 91-101138 Coaxial Cable Ø10.3mm 25m
- 91-101139 Coaxial Cable Ø10.3mm 50m
- 91-101140 N Conn. (male) for Coaxial Cable Ø4.9mm
- 91-101186 N Conn. (male) for Coaxial Cable Ø10.3mm
- 91-101187 Crimping Tool for Coaxial Cable Ø4.9mm
- 91-101188 Crimping Tool for Coaxial Cable Ø10.3mm

Coaxial cables are delivered with one fixed N connector (outdoor mounting), another loose N connector and crimp parts comes with the cable. It is required to use an appropriate crimping tool for attaching the loose N connector.

NOTE: For further details on the cable and connectors, please contact Lars Thrane A/S. A coaxial cable up to a length of 500 meters can be used for connecting the LT-3110S Control Unit and the LT-3130 Antenna Unit. Details about the coaxial cable, specification and cable lengths, are described in *LT-3130 Antenna Unit* on page 40.

System Overview

The LT-3100S GMDSS Satellite Communications System is a standalone communication product, which is using the Iridium® satellite constellation. The LT-3100S GMDSS system is working on the new Iridium® NEXT satellites. An overview of the LT-3100S GMDSS system is illustrated in Figure 1.

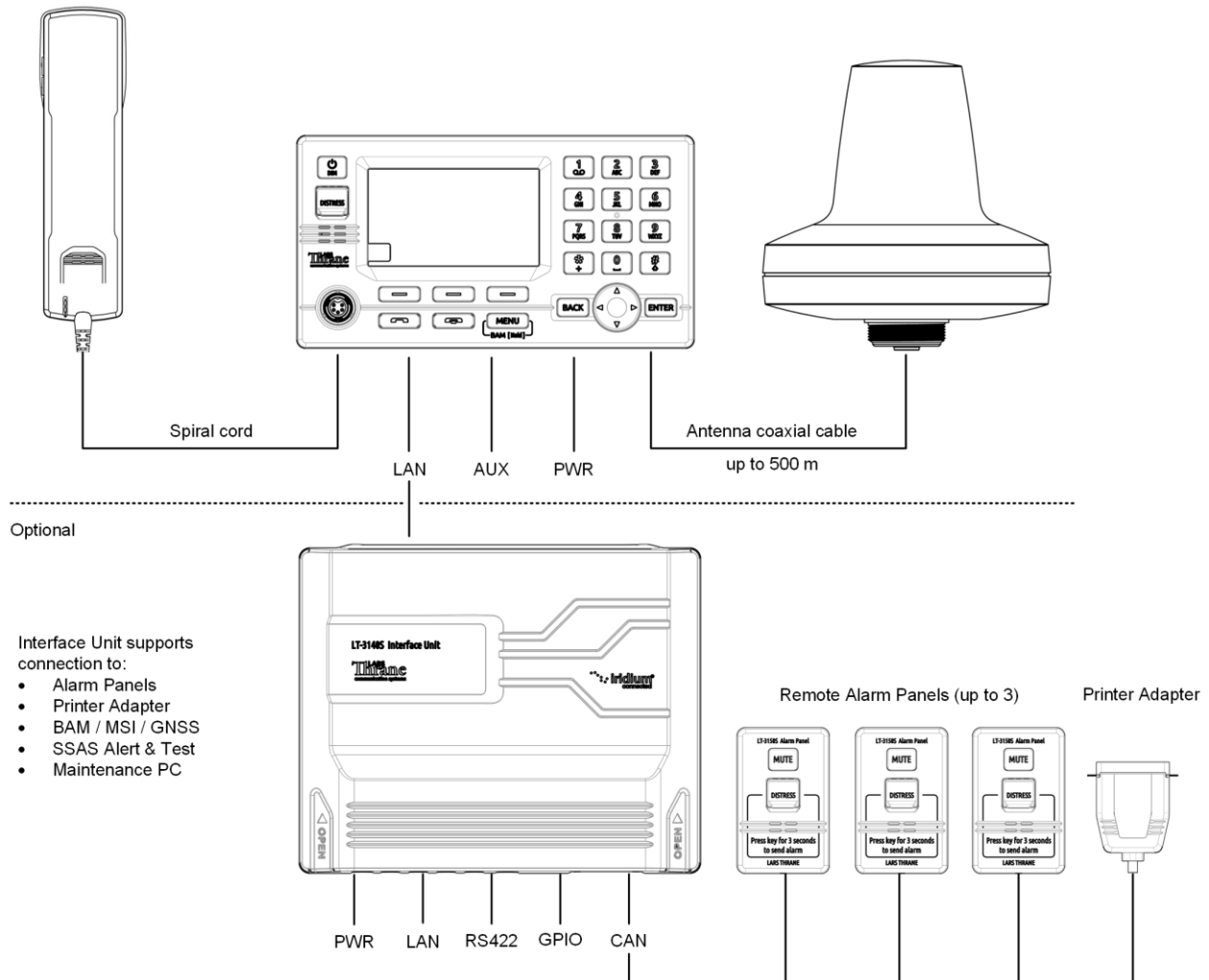

Figure 1: LT-3100S GMDSS system (units and interfaces)

The LT-3100S GMDSS basic system consists of the following units, provided by Lars Thrane A/S:

- LT-3110S Control Unit
- LT-3120 Handset
- LT-3121 Cradle
- LT-3130 Antenna Unit

The following optional units can be bought as add-ons, provided by Lars Thrane A/S:

- LT-3140S Interface Unit
- LT-3150S Alarm Panel
- LT-3160S Printer Adapter

Installation and Mounting

LT-3110S Control Unit

The LT-3110S Control Unit is the master unit in the system, supporting external interfaces and the operational user interface. The LT-3110S Control Unit is designed for indoor mounting. See the specifications in *App. H - Specifications* on page 228.

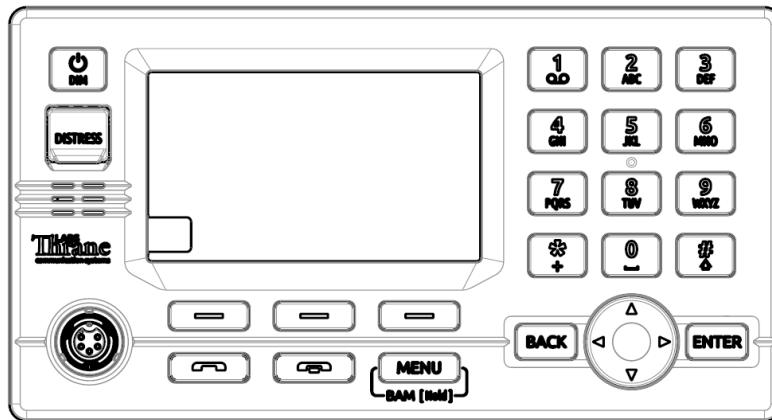

Figure 2: LT-3110S Control Unit (front view)

The LT-3110S Control Unit has the following interfaces:

- 4-pin power connector (male), marked 'PWR'
- Chassis ground connector, marked 'GNDC'
- N connector (female) for coaxial cable to the LT-3130 Antenna Unit, marked 'ANT'
- Ethernet (RJ-45) connector, marked 'LAN'
- 10-pin auxiliary connector (male), marked 'AUX'
- SIM card holder, marked 'SIM'
- 5-pin connector (female) for LT-3120 Handset (front of the control unit)

The interfaces on the back side of the LT-3110S Control Unit are illustrated in Figure 3 on page 8.

The LT-3110S Control Unit interfaces are described in *Interfaces* on page 32. The LT-3110S Control Unit, front and back view, are illustrated in Figure 2 and Figure 3.

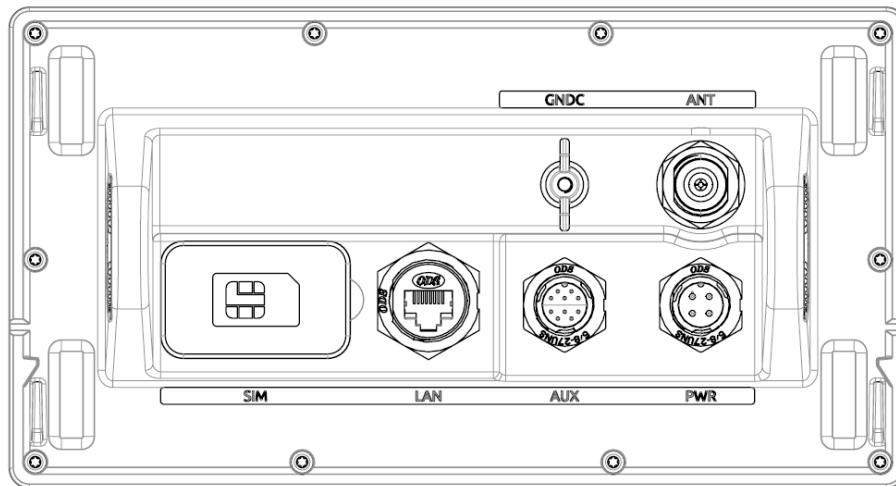

Figure 3: LT-3110S Control Unit (back view)

The LT-3110S Control Unit user interface, display and buttons, are described in *User Interface (UI)* on page 51.

NOTE: The LT-3110S Control Unit must be mounted with either the Bracket Mount, Control Unit (P/N: 91-100771) or Flush Mount, Control Unit (P/N: 91-100772) - illustrated in Figure 4 and Figure 5. The Flush Mount, Control Unit is not included in the LT-3100S GMDSS Satellite Communications System – Basic (P/N: 90-102071) and must be ordered separately.

Mounting and installation considerations:

For optimum system performance, the following guidelines on where to install and mount the LT-3110S Control Unit must be followed. It is recommended to mount the unit in a location, which fulfills these requirements:

- Mount the unit indoor (not exposed to direct water)
- Mount the unit using either the bracket mount or flush mount
- Mount the unit on a rigid structure with a minimum of exposure to vibration and shock
- Mount the unit in an area with an ambient temperature between -15°C to +55°C (+5°F to +131°F)

The Bracket Mount and Flush Mount for the LT-3110S Control Unit are illustrated in Figure 4 and Figure 5.

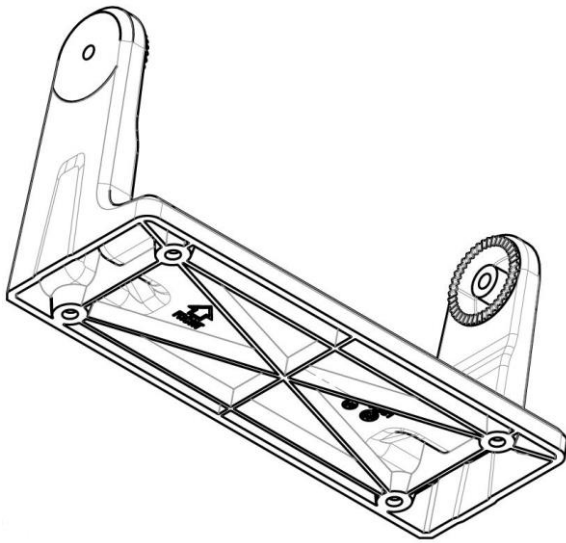

Figure 4: Bracket Mount, Control Unit.

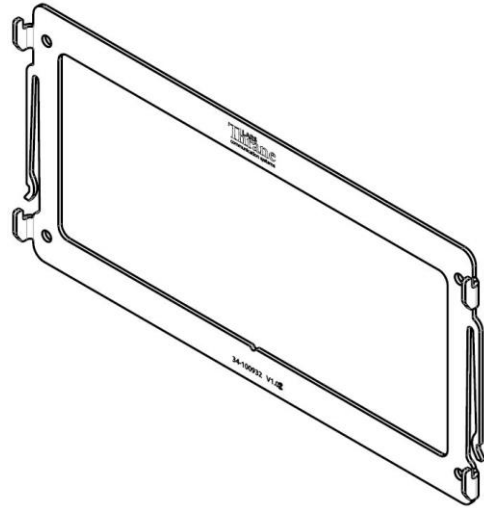

Figure 5: Flush Mount, Control Unit.

LT-3120 Handset

The LT-3120 Handset is the primary voice interface for the LT-3100S GMDSS system. The LT-3120 Handset must be connected on the front of the LT-3110S Control Unit. The connector is illustrated in Figure 2 on page 7.

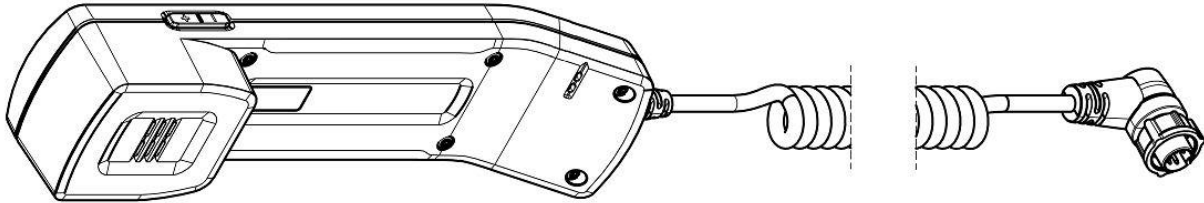

Figure 6: LT-3120 Handset (front view)

The LT-3120 Handset is connected to the LT-3110S Control Unit via a 5-pin proprietary angle connector. The spiral cord, fixed to the LT-3120 Handset is ~ 0.4 m from handset to connector, when coiled. The spiral cord can be stretched to a maximum of 2 m. The LT-3120 Handset is designed for indoor mounting. Check the specifications in *App. H - Specifications* on page 228.

The LT-3120 Handset has the following characteristics:

- High-performance audio speaker and microphone
- Separate ringer (buzzer)
- Speaker volume control (double-button, marked with '+' and '-', for volume up and down)
- Built-in off-hook detection circuit

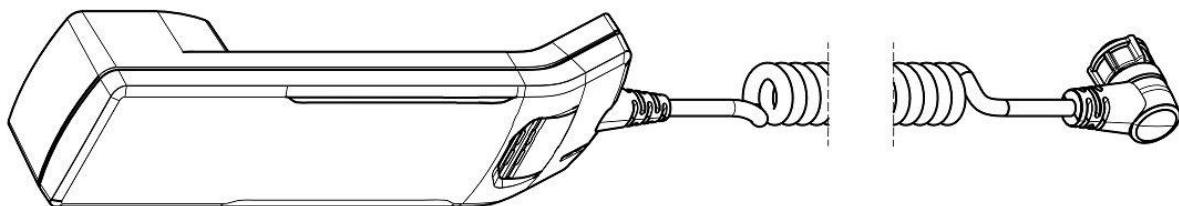

Figure 7: LT-3121 Handset (back view)

NOTE: The LT-3110S Control Unit will inform the user if the LT-3120 handset is not properly connected to the LT-3110S Control Unit. A BAM alert will be activated (Lost handset).

NOTE: The LT-3120 Handset must be operated together with the LT-3121 Cradle, for the off-hook detection circuit to work. The LT-3121 Cradle is described in *LT-3121 Cradle* on page 11.

LT-3121 Cradle

The LT-3121 Cradle is used together with the LT-3120 Handset. The LT-3121 Cradle should be mounted next to the LT-3110S Control Unit, supporting the LT-3120 Handset. The LT-3121 Cradle specifications are available in *App. H - Specifications* on page 228.

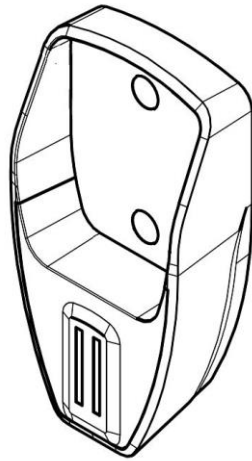

Figure 8: LT-3121 Cradle (front view)

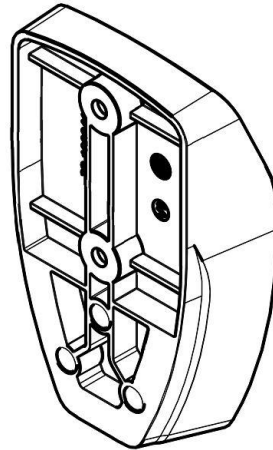

Figure 9: LT-3121 Cradle (back view)

IMPORTANT: The LT-3121 Cradle contains a magnet, to hold on to the LT-3120 Handset. Make sure that other electronic equipment is installed in a distance respecting the compass safe distance of 1.0 m (3.3 ft).

An outline drawing for the LT-3121 Cradle is available in *App. T - Outline Drawing: LT-3121 Cradle* on page 241.

LT-3130 Antenna Unit

The LT-3130 Antenna Unit is designed for outdoor mounting and connected to the LT-3110S Control Unit via a coaxial cable. The LT-3130 Antenna Unit specifications are available in *App. H - Specifications* on page 228. The LT-3130 Antenna Unit has an N connector (female) mounted, centered at the bottom of the antenna.

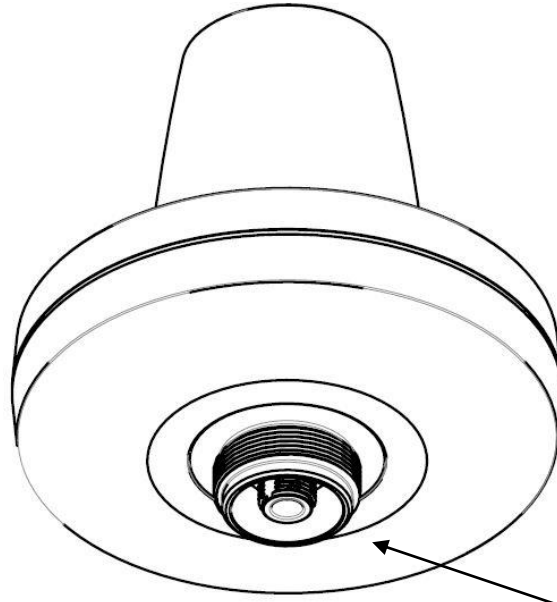

Figure 10: LT-3130 Antenna Unit

The LT-3130 Antenna Unit has an N connector (female) at the bottom side of the unit.

Mounting and installation considerations:

- Mount the unit vertically (with the N connector pointing down)
- Mount the unit with free line of sight to the Iridium® and GNSS satellites. Make sure that the unit can receive signals from the Iridium® and GNSS satellites (satellite reception information is available in the LT-3110S Control Unit user interface display, see Figure 52 on page 52)
- Mount the unit on a rigid structure with a minimum of exposure to vibration and shock
- Mount the unit using either the Bracket Mount or Pole Mount provided by Lars Thrane A/S
- Mount the unit outdoor with an ambient temperature between -40°C to +55°C (-40°F to +131°F)
- Mount the unit with a minimum angle of 20 degrees towards a radar antenna (above or below) and keep a minimum distance of 2.5 m (8 ft)
- Mount the unit at least 1 m. (3 ft.) away from radio transmitting antennas (VHF, UHF, MF-HF)
- Mount the unit away from Inmarsat and transmitting VSAT antennas

NOTE: It is only the LT-3130 Antenna Unit marked with HVIN 2.00 (Unit Label) or newer that can be used for the LT-3100S GMDSS Satellite Communications System. The LT-3100S GMDSS software will check the antenna unit during power up and the system will not be operational, if connecting a legacy LT-3130 Antenna Unit.

In order to avoid breaking the LT-3130 Antenna Unit N connector (female), it is important not to use tooling when connecting and fastening the coaxial cable N connector (male) to the antenna unit. The coaxial cable N connector thread nut must be fastened by hand only.



Figure 11: Connecting the coaxial cable N connector to the LT-3130 Antenna Unit

IMPORTANT: Maximum allowed torque is 2 Nm when connecting the coaxial cable N connector (male) to the N connector (female) of the LT-3130 Antenna Unit. No tooling must be used for fastening the coaxial cable thread nut as illustrated on Figure 11 above.

The LT-3130 Antenna Unit has a hazard warning label attached to the radome as illustrated in Figure 12.

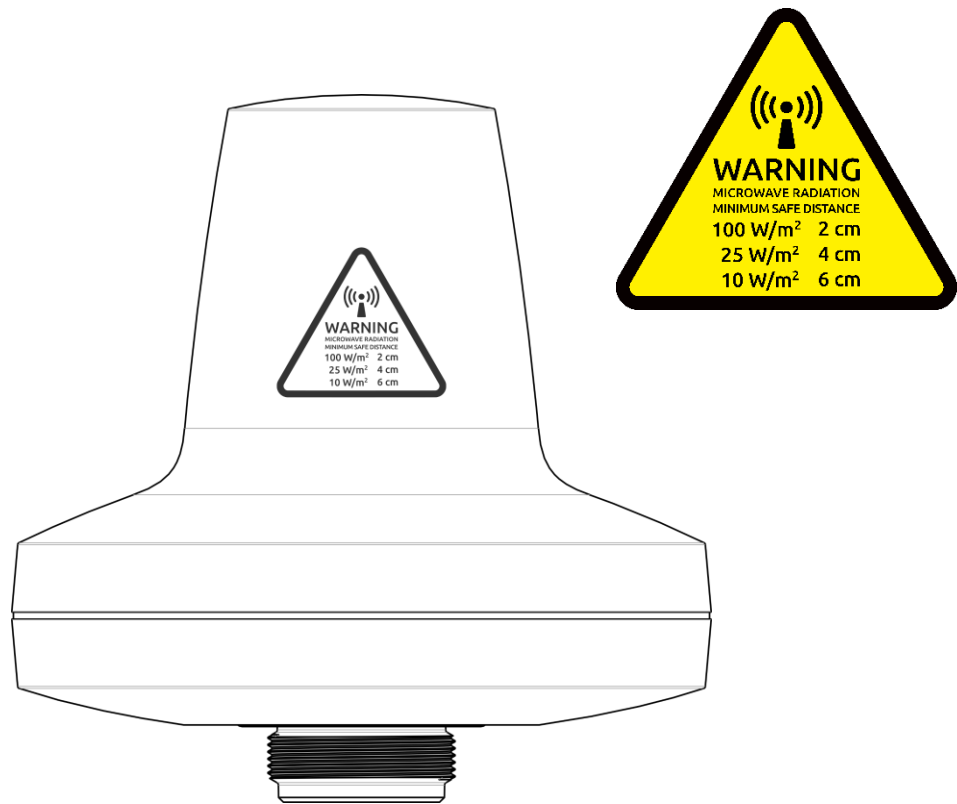

Figure 12: LT-3130 Antenna Unit (incl. warning label)

WARNING: The safety distance from the LT-3130 Antenna Unit, is 0.1 m (0.3 ft), in order to comply with the regional regulations.

IMPORTANT: Due to the adjacency of the Iridium and Inmarsat frequency bands, the LT-3130 Antenna Unit may not co-operate in the proximity of an active Inmarsat antenna unit, see *Coexisting with Inmarsat L-band* on page 19.

The LT-3130 Antenna Unit must be installed outside the main beam of the radar. Typically, this is in the order of 10 degrees. To avoid near field antenna coupling, a minimum distance of 2.5 m (6 ft) between the radar antenna and the LT-3130 Antenna Unit must be obeyed. Figure 13 is illustrating how the LT-3130 Antenna Unit should be mounted to avoid interference from radars.

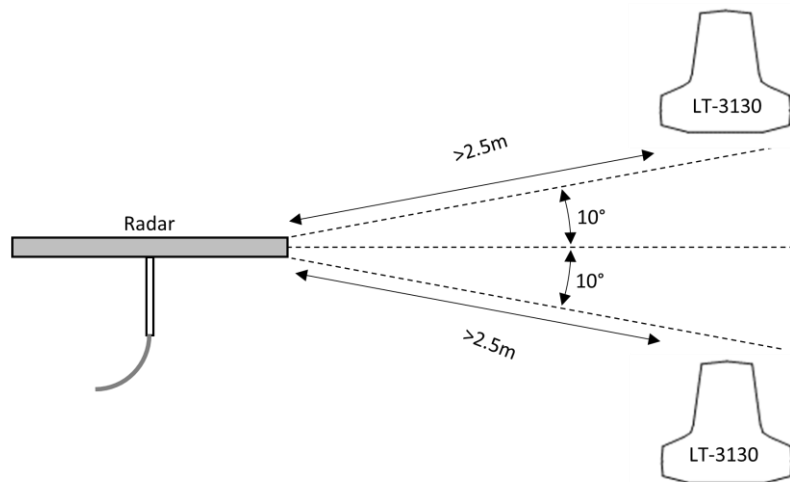

Figure 13: LT-3130 Antenna Unit (avoid the radar beam)

IMPORTANT: Failing to obey the specified installation conditions will void the warranty. However, depending on the specific radar frequency and power level, the separation distance between the radar and the LT-3130 Antenna Unit may be reduced, with no impact on the antenna performance. The performance of the LT-3130 Antenna Unit should be validated after the LT-3100S GMDSS system is installed.

The LT-3130 Antenna Unit must be mounted minimum 1 m from MF-HF, VHF, and UHF antennas.

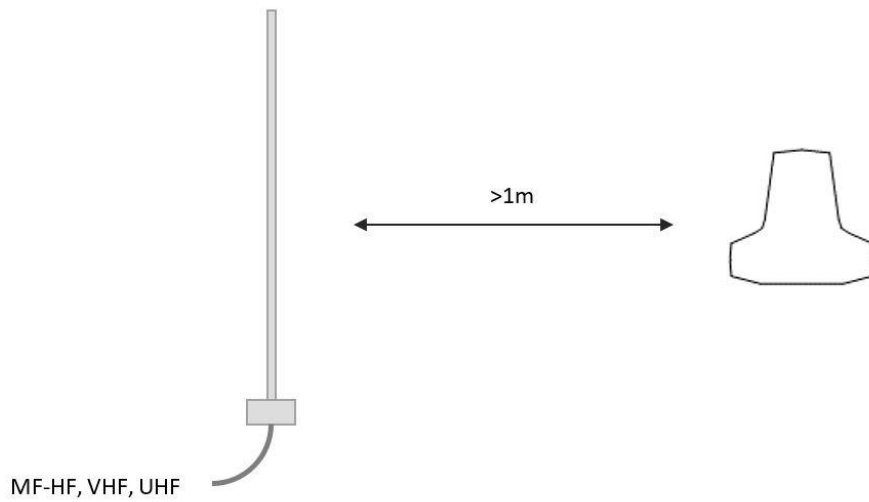

Figure 14: LT-3130 Antenna Unit (separation to MF-HF, VHF, and UHF antennas)

NOTE: The LT-3130 Antenna Unit must be installed with a 360° clear view of the sky. However, minor obstructions such as a mast will not degrade the antenna performance severely if a separation distance is kept larger than 15 times the diameter of the obstruction.

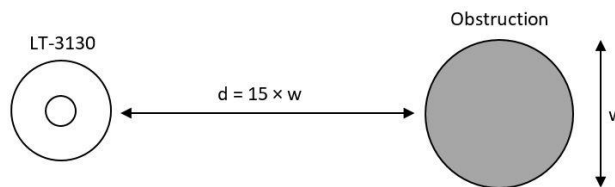

Figure 15: LT-3130 Antenna Unit (separation distance to minor obstructions)

The LT-3130 Antenna Unit must be mounted using one of the mounts listed in *Mounts* on page 4

The LT-3130 Antenna Unit must be mounted with free line of sight to the Iridium satellites for best possible performance. The best location will typically be at the top of the lantern mast, where there are no obstructions blocking the Iridium satellite link. The LT-3130 Antenna Unit is designed to maintain a communication link to the Iridium satellites in all weather conditions, see Table 2.

Extreme Ship Motion Values & Clear View Angles Below the Horizontal Plan			
Motion Direction	Maximum Amplitude	Iridium Satellite Acq.	Clear View Angle Below the Horizontal Plan
Roll	±30°	+8°	-22°
Pitch	±10°	+8°	-2°

Table 2: LT-3130 AU Roll and Pitch Clear View Angles (below the horizontal plan)

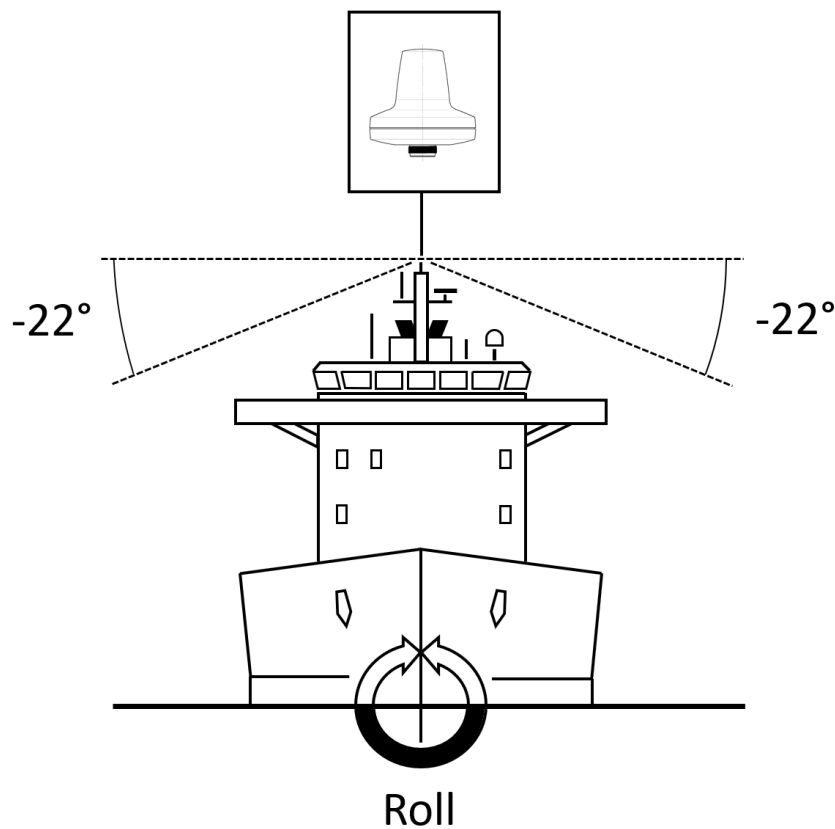

Figure 16: LT-3130 AU Installation (roll: clear view angle below the horizontal plan)

NOTE: The LT-3130 Antenna Unit must be mounted with a -22° clear view angle below the horizontal plan (port and starboard directions), where no obstructions must block the Iridium satellite signal, to maintain full functionality under extreme roll conditions. Also, the upper hemisphere must also be without any blockages to the Iridium satellites.

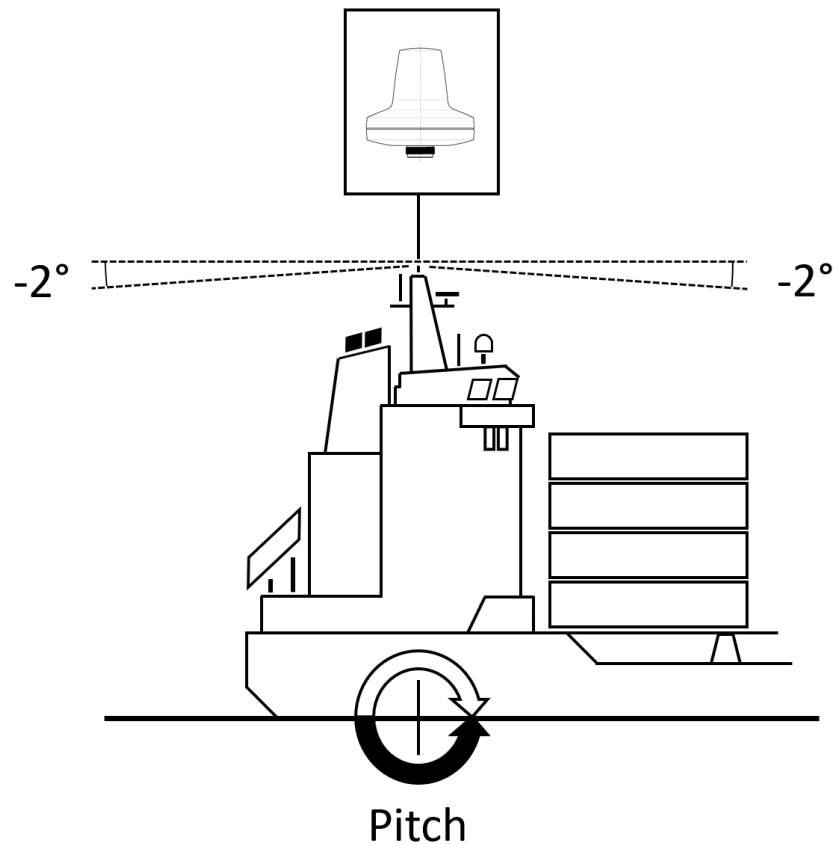

Figure 17: LT-3130 AU Installation (pitch: clear view angle below the horizontal plan)

NOTE: The LT-3130 Antenna Unit must be mounted with a -2° clear view angle below the horizontal plan (fore and after directions), where no obstructions must block the Iridium satellite signal, to maintain full functionality under extreme pitch conditions. Also, the upper hemisphere must be without any blockages to the Iridium satellites.

IMPORTANT: For best possible performance of the LT-3100S GMDSS system, the LT-3130 Antenna Unit must have free line of sight to the Iridium satellites as illustrated in Figure 16 and in Figure 17 (clear view angle below the horizontal plan). In order to have the best possible performance, also in an emergency situation, obstructions should be below the marked lines of these two illustrative figures.

Coexisting with Inmarsat L-band

It is possible to install the LT-3100S GMDSS system onboard a vessel that already has Inmarsat C equipment installed.

It is important to note that the LT-3130 Antenna Unit must be mounted below the Inmarsat C antenna with a minimum distance of 1 m and below an angle of minimum 15° when coexistence is required.

Practical use of the LT-3100S GMDSS system during Alpha and Beta Sea trials, installed onboard vessels with Inmarsat equipment, has not revealed any degradation in system performance.

The LT-3100S GMDSS system will continuously try to deliver the Iridium GMDSS Safety Services e.g., Distress Alert and Safety Messaging in a situation where the LT-3100S GMDSS system may experience degradation or loss of satellite signal. Whenever the satellite signal is back again, the terminal will resume and finalize the requested Safety Service to provide the highest level of safety for the crew.

Survival distances:

Mount the LT-3130 Antenna Unit at a minimum distance of 1 m from an Inmarsat C antenna.

Mount the LT-3130 Antenna Unit at a minimum distance of 3 m from an Inmarsat Fleet Broadband antenna.

LT-3140S Interface Unit

The LT-3140S Interface Unit is designed for indoor mounting and is connected directly to the LT-3110S Control Unit via an Ethernet cable. The LT-3140S Interface Unit specifications are available in *App. H - Specifications* on page 228.

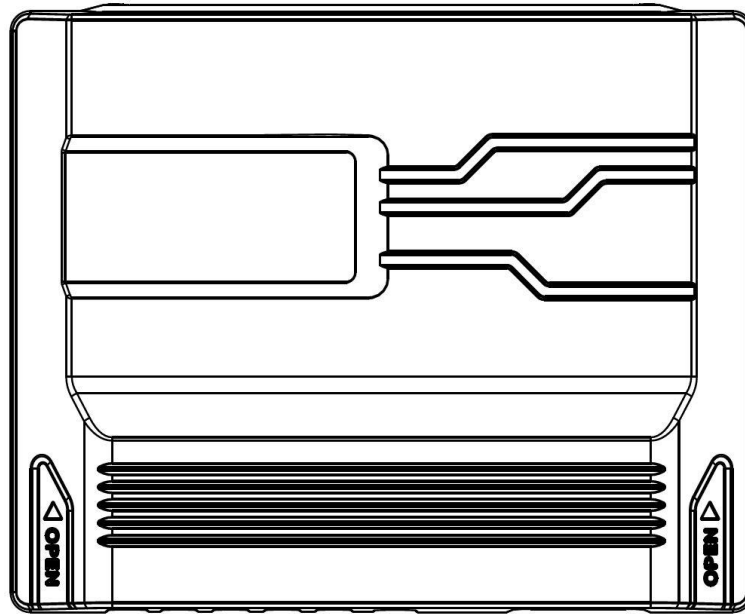

Figure 18: LT-3140S Interface Unit (with front cover).

The LT-3140S Interface Unit without front cover is illustrated in Figure 43 on page 42.

The LT-3140S Interface Unit front cover can be removed by pushing on both sides of the front cover, marked with the text 'Open' and press the front cover upwards (hold tight to the backplate, if the unit is not mounted).

Once, the LT-3140S Interface Unit front cover has been removed, the LT-3140S Interface Unit can be flush mounted on a surface. Use all four screw holes (every corner) of the backplate, to fasten the unit sufficiently.

The LT-3140S Interface Unit interfaces are described in *LT-3140S Interface Unit* on page 42.

LT-3150S Alarm Panel

The LT-3150S Alarm Panel is designed for indoor mounting and connected to the LT-3140S Interface Unit via a proprietary 4-wire CAN cable. The LT-3150S Alarm Panel specifications are available in *App. H - Specifications* on page 228.

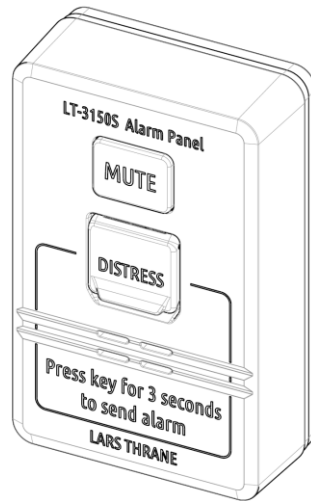

Figure 19: LT-3150S Alarm Panel

The LT-3150S Alarm Panel consist of the following human interface functions: DISTRESS button, DIM button, and speaker. The LT-3150S Alarm Panel is delivered with a 25m cable attached to the unit.

The wire designation of the LT-3150S Alarm Panel is described in Table 3. The LT-3150S Alarm Panel can only be connected to the LT-3140S Interface Unit.

LT-3150S AP Interconnect Details	
Wire Color	Wire Designation
White	VCC
Yellow	CAN+
Green	CAN-
Brown	GND

Table 3: LT-3150S Alarm Panel (interconnect details)

IMPORTANT: See *Distress Alert & Distress Call* on page 78 for operation of the DISTRESS button and activation of Distress Alert and Distress Call.

The LT-3150S Alarm Panel must be flush mounted. A flush mount is delivered together with the LT-3150S Alarm Panel. The LT-3150S Alarm Panel with the flush mount is illustrated in Figure 20.

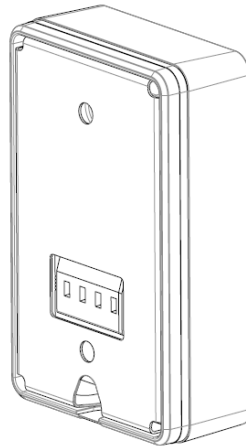

Figure 20: LT-3150S Alarm Panel (back view)

The LT-3150S Alarm Panel can be released from the flush mount by using a release tool as illustrated in Figure 21 and Figure 22.

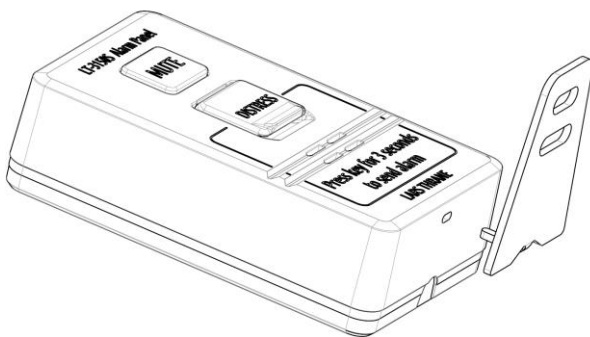

Figure 21: LT-3150S Alarm Panel (release tool)

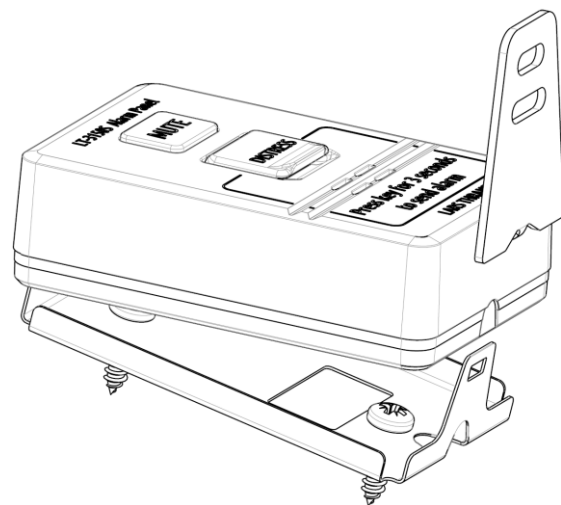

Figure 22: LT-3150S Alarm Panel (release tool)

LT-3160S Printer Adapter

The LT-3160S Printer Adapter is designed for indoor mounting and connected to the LT-3140S Interface Unit via a proprietary 4-wire CAN cable. The LT-3160S Printer Adapter specifications are available in *App. H - Specifications* on page 228.

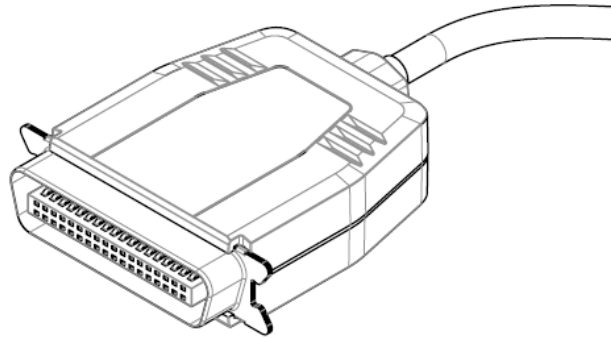

Figure 23: LT-3160S Printer Adapter

The LT-3160S Printer Adapter is interfacing to a GMDSS printer, using the Centronics interface, 36 pins (IEEE Std 1284-2000, 1284-B receptacle connector). The LT-3160S Printer Adapter is delivered with a 25m cable attached to the unit.

The wire designation of the LT-3160S Printer Adapter is described in Table 4. The LT-3160S Printer Adapter can only be connected to the LT-3140S Interface Unit.

LT-3160S PA Interconnect Details	
Wire Color	Wire Designation
White	VCC
Yellow	CAN+
Green	CAN-
Brown	GND

Table 4: LT-3160S Printer Adapter (interconnect details)

The list of GMDSS printers supported and tested are available in *GMDSS Printers* on page 176.

Bracket Mount (1.5" to 2.5" pipe), Antenna Unit

The new Cable Hose designed for the Bracket Mount (1.5" to 2.5" pipe), Antenna Unit must be used going forward as part of the installation. Part Number (P/N): 91-100773 will be replaced with P/N: 91-102469 (including the Cable Hose). The Cable Hose is illustrated with the bracket Mount (1.5" to 2.5" pipe) , Antenna Unit in Figure 24. The new Cable Hose must be used to protect the LT-3130 Antenna Unit (P/N: 51-100989) and coaxial cable N connector from corrosion over time. The Cable Hose can be ordered separately from Lars Thrane A/S on the following P/N: 91-102470 Cable Hose (standalone).

The Cable Hose, incl. installation steps, is more detailed illustrated in document: 43-100773 Bracket Mount Assembly (Illustrations).

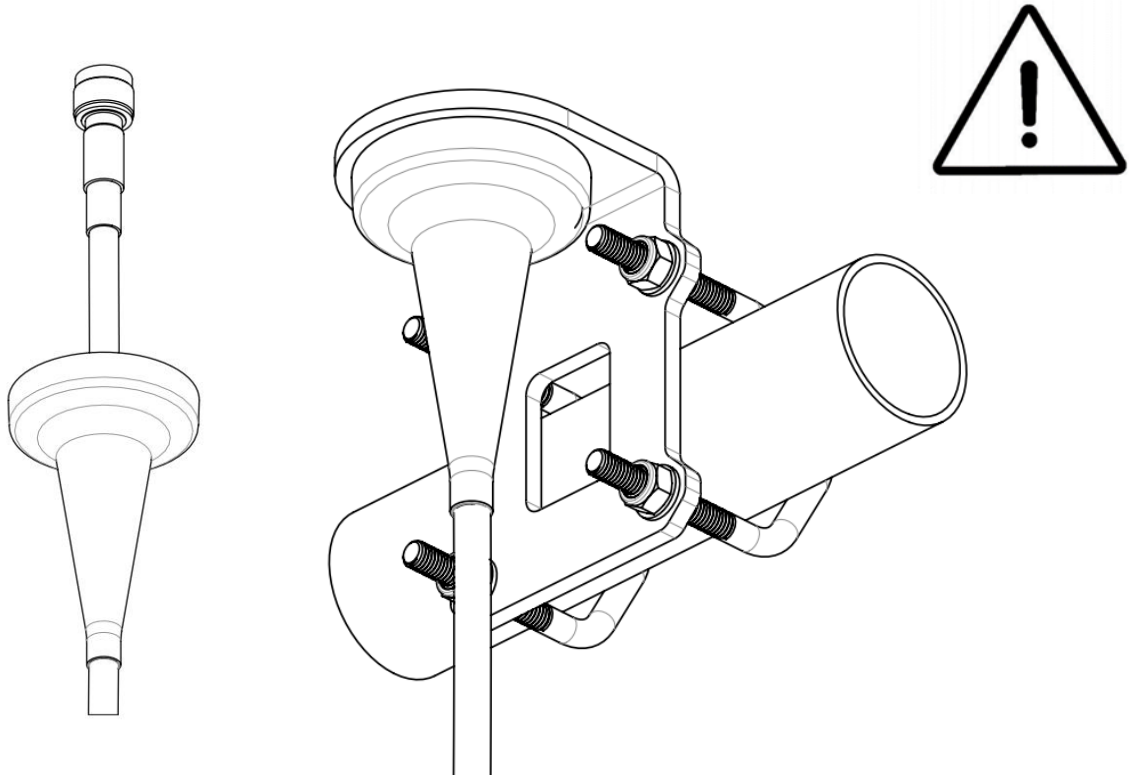

Figure 24: Bracket Mount (1.5" to 2.5" pipe), Antenna Unit with Cable Hose

IMPORTANT: The Cable Hose illustrated above with the Bracket Mount (1.5" to 2.5" pipe), Antenna Unit must be used as part of the installation.

For additional questions about installation of the Bracket Mount (1.5" to 2.5"), Antenna Unit and Cable Hose, please contact your local distributor.

The Bracket Mount (1.5" to 2.5" pipe), Antenna Unit installation options are illustrated in Figure 25 to Figure 30.

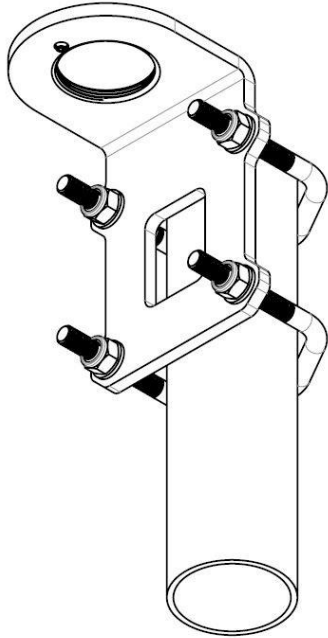

Figure 25: Bracket Mount (1.5" to 2.5" pipe), Antenna Unit (vertical pipe mount)

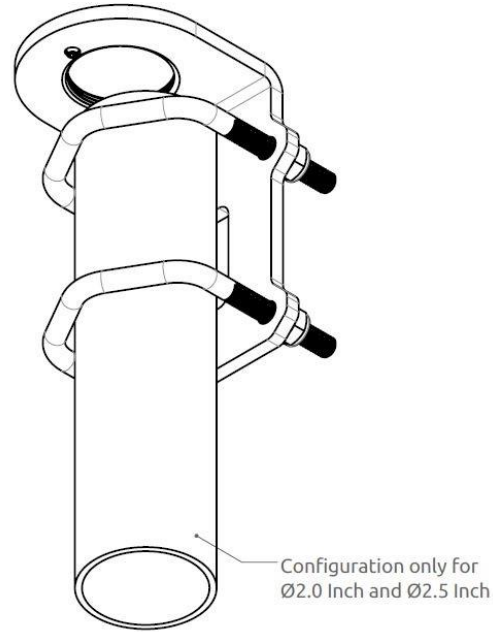

Figure 26: Bracket Mount (1.5" to 2.5" pipe), Antenna Unit (vertical pipe mount)

Bracket mount installation procedure:

1. Fasten the bracket mount to a pipe (max. 2.5" pipe) by using the two V-bolts and the M8 prevailing nuts, as illustrated in Figure 28 on page 26 (max torque = 5.5 Nm)
2. Screw on the LT-3130 Antenna Unit and secure the antenna lock pinot (max torque = 1.2 Nm)
3. Fasten the coaxial cable to the LT-3130 Antenna Unit (N connector)
4. Apply self-volcanic tape on the N connector and cable to protect against saltwater and corrosion or use the recommend Cable Hose

NOTE: Always fasten the Bracket Mount, Antenna Unit (1.5" to 2.5" pipe) to the pipe, before installing the LT-3130 Antenna Unit (the antenna unit and bracket mount are fastened together by the thread lock). Remember to secure the pinot screw after the antenna unit has been fastened. The torques are specified in Figure 28 on page 26.

NOTE: The Bracket Mount (1.5" to 2.5" pipe), Antenna Unit interfaces to a pipe of maximum 2.5" (63.5 mm), measured outer diameter.

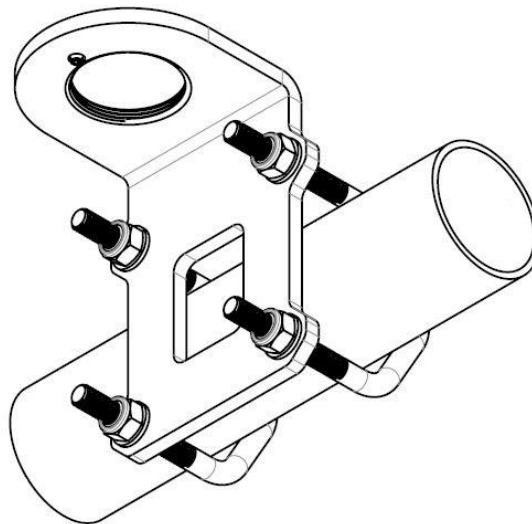

Figure 27: Bracket Mount (1.5" to 2.5" pipe), Antenna Unit (horizontal pipe mount)

The Bracket Mount (1.5" to 2.5" pipe), Antenna Unit can support tubes in the interval 1.5" to 2.5". The torques are specified in Figure 28. The bracket mount, V-bolts, and nuts are all made of A4 stainless steel.

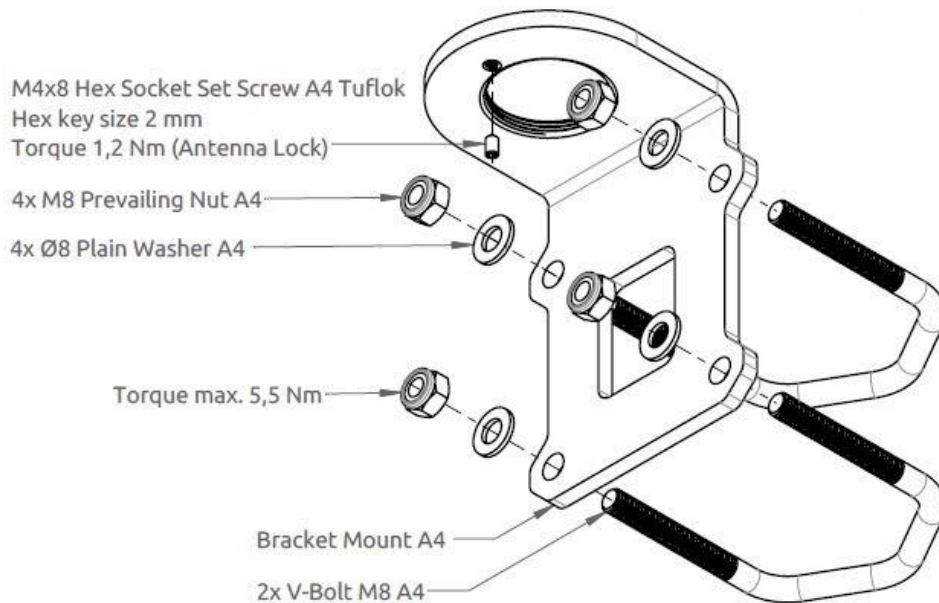

Figure 28: Bracket Mount (1.5" to 2.5" pipe), Antenna Unit (horizontal pipe mount)

To avoid corrosion issues when using the Bracket Mount (1.5" to 2.5" pipe), Antenna Unit - it is recommended to use the cable hose as illustrated in Figure 29 and in Figure 30. The cable hose consists of a UV resistant silicone tube and an aluminum anodized thread block, which can be fastened to the LT-3130 Antenna Unit providing protection to the coaxial cable N connector and surroundings.

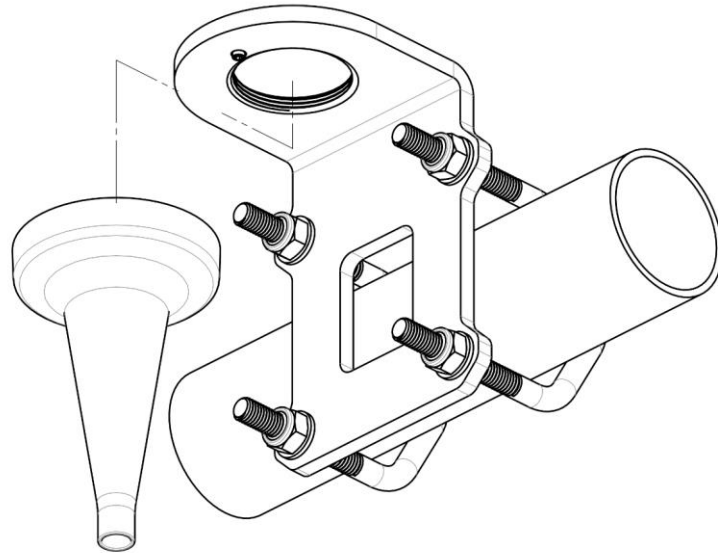

Figure 29: Bracket Mount (1.5" to 2.5" pipe), Antenna Unit with Hose

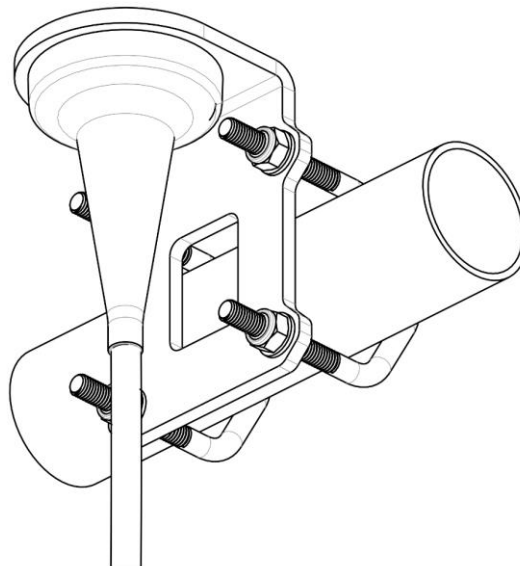

Figure 30: Bracket Mount (1.5" to 2.5" pipe), Antenna Unit with Hose

NOTE: The cable hose will be included in the new ordering number for the Bracket Mount (1.5" to 2.5" pipe), Antenna Unit. The cable hose can also be ordered separately. See *Mounts* on page 4 for more details on the ordering numbers regarding the cable hose.

Pole Mount (1.5" pipe, 38.8 mm), Antenna Unit

The Pole Mount (1.5" pipe, 38.8 mm), Antenna Unit is illustrated in Figure 31 to Figure 33.

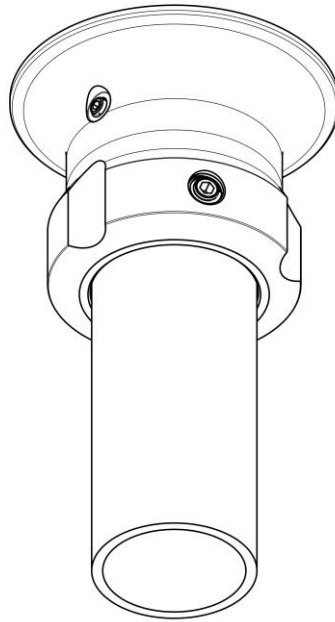

Figure 31: Pole Mount (1.5" pipe, 38.8 mm), Antenna Unit

Pole mount installation procedure:

1. Feed the coaxial cable through the pole mount
2. Fasten the coaxial cable to the LT-3130 Antenna Unit (N connector)
3. Apply self-vulcanic tape on the N connector and cable to protect against saltwater and corrosion
4. Screw the pole mount (clockwise) on the LT-3130 Antenna Unit, and fasten the antenna lock pinot screw, as illustrated in Figure 33 (max torque = 1.2 Nm)
5. The LT-3130 Antenna Unit and pole mount can now be mounted on the 1.5" pipe. Fasten the three pole lock pinot screws, as illustrated in Figure 32 (max torque = 4.5 Nm)

NOTE: Remember to fasten the antenna lock pinot screw (1.2 Nm) after the pole mount and antenna unit have been screwed together.

NOTE: The Pole Mount (1.5" pipe, Ø38.8 mm), Antenna Unit interfaces to a tube of maximum 1.5" (38.8 mm), measured outer diameter.

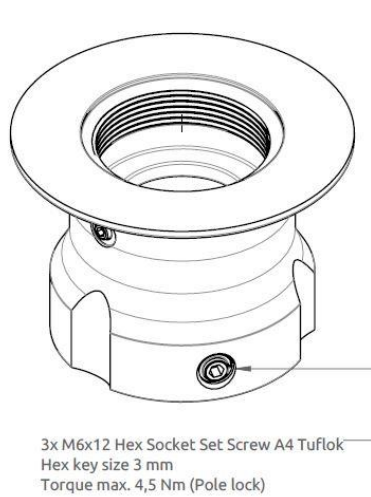

Figure 32: Pole Mount (1.5" pipe, Ø38.8 mm), Antenna Unit

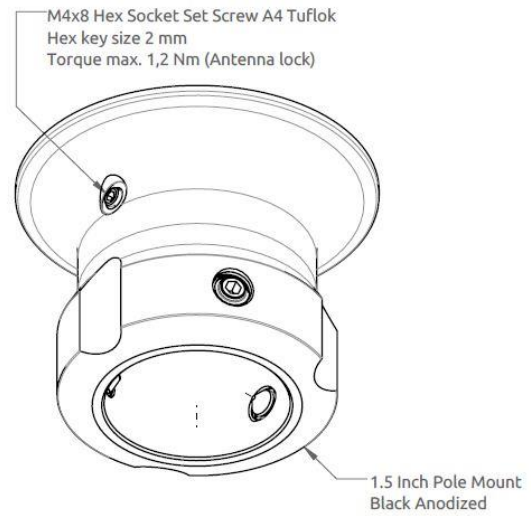

Figure 33: Pole Mount (1.5" pipe, Ø38.8 mm), Antenna Unit

NOTE: The Pole Mount (1.5" pipe, Ø38.8 mm), Antenna Unit only support a 1.5" pipe. The pinot screws (antenna and pole lock) torques are specified in Figure 32 and Figure 33. The pole mount is made of milled aluminum (anodized). The pinot screws are made of A4 stainless steel.

Pole Mount (2.0" pipe, 53.0 mm), Antenna Unit

The Pole Mount (2.0" pipe, Ø53.0 mm), Antenna Unit is illustrated in Figure 34 to Figure 36.

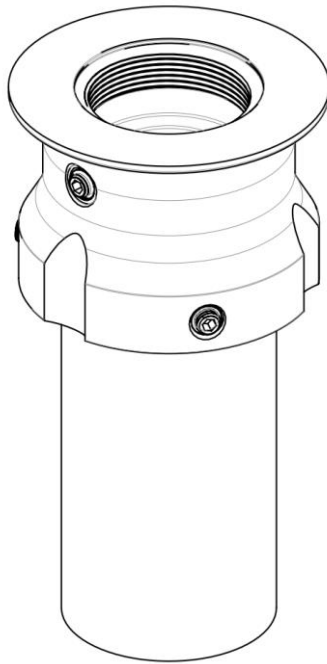

Figure 34: Pole Mount (2.0" pipe, Ø53.0 mm), Antenna Unit.

Pole mount installation procedure:

1. Feed the coaxial cable through the pole mount
2. Fasten the coaxial cable to the LT-3130 Antenna Unit (N connector)
3. Apply self-vulcanic tape on the N connector and cable to protect against saltwater and corrosion
4. Screw the pole mount (clockwise) on the LT-3130 Antenna Unit, and fasten the antenna lock pinot screw, as illustrated in Figure 36 (max torque = 1.2 Nm)
5. The LT-3130 Antenna Unit and pole mount can now be mounted on the 2.0" pipe. Fasten the three pole lock pinot screws, as illustrated in Figure 35 (max torque = 4.5 Nm)

NOTE: Remember to fasten the antenna lock pinot screw (1.2 Nm) after the pole mount and antenna unit have been screwed together.

NOTE: The Pole Mount (2.0" pipe, Ø53.0 mm), Antenna Unit interfaces to a pipe of maximum 2.0" (53.0 mm), measured outer diameter.

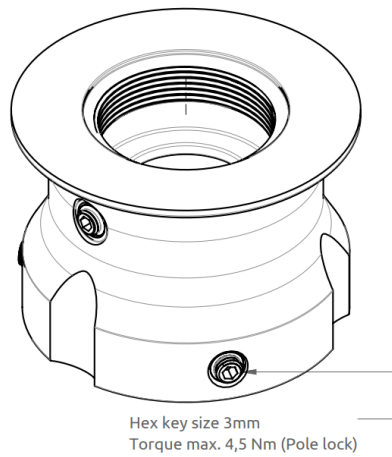

Figure 35: Pole Mount (2.0" pipe, Ø53.0 mm), Antenna Unit.

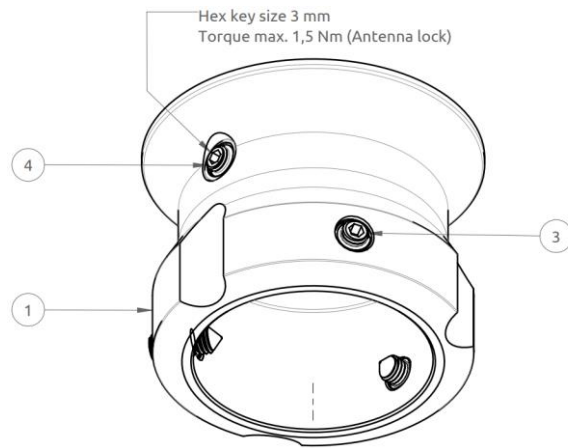

Figure 36: Pole Mount (2.0" pipe, Ø53.0 mm), Antenna Unit.

NOTE:

The Pole Mount (2.0" pipe, Ø53.0mm), Antenna Unit only supports a 2.0" pipe. The pinot screws (antenna and pole lock) torques are specified in Figure 35 and Figure 36. The pole mount is made of milled aluminum (anodized). The pinot screws are made of A4 stainless steel.

Interfaces

LT-3110S Control Unit

This section will describe all the external interfaces from the LT-3110S Control Unit.

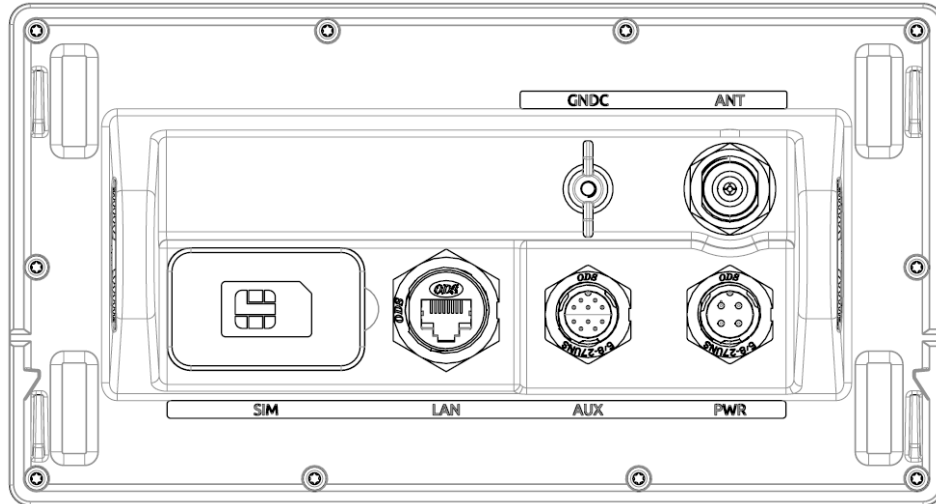

Figure 37: LT-3110S Control Unit (back view)

DC input (PWR)

The LT-3100S GMDSS system is designed to be used on 12 VDC and 24 VDC power buses (nominal). External DC power to the LT-3100S GMDSS system is provided by connecting the proprietary 91-102118 Power Cable, 3m - delivered by Lars Thrane A/S. The power connector is mounted on the back side of the LT-3110S Control Unit and marked 'PWR', see Figure 37.

The power source for the LT-3100S GMDSS System must comply with the GMDSS regulations and the associated standards, minimum is compliance to IEC 60945 (2002). The power source to LT-3110S Control Unit and the LT-3140S Interface Unit must be connected to the main and emergency source of power as required by SOLAS reg II-1/42 or /43, and a battery backup system. When extending the power supply cables the positive (+) and the negative (-) must be installed closely together in order to keep the cable inductance low.

NOTE: Make sure to use a galvanic isolated power supply as illustrated in *Galvanic Isolated Power Supply* on page 50.

NOTE: The input voltage range is: 12-24 VDC (2.2-1.7A). The LT-3110S Control Unit DC input connector and circuit is protected and certified for reverse polarity protection.

NOTE: The LT-3130 Antenna Unit operational low temperature is:
 -30°C (-22°F) when using 12 VDC input power on the LT-3110S Control Unit
 -40°C (-40°F) when using 24 VDC input power on the LT-3110S Control Unit

NOTE: The DC input power source must be connected to a battery backup system (requirement for all SOLAS vessels). The power source and battery backup system are not provided by Lars Thrane A/S.

NOTE: It may be noted that for vessels without an emergency source of power it may be possible to install the LT-3100S GMDSS system, if the capacity of the reserve source (battery backup) is at least 6 hours.

NOTE: A new power connector (4-pole) has been introduced with the LT-3110S Control Unit. This new power connector requires the new 91-102118 power cable, 3m from Lars Thrane A/S. Use only the 91-102118 power cable, 3m delivered by Lars Thrane A/S.

Chassis ground (GNDC)

The chassis ground connector is placed on the back side of the LT-3110S Control Unit and marked with 'GNDC', see Figure 37 on page 32.

GMDSS SIM card (SIM)

The LT-3100S GMDSS system requires a GMDSS SIM card to be operated with the Iridium® satellite services. The Iridium® GMDSS SIM card must be bought from one of the official Iridium® GMDSS Service Providers. A list of Iridium® GMDSS Service Providers can be found at the Iridium® website: <https://www.iridium.com> (select 'Services', and hereafter 'Iridium GMDSS').

The GMDSS SIM card must be inserted in the LT-3110S Control Unit behind the rubber dust cover. Make sure that the LT-3110S Control Unit is powered off before opening the rubber dust cover. When the GMDSS SIM card is properly inserted in the slot, and the rubber dust cover is secured, the LT-3110S Control Unit can be powered up. The rubber dust cover is illustrated in Figure 37 on page 32 and marked with 'SIM'.

The following procedure must be followed when inserting, replacing, or removing the GMDSS SIM card:

1. Turn off the power to the LT-3110S Control Unit
2. Remove the rubber dust cover on the back side of the LT-3110S Control Unit
3. Slide the SIM card holder as illustrated with the arrows on the PCB print, to unlock
4. Open the SIM card holder and insert or remove the SIM card
5. Close the SIM card holder
6. Slide the SIM card holder as illustrated with the arrows on the PCB (opposite direction), to lock
7. Re-insert the rubber dust cover
8. Turn on power to the LT-3110S Control Unit

NOTE: The LT-3110S Control Unit must be powered off when inserting, changing, or removing the GMDSS SIM card. The GMDSS SIM card is hidden behind the rubber dust cover on the back side of the LT-3110S Control Unit.

Figure 38 is illustrating an Iridium GMDSS SIM card. The format is Mini-SIM (2FF) 25 x 15 mm. The GMDSS SIM card must be removed from the full-sized card carrier by breaking the Mini-SIM out. The full-sized card carrier contains the MSISDN number, while the SIM card itself contains the ICCID.

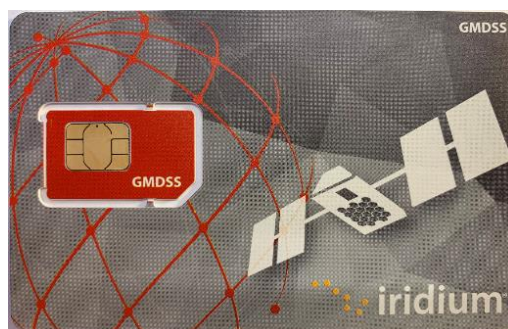

Figure 38: Iridium GMDSS SIM card

The GMDSS SIM card will be delivered from the Iridium GMDSS Service Providers (SP) together with the essential information:

- MSISDN number (the Iridium Mobile Subscriber ISDN number)
- ICCID

IMPORTANT: During activation of the GMDSS SIM Card, the Iridium GMDSS Service Provider will request vessel details (Vessel name, IMO number, MMSI number, etc.). This essential data must be delivered correctly to the Iridium GMDSS Service Provider and will be validated upon completing the Installation Wizard. If any of the data is not correct, then the Iridium GMDSS Service Provider must be contacted and data must be corrected, before finalizing the GMDSS installation and activation.

The GMDSS SIM card will be delivered with the SIM lock feature disabled. Thus, the LT-3100S GMDSS system will be operational as soon as the GMDSS SIM card is inserted, and the Installation Wizard has been completed. The activation of the LT-3100S GMDSS system, hereunder the Installation Wizard, is described in further details in *Activating the System* on page 58.

NOTE: The GMDSS SIM card will be delivered with the SIM lock feature disabled. It is not possible to activate the SIM lock, since it always must be possible to use the system as the primary safety communication system.

Ethernet RJ45 (LAN)

The LT-3110S Control Unit has an Ethernet LAN (RJ-45) interface, supporting service & maintenance or connection to the LT-3140S Interface Unit. The Ethernet interface can be used to access the built-in web server, which is further described in *Web server* on page 177.

The LT-3110S Control Unit will automatically request and obtain an IP address when connected to a Local Area Network (LAN) with a DHCP server (e.g. a router). If connecting the LT-3110S Control Unit directly to a PC, then the two will automatically negotiate an IPv4 Link-Local address. The current IP address can be found in the user interface display (Menu -> System -> Network: IP Address).

NOTE: LT-3100 GMDSS system is permitted to be connected to an IEC 61162 Ethernet network.

Auxiliary (AUX)

The auxiliary connector is a 10-pin connector (male) mounted on the backside of the LT-3110S Control Unit as illustrated in Figure 37 on page 32 and marked with ‘AUX’. The auxiliary connector contains the following interfaces:

- RS-422 serial interface
- 2 x External (I/O)

The auxiliary connector pin out and auxiliary cable wire color and designation are illustrated in Figure 39, Figure 40, and in Table 5.



Figure 39: AUX connector (pin out)



Figure 40: AUX cable (pin out)

Auxiliary (AUX) Cable		
Pin No.	Wire Color	Wire Designation
1	Black	External Output
2	Brown	External Output
3	Red	RS-422 Z (output) Tx-
4	Orange	RS-422 Y (output) Tx+
5	Yellow	RS-422 A (input) Rx+
6	Green	RS-422 B (input) Rx-
7	Blue	External Input
8	Violet	External Input
9	Gray	Not Used
10	White	RS422 (C) common

Table 5: AUX cable (wire color designation)

NOTE: Use only the 91-100768 Auxiliary Cable, 3m delivered by Lars Thrane A/S for connecting to the auxiliary connector on the backside of the LT-3110S Control Unit. The Auxiliary Cable, 3m is an accessory part and must be ordered separately.

The LT-3110S Control Unit is supporting external ringer functionality on the Auxiliary (External I/O) interface, which can be configured from the web server, see *External I/O* on page 196.

The LT-3110S Control Unit is supporting GNSS, BAM, and MSI data on the Auxiliary (RS-422) interface, which can be configured from the web server, see *GNSS, BAM and MSI* on page 197.

External Output and Input are further described on the next pages.

RS-422 Circuit Diagram (LT-3110S CU - Aux connector)

Figure 41 shows the RSS-422 circuit diagram used for the LT-3110S Control Unit (Aux connector).

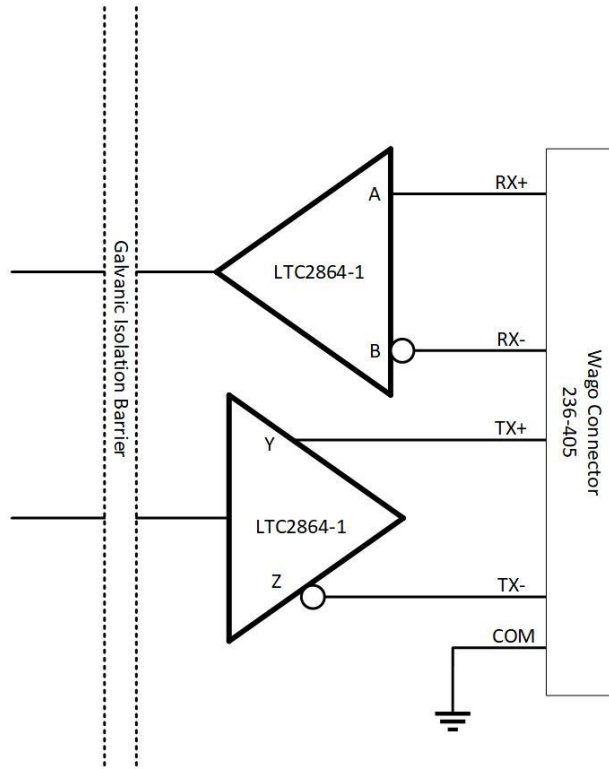

Figure 41: RS-422 Circuit Diagram for the LT-3110S CU

Interface Drive Capability as a Talker and Listener:

- A (Rx+), B (Rx-), Y (Tx+), Z (Tx-): -60V to +60V
- Short circuit protected
- Galvanic isolated up to 1500V

External Output (External Ringer)

The LT-3100S GMDSS system support connection of an external speaker for incoming call notifications. Connection of the external speaker must be completed as illustrated in Figure 42, incl. a relay. The maximum voltage and current for the relay are documented on the figure. External Output (Pin 2) and External Output (Pin 1) designation and wire colors are listed in Table 5 on page 36.

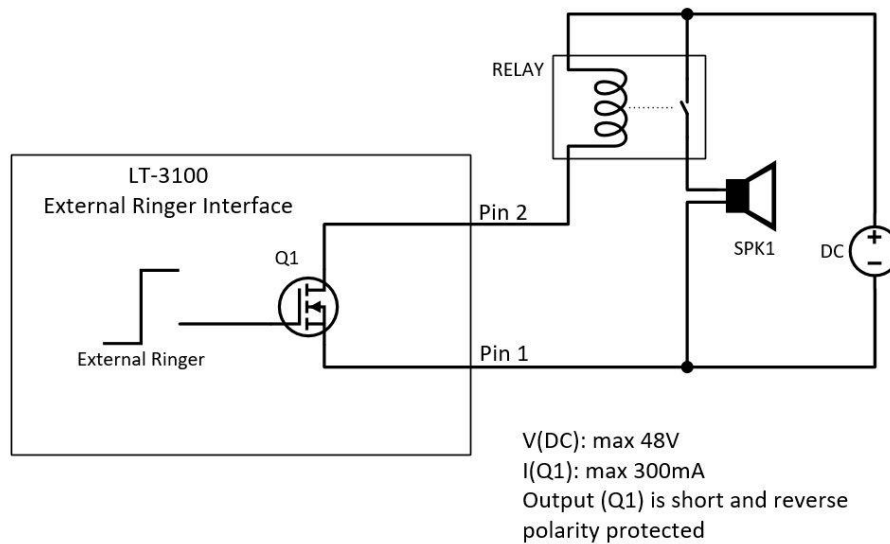

Figure 42: External I/O (external ringer diagram)

NOTE: The External Ringer functionality must be configured using the web server, Configuration - External I/O, see *External I/O* on page 196.

External Input

The LT-3100S GMDSS system is not supporting any functionality for the External I/O Input.

RS-422 (GNSS, BAM, and MSI)

The LT-3100S GMDSS system Auxiliary RS-422 (bi-directional) interface can be configured to support different functions. The following functions are supported:

- GNSS (see *GNSS sentences* on page 173)
- BAM (see *BAM sentences* on page 174)
- MSI (see *MSI sentences* on page 175)

The RS-422 interface can be configured using the web server, see *GNSS, BAM and MSI* on page 197.

N Connector (ANT)

The LT-3110S Control Unit has a N Connector (male) connector for the interface to the LT-3130 Antenna Unit. The N connector interface is providing data communication and power to the antenna unit over a coaxial cable. The N connector marked with 'ANT' is illustrated in Figure 37 on page 32.

NOTE: Do not connect or disconnect the antenna cable when the LT-3110S Control Unit is powered.

LT-3130 Antenna Unit

The LT-3110S Control Unit and the LT-3130 Antenna Unit must be connected using a coaxial cable. Both the control unit and the antenna unit have a N connector (female) mounted. This section will specify the requirements to the coaxial cable. The RF and DC requirements are specified in Table 6 and Table 7.

RF Coaxial Cable Requirements	
Requirement	Specification
Cable impedance	50 Ω
Maximum signal loss	45 dB/100 m @ 1.5 GHz

Table 6: RF Coaxial Cable Requirements

In most cases it will be the DC resistance that will determine the maximum length of the coaxial cable. It is important to note that the input voltage of the control unit is important for the length of the coaxial cable that can be used.

DC Coaxial Cable Requirements	
Power Source	Maximum DC Resistance
12 VDC	1.7 Ω
24 VDC	5.5 Ω

Table 7: DC Coaxial Cable Requirements

NOTE: The DC coaxial cable resistance that is listed in Table 7 and used to calculate the maximum cable length is the sum of the DC inner conductor resistance and the DC outer conductor resistance. Some data sheets are not providing enough information about the DC resistance, in which cases, the cable manufacture must be approached to obtain this information.

Lars Thrane A/S has calculated the maximum allowed cable lengths with two coaxial cables as illustrated in Table 8. The two coaxial cables are FF195LSFROH (~RG-58) and FF400LSFROH (~RG-214/LMR400).

Maximum Coaxial Cable Length		
Cable Type	12 VDC Supply	24 VDC Supply
FF195LSFROH (4.9mm)	41 m	135 m
FF400LSFROH (10.3mm)	154 m	500 m

Table 8: Maximum coaxial cable length (cable examples)

The cable lengths calculated in Table 8 are obtained by using the maximum DC resistance [Ω] from Table 7 and compare these maximum DC requirements with the actual DC resistance [Ω/km] of the specific coaxial cables. The FF400LSFROH and FF195LSFROX total DC resistance numbers are listed in Table 9 on page 41.

The total DC resistance for the two cables (FF195LSFROH and FF400LSFROH) are:

Total DC Resistance (Inner and Outer Conductor)			
Cable Type	Inner Conductor DC Resistance [Ω /km]	Outer Conductor DC Resistance [Ω /km]	Total DC Resistance [Ω /km]
FF195LSFROH (4.9 mm)	24.9	15.8	40.7
FF400LSFROH (10.3 mm)	4.5	6.5	11

Table 9: Total DC resistance (cable examples)

IMPORTANT: If using a coaxial cable that is different to what is specified in this section (FF195LSFROH and FF400LSFROH), then verify that the RF and DC coaxial cable requirements (Table 6 and Table 7) are respected and calculate the maximum cable length as a function of the input voltage and the total DC resistance. Contact Lars Thrane A/S to get assistance on selection and acceptance of a specific coaxial cable.

NOTE: The LT-3110S Control Unit must be powered off when connecting or disconnecting the LT-3130 Antenna Unit.

LT-3140S Interface Unit

The LT-3140S Interface Unit is designed for indoor mounting and connected to the LT-3110S Control Unit via an Ethernet cable. The LT-3140S Interface Unit specifications are available in *App. H - Specifications* on page 228. Cable strain relief must be used for securing all cables connected to the LT-3140S Interface Unit.

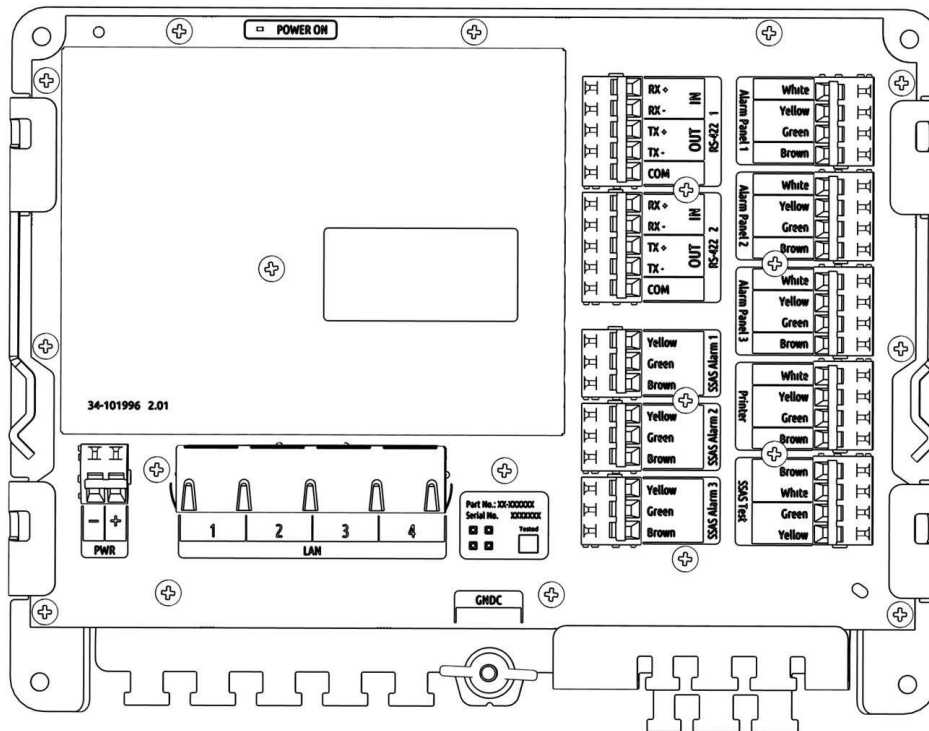

Figure 43: LT-3140S Interface Unit

The LT-3140S Interface Unit interfaces and number of interfaces are listed in Table 10.

LT-3140S Interface Unit		
Interface	Number of Interfaces	Name
Ethernet	4	LAN 1 to 4
RS-422	2	RS-422 1 and RS-422 2
GPIO	4	SSAS Alarm 1 to 3, and SSAS Test
CAN	4	Alarm Panel 1 to 3, and Printer Adapter
DC input	1	PWR (12 or 24 VDC input)
Chassis ground	1	GNDC (connect to vessel ground)

Table 10: LT-3140S Interface Unit

The LT-3140S Interface Unit must be used if connecting LT-3150S Alarm Panel, LT-3160S Printer Adapter, SSAS Alert button, or SSAS Test button. The two RS-422 bi-directional interfaces can be used for GNSS, BAM, and MSI, which is further described in *Serial Interface (RS-422)* on page 173 and the configuration in the *Web server* on page 177. The LT-3110S Control Unit also has a RS-422 interface to support these functions. The layout of the LT-3140S Interface Unit (incl. labels) is illustrated in Figure 44 on page 43. Interface name and wire color descriptions are available on all interfaces to make the connection easy.

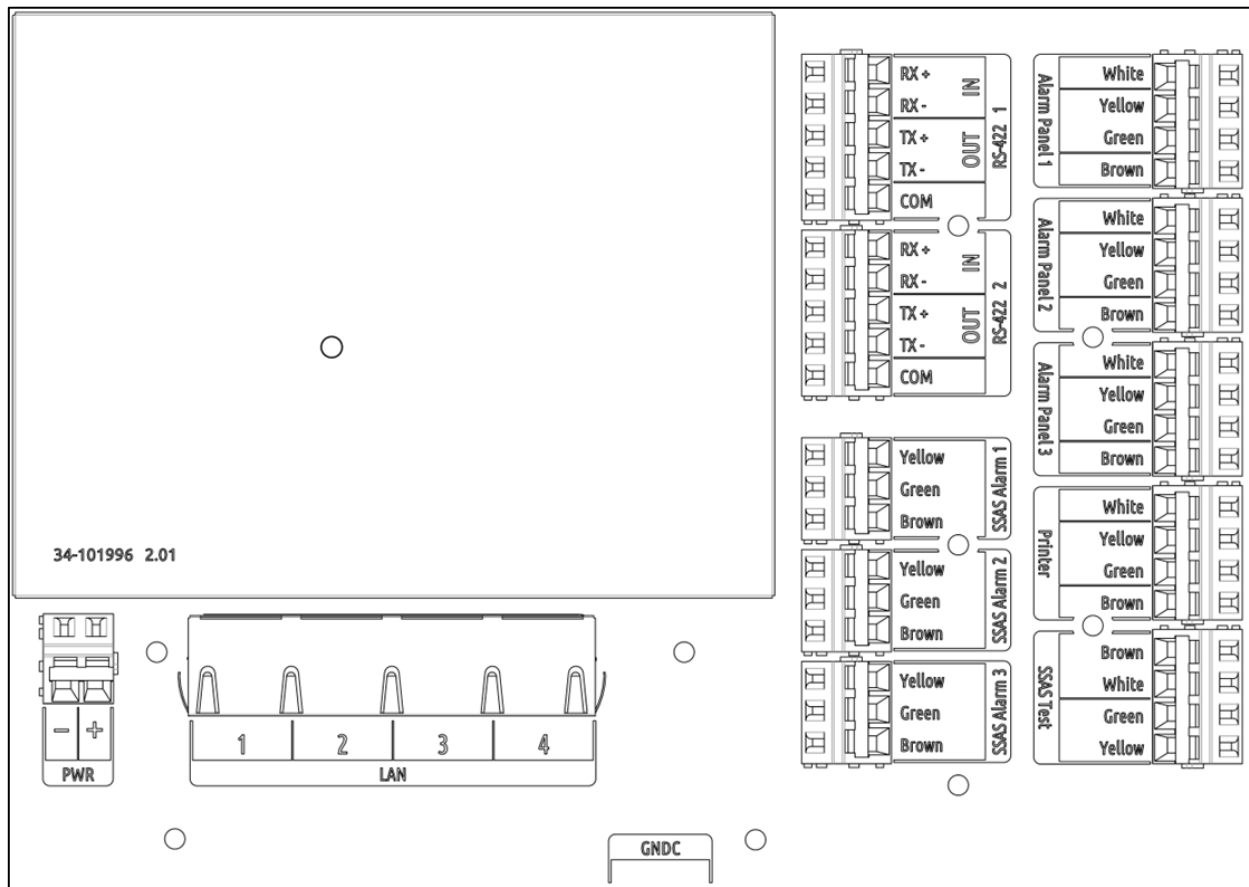

Figure 44: LT-3140S Interface Unit (with interface labels)

3 x spare Ethernet (LAN) interfaces are available on the LT-3140S Interface Unit to support future information protocols. It is possible to service the LT-3100S GMDSS system by connecting an external PC to one of these spare LAN ports (e.g. for software update of the system or downloading a diagnostic report).

NOTE: LT-3100 GMDSS system is permitted to be connected to an IEC 61162 Ethernet network.

NOTE: All RS-422 interfaces of both the LT-3110S Control Unit and LT-3140S Interface Unit are compliant with IEC 61162-1, IEC 61162-2 and IEC 61162-450. BAM can only be activated on a single RS-422 interface.

RS-422 Interface (LT-3140S IU - RS-422 1 and RS-422 2)

The RS-422 interfaces supported from the LT-3140S Interface Unit are shown in Table 11 and Table 12.

LT-3140S IU (RS-422 1)	
Pin Connector Name	Signal Designation
Rx+	RS-422 A (input)
Rx-	RS-422 B (input)
Tx+	RS-422 Y (output)
Tx-	RS-422 Z (output)
COM	RS-422 (C) common

Table 11: LT-3140S IU (RS-422 1)

LT-3140S IU (RS-422 2)	
Pin Connector Name	Signal Designation
Rx+	RS-422 A (input)
Rx-	RS-422 B (input)
Tx+	RS-422 Y (output)
Tx-	RS-422 Z (output)
COM	RS-422 (C) common

Table 12: LT-3140S IU (RS-422 2)

RS-422 Circuit Diagram (LT-3140S IU - RS-422 1 and RS-422 2)

Figure 45 shows the RSS-422 circuit diagram used for the LT-3140S Interface Unit (RS-422 1 and RS-422 2).

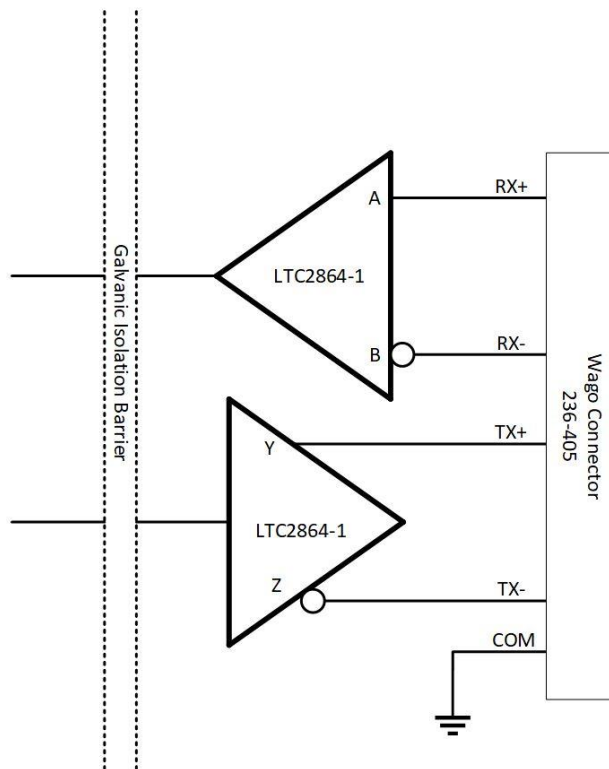

Figure 45: RS-422 Circuit Diagram for the LT-3140S IU

Interface Drive Capability as a Talker and Listener:

- A (Rx+), B (Rx-), Y (Tx+), Z (Tx-): -60V to +60V
- Short circuit protected
- Galvanic isolated up to 1500V

DC input (PWR)

The LT-3140S Interface Unit is designed to be used on 12 VDC and 24 VDC power buses (nominal). External DC power to the LT-3140S Interface Unit is provided by connecting a DC cable (plus/minus), incl. crimp tubes, to the DC input power connector. The power connector on the LT-3140S Interface Unit is marked with 'PWR'. All connectors on the LT-3140S Interface Unit are hidden below a front cover as illustrated in Figure 18 on page 20.

The power source for the LT-3100S GMDSS System must comply with the GMDSS regulations and the associated standards, minimum is compliance to IEC 60945 (2002). The power source to LT-3110S Control Unit and the LT-3140S Interface Unit must be connected to the main and emergency source of power as required by SOLAS reg II-1/42 or /43, and a battery backup system. When extending the power supply cables the positive (+) and the negative (-) must be installed closely together in order to keep the cable inductance low.

NOTE: Make sure to use a galvanic isolated power supply as illustrated in *Galvanic Isolated Power Supply* on page 50.

NOTE: The input voltage range is: 12-24 VDC (0.7-0.4A). The LT-3140S Interface Unit DC input connector and circuit is protected and certified for Reverse Polarity Protection.

Chassis ground (GNDC)

The chassis ground connector is placed underneath the front cover of the LT-3140S Interface Unit and marked with 'GNDC', see Figure 43 on page 42.

IMPORTANT: Only DC input power: 12 to 24 VDC must be applied on the LT-3140S Interface Unit. Crimp tubes on the DC power cable must be used.

Power Consumption

The LT-3100S GMDSS system is powered from 12 VDC or 24 VDC power source. This section will provide power consumption details for maximum power consumption and typical average power consumption to be used for calculating the back-up battery capacity, which is a requirement for GMDSS equipment onboard SOLAS vessels.

Maximum

The LT-3100S GMDSS system maximum power consumption is listed in Table 13 and in Table 14. The maximum power consumption is calculated with activity on all interfaces. The LT-3130 Antenna Unit has a built-in heater, which is activated only when the 24 VDC input power source is available.

24 VDC Maximum Power Consumption (Watt)	
System Unit	Power [W]
LT-3110S CU	40.8
LT-3140S IU	10.0
Total Power (maximum)	50.8

Table 13: Maximum Power Consumption (24 VDC input)

12 VDC Maximum Power Consumption (Watt)	
System Units	Power [W]
LT-3110S CU	26.4
LT-3140S IU	10.0
Total Power (maximum)	36.4

Table 14: Maximum Power Consumption (12 VDC input)

The coaxial cable length is an adding factor to the total power consumption of the system. A short coaxial cable will add approximately ~0 W to the total power consumption. Whereas a coaxial cable with a maximum length will add ~16 W (24 VDC input) and ~10 W (12 VDC input) to the total power consumption. The supported coaxial cable lengths for the LT-3100S GMDSS system are described in *LT-3130 Antenna Unit* on page 40.

Average (transmission/reception)

The average power consumption for the LT-3100S GMDSS system is listed in Table 15 and Table 16. These power consumption numbers must be used for calculating the battery capacity for GMDSS equipment in accordance with the respective IMO resolution and guidelines.

24 VDC Typical Average Power Consumption (Watt)			
System Units	Transmission [W]	Reception [W]	Comments
LT-3110S CU	37.8	37.8	Maximum cable length.
LT-3140S IU	7.0	7.0	
Total Power (average)	44.8	44.8	

Table 15: Average Power Consumption (24 VDC)

12 VDC Typical Average Power Consumption (Watt)			
System Units	Transmission [W]	Reception [W]	Comments
LT-3110S CU	23.4	17.4	Maximum cable length.
LT-3140S IU	7.0	7.0	
Total Power (average)	30.4	24.4	

Table 16: Average Power Consumption (12 VDC)

NOTE: The average power consumption (transmission/reception) is illustrated with maximum coaxial cable length used in Table 15 and Table 16. Using a shorter coaxial cable, will significantly reduce the total power consumption as illustrated in Table 17.

Example: Typical Average Power Consumption 24 VDC (Coaxial Cable FF400LSFROH - 25 to 500m):

This example is illustrating the typical average power consumption for a LT-3100S GMDSS system ($V_s = 24$ VDC), where 25 to 500m coaxial cable (FF400LSFROH) is listed. The LT-3100S GMDSS system is including the LT-3140S Interface Unit.

24 VDC Typical Average Power Consumption (Watt)			
Cable Length	Transmission [W]	Reception [W]	Comments
25m	~30.0	~30.0	
50m	~31.0	~31.0	
100m	~33.0	~33.0	
200m	~35.0	~35.0	
500m	~45.0	~45.0	Maximum cable length.

Table 17: Example of Typical Average Power Consumption (24 VDC)

DC Isolation Resistance and Chassis Ground

The LT-3100S GMDSS system must be installed properly with respect to DC isolation resistance and chassis ground. Wrong installations can lead to DC isolation issues (low Ohm meter measuring) on board the vessel and equipment damages. This section will provide details about installation precautions, which must be followed.

LT-3110S Control Unit (back view) with an upscaled power connector are illustrated in Figure 46. The Chassis ground (GNDC) must be connected sufficiently to the vessel ground. 91-102218 Power Cable, 3m must be used to connect the LT-3110S Control Unit to the vessel 12 or 24 VDC power source. DC isolation resistance measured on a disconnected LT-3110S Control Unit between GNDC and VDC (-) > 50 MΩ.

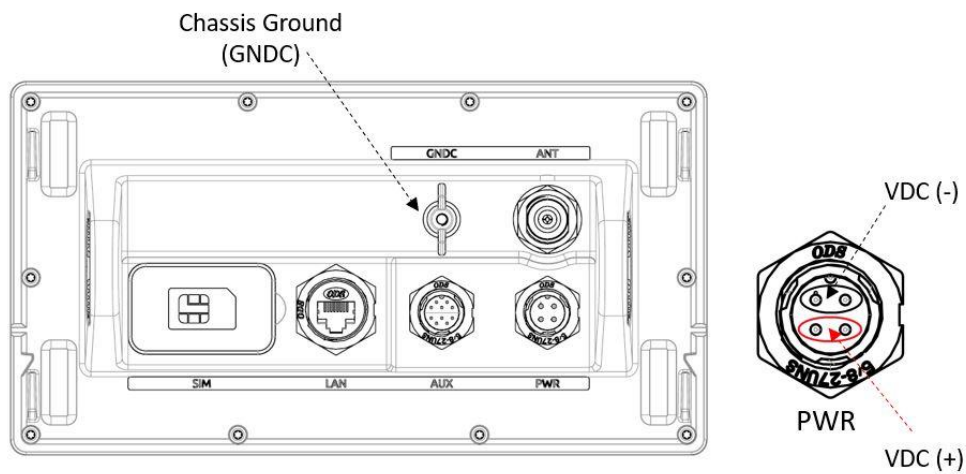

Figure 46: LT-3110S Control Unit (VDC(+), VDC(-), and GNDC)

The LT-3130 Antenna Unit (bottom view) is illustrated in Figure 47. Chassis ground (GNDC) on the LT-3130 Antenna Unit is defined as the mechanics (connected to the mounts).

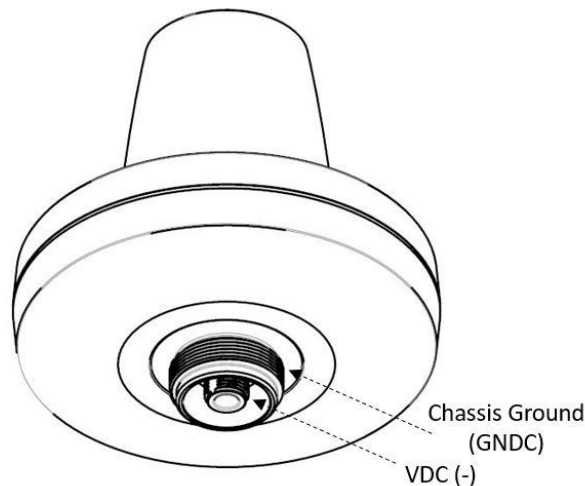

Figure 47: LT-3130 Antenna Unit (VDC(+), VDC(-), and GNDC)

DC isolation resistance measured on a disconnected LT-3130 Antenna Unit between GNDC and VDC (-) > 50 MΩ. VDC (-) and VDC (+) is respectfully the N connector thread and the N connector center conductor. Figure 48 is illustrating the LT-3100S GMDSS system consisting of LT-3110S Control Unit, LT-3130 Antenna Unit, and the coaxial cable connecting these two units.

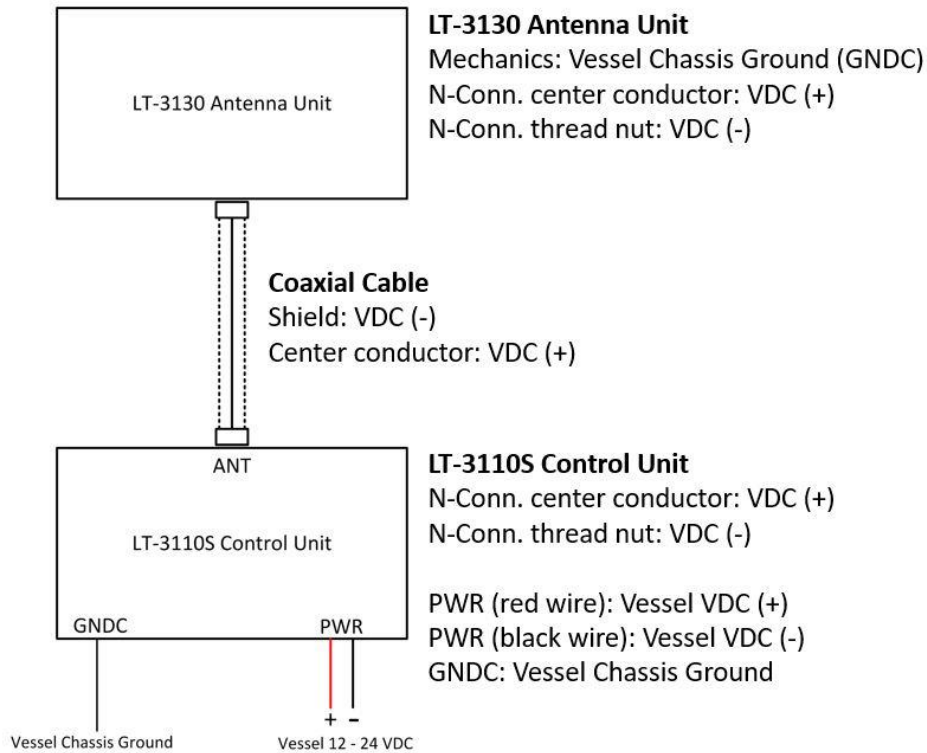

Figure 48: Definitions of VDC (+), VDC (-), and GNDC

It is important that the coaxial cable, connected to both the LT-3110S Control Unit and LT-3130 Antenna Unit, is not grounded in any of the ends. Do not connect the coaxial cable shield to vessel ground. The coaxial cable N connector must only be connected directly to the N connector of the two units.

NOTE: Make sure that the LT-3130 Antenna Unit is connected sufficiently to vessel ground. Also, make sure that the N connector on the LT-3130 Antenna Unit, VDC (-) is not connected to the LT-3130 Antenna Unit mechanics, GNDC. It is important to adhere to this requirement so as not to get a bad DC isolation resistance.

Galvanic Isolated Power Supply

Use an IEC 60945 approved AC/DC or DC/DC galvanic isolated power supply for the LT-3100S GMDSS system (LT-3110S Control Unit and LT-3140S Interface Unit). The galvanic isolated power supply must be used to protect the LT-3100S GMDSS.

AC/DC Galvanic Isolated Power Supply

Connection of an AC/DC galvanic isolated power supply is illustrated in Figure 49.

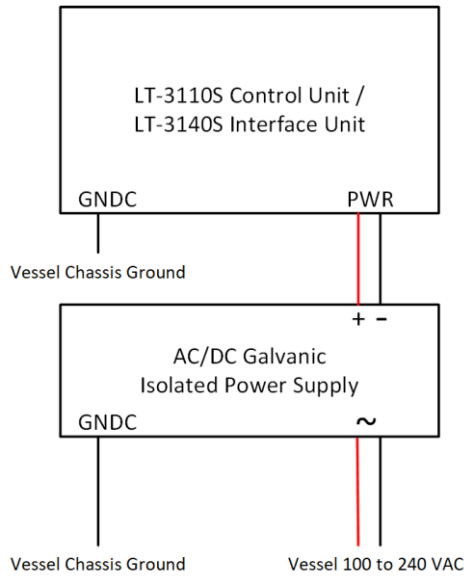

Figure 49: AC/DC Galvanic Isolated Power Supply

DC/DC Galvanic Isolated Power Supply

Connection of an DC/DC galvanic isolated power supply is illustrated in Figure 50.

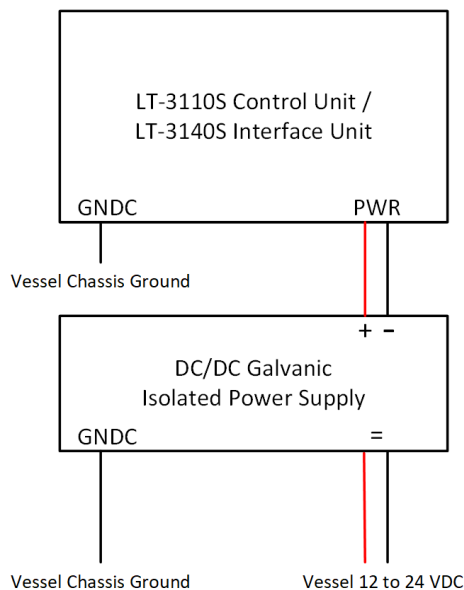

Figure 50: DC/DC Galvanic Isolated Power Supply

User Interface (UI)

The LT-3100S GMDSS system is controlled from the LT-3110S Control Unit, which is the interface for operating and configuring the system. The control unit has a 4.3" TFT-LCD display, supporting day and night modes. The layout of the display and buttons are illustrated in Figure 51.

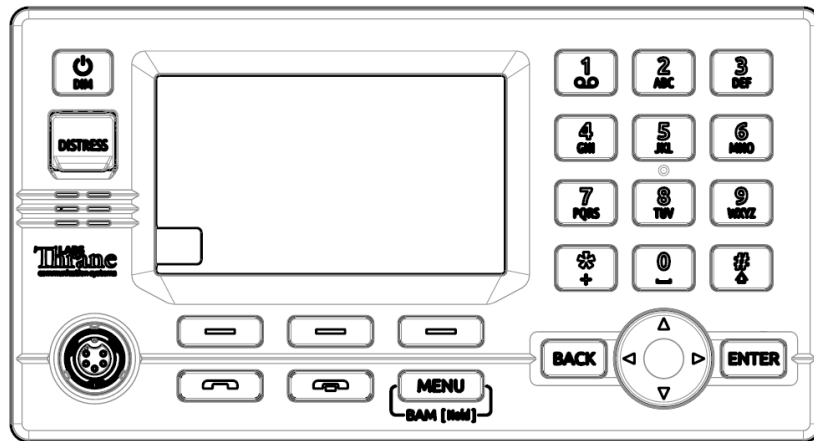

Figure 51: Control Unit (front view) - user interface display and buttons.

The control unit buttons, functions and features, are described in the following groups:

- **Power & DIM button:** The power button can restart the system by pressing the button for 5 seconds. A pop-up box will show the action, and a counter will count down until the system is powered off. If the external power source to the system is re-powered, then the system will power on automatically. To activate the DIM functionality, short press the Power & DIM button. Short press (1 < s); brightness level will change between 7 levels. Long press (≥ 1 s); will change the display mode. The display brightness level and display mode can be changed from the menu as well (MENU -> Settings -> Display).
- **DISTRESS button:** Lift the lid and press the DISTRESS button for a minimum of 3 seconds to activate a Distress. A Distress Activated window will be visible as soon as a Distress has been activated via the DISTRESS button.
- **Off-hook button:** The button is illustrated with a green colored handset. The function of the off-hook button is to activate a call, if the dialed number is available in the display or a contact is selected in the Contacts or Call History. The off-hook button can also be used to accept an incoming call. The alternative to use the off-hook button is to lift the handset out of the cradle. If the off-hook button is used and the handset remain in the cradle, the phone audio will be available in the control unit speaker. The microphone is muted, if the handset remains in the cradle - indicated with an icon in the status bar.
- **On-hook button:** The button is illustrated with a red colored handset. Pressing the on-hook button will terminate an active call.
- **MENU / BAM button:** The MENU button is used to open the main menu. The BACK, Navigation (arrows), and ENTER buttons are used to navigate in the menu. Press the MENU button to exit the menu from anywhere in the menu tree (instead of multiple BACK button presses). Long press (> 1 s) the MENU / BAM button and the BAM Alert List will be shown.
- **Soft keys buttons:** Three soft keys are available in the bottom of the display. The soft keys are used for different purposes and their functions will change in the operation modes of the system.

- **Navigation buttons:** The navigation buttons (BACK, arrows, and ENTER) are used for navigation purposes in the menu layout. In context of user input or when making selections, the BACK button will erase input or cancel editing respectfully, the ENTER button will end input or apply selection respectfully.
- **Numeric Keypad buttons:** The numeric keypad buttons, the '*' button, and the '+' button can be used for entering digits, letters and special characters. Depending on context, pressing one button in rapid succession (< 1s) will cycle through a selection of letters, digits and/or special characters (e.g. when entering a phone number, pressing the '*' character twice in succession will result in one '+' character and not two '*' characters).

An icon in the status bar will show the current input mode, indicating which characters can be cycled - if any. In text mode, the '#' key is used to change between capital and lowercase letters.

Display

The display contains three sections as illustrated in Figure 52: Status bar, view area and soft keys.



Figure 52: LT-3110S Control Unit (display sections)

The essential system status and system notifications are shown in the status bar, which is always present.

The view area contains the active view. The active view is changed by navigating the UI using the MENU and navigation buttons. The text and function of the soft key's changes dynamically with the active view. The soft keys can also change without changing view depending on the activity in the active view.

The Recommended viewing distance is 68 cm, at which all data is readable under all light conditions.

The general level of the brightness can be varied through 7 steps from 5 cd/m² up to 560 cd/m² on white background in "Day mode". The display also has a "Night mode" (inverted graphics) with additional 7 steps.

It has been verified through measurements that dense text information areas on black background emits light equivalent to 1 cd/m². All measurements through all light levels in the two modes demonstrates a minimum contrast level of 350:1.

The status bar has a dedicated section for presenting time and position and 7 slots for system status icons.

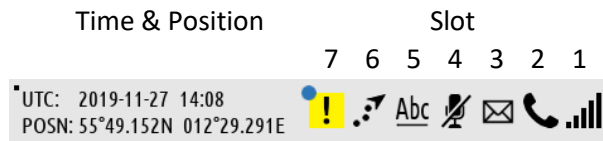

Figure 53: LT-3110S Control Unit (status bar)

NOTE: The status bar contains a flashing square in the upper left corner to verify that the display never freezes, see Figure 53 on page 53. The flashing square is always visible on the display. The square is not illustrated on other figures throughout this manual.

Each slot shows the status of one function or group of functions. If a group of functions in a slot has more than one active icon, the slot will continuously take turn showing one icon at a time for a few seconds before cycling to the icon of the next function.

Network Status - Slot 1	
	The LT-3100 system has no satellite signal and is not registered on the Iridium® Network.
	The LT-3100 system has satellite signal = 0 and is registered on the Iridium® Network.
	The LT-3100 system has satellite signal = 1 and registered on the Iridium® Network.
	The LT-3100 system has satellite signal = 5 and registered on the Iridium® Network.

Table 18: LT-3110S Control Unit - status bar (network status)

Iridium Service - Slot 2	
	Active voice call or off-hook mode.
	An external (SIP) phone is in an active voice call.
	There is an active data connection.

Table 19: LT-3110S Control Unit - status bar (Iridium service)



Notifications - Slot 3	
	There are one or more missed calls.
	There are one or more unread MSI messages, Safety Messages, SMS or E-mail messages.

Table 20: LT-3110S Control Unit - status bar (notifications)

Audio - Slot 4	
	The microphone on the handset is muted.

Table 21: LT-3110S Control Unit - status bar (audio)

Input Mode - Slot 5	
<u>123</u>	The numeric keypad can be used to enter a phone number or numeric number.
<u>Abc</u>	The numeric keypad can be used to enter text. The first letter of a sentence will be in upper case.
<u>abc</u>	The numeric keypad can be used to enter text. All letters will be in lower case.
<u>ABC</u>	The numeric keypad can be used to enter text. All letters will be in upper case.

Table 22: LT-3110S Control Unit - status bar (input mode)

Miscellaneous Functions - Slot 6	
	The Tracking service is enabled and in periodic mode or enabled and in manual mode currently sending a report.

Table 23: LT-3110S Control Unit - status bar (miscellaneous functions)







BAM Status - Slot 7	
	Active - unacknowledged warning
	Active - silenced warning
	Active - acknowledged warning
	Active - responsibility transferred warning
	Rectified - unacknowledged warning
	Active caution

Table 24: LT-3110S Control Unit - status bar (BAM status)

Menu System

The LT-3100S GMDSS system main menu is opened by pressing the MENU button on the keypad. The user will be presented with a layout as illustrated in Figure 54.

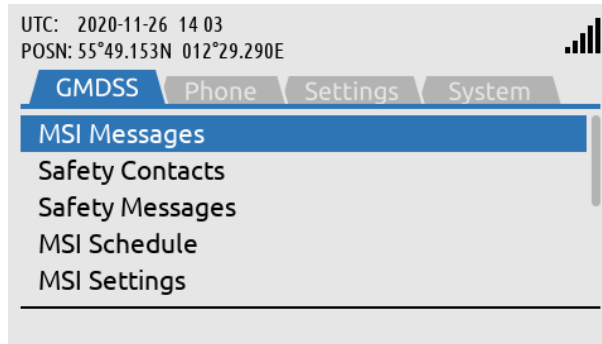
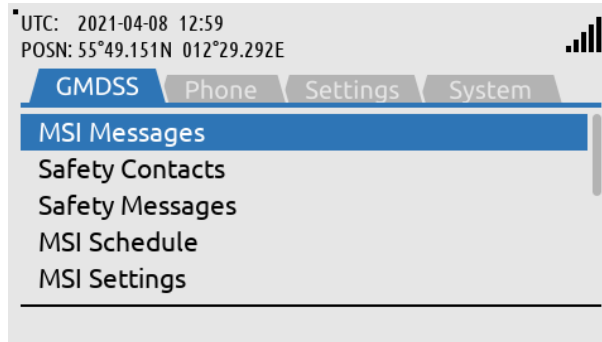

Figure 54: LT-3110S Control Unit (MENU layout)

MENU / Submenu Layout	
Submenus	Entries
GMDSS	MSI Messages Safety Contacts Safety Messages MSI Schedule MSI Settings Distress Settings Position Settings Printer Settings Location Information SES Information Terminal Test
Phone	Contacts SMS Call History Data History Phone Usage
Settings	Audio Display Date & Time Reset Options
System	BAM Alerts Network Tracking SIP Phones Position Status Subscription System Info Power Supply

Table 25: LT-3110S Control Unit (MENU and submenus)

The main menu is represented by four submenus: GMDSS, Phone, Settings, and System. The four submenus are listed in Table 25.



GMDSS submenu:
MENU -> GMDSS

Figure 55: GMDSS submenu

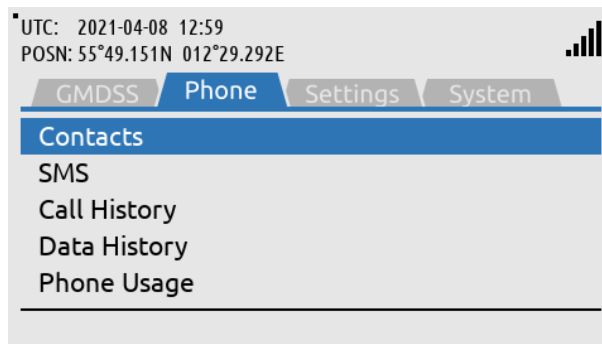

Phone submenu:
MENU -> Phone

Figure 56: Phone submenu

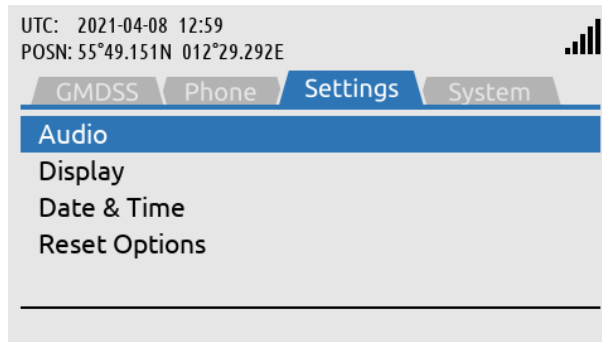

Settings submenu:
MENU -> Settings

Figure 57: Settings submenu

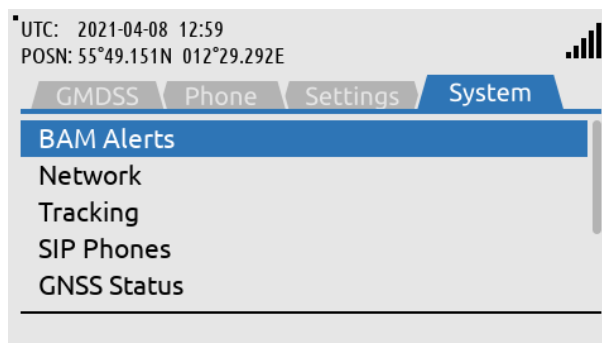

System submenu:
MENU -> System

Figure 58: System submenu

Activating the System

A few things must be completed before you can have an operational LT-3100S GMDSS system on board your vessel. It is assumed that you have received the LT-3100S GMDSS system from the Lars Thrane A/S GMDSS certified partner - this could be directly or indirectly. The Lars Thrane A/S GMDSS certified partners have completed technical training and will be able to assist you with all the questions you might have to the product or service. The Lars Thrane A/S GMDSS certified partners are listed on the company's website: <https://www.thrane.eu>

The following steps are required for activating the LT-3100S GMDSS system:

- GMDSS SIM card
- Iridium Maritime Safety Service Activation Form (MSSAF)
- Completing the Installation Wizard
- Completing Radio Survey

The LT-3100S GMDSS system installation and mounting is described in the previous sections. The LT-3100S GMDSS system must complete an Iridium MSSAF form (list the ICCID of the GMDSS SIM card and IMEI number of the LT-3130 Antenna Unit) and all the vessel details, before the Installation Wizard can be started and then activate the system on the Iridium GMDSS System (IGS).

IMPORTANT: In order for the LT-3100S GMDSS system to be deemed operational and ready for continuous service: i) it must be correctly installed per the specifications in the User & Installation Manual of the LT-3100S GMDSS Satellite Communications System ("LT-3100S GMDSS User & Installation Manual"), ii) the LT-3100S Installation Wizard must have been completed successfully, and iii) the Iridium GMDSS SIM card, which serves to evidence that a terminal has been subscribed to Iridium's Network, has been secured and correctly installed. The Iridium GMDSS SIM card is at all times required for operation of the GMDSS equipment and is a critical and indispensable part of the LT-3100S GMDSS system. Without a valid Iridium GMDSS SIM card correctly installed and continuously maintained in the inserted position in the LT-3110S Control Unit, pursuant to the instructions in the LT-3100S GMDSS User & Installation Manual, the terminal is not an operational GMDSS terminal and not ready and available for continuous use on any vessel. Vessel operators are mandated by International Maritime Organization regulations to ensure the continued operation of any GMDSS terminal (whether a primary terminal or backup unit) installed on their vessels. The Iridium GMDSS SIM card is, as previously described, required at all times for the proper operation of the Iridium LT-3100S GMDSS system and is considered a critical component of the GMDSS equipment.

Acquire a GMDSS SIM card

An Iridium GMDSS SIM card must be used for activating a LT-3100S GMDSS system. The GMDSS SIM card is described and illustrated in *GMDSS SIM card (SIM)* on page 34. The GMDSS SIM card may be acquired directly from your Lars Thrane A/S certified partner. The ICCID number (uniquely identifies the GMDSS SIM card) must be used for completing the Iridium MSSAF form. The GMDSS SIM card must be inserted in the LT-3110S Control Unit before powering up the system and starting the Installation Wizard. The Installation Wizard is described in *Installation Wizard* on page 61.

Maritime Safety Service Activation Form (MSSAF)

To complete the Iridium Maritime Safety Service Activation Form (MSSAF), you must contact your Iridium GMDSS Service Provider (SP) or Lars Thrane A/S GMDSS certified partner. The Iridium website will have an up-to-date list of approved Iridium GMDSS Service Providers (SP):

<https://www.iridium.com/services/gmdss/>

Table 26 provides an overview of the details required in order to complete the MSSAF. The Iridium GMDSS Service provider (SP) might require further details, hereunder accounting.

Maritime Safety Service Activation Form (MSSAF)	
Vessel Information	Terminal Information
Vessel Name	SOLAS Vessel (yes or no)
Vessel Type	SES1 or SES2
Vessel Build Year	IMEI (system identification)
Vessel Tonnage	ICCID (GMDSS SIM Card)
Vessel Fleet Name	Type of Terminal
Vessel Nation Flag	
Vessel IMO No.	Emergency Contact Details:
Vessel MMSI	Company / Name (incl. address)
Vessel Call Sign	Emergency Contact Name
Vessel Port of Registry	Emergency Phone
Vessel Person Capacity	Emergency E-mail

Table 26: MSSAF (details required)

IMPORTANT: The person completing the MSSAF is fully responsible for the information provided - Vessel and Terminal Information must match the actual data.

NOTE: The Iridium GMDSS Service Provider (SP) might use another wording for the Iridium Maritime Safety Service Activation Form (MSSAF). However, it is recommended referring to the MSSAF when contacting your Iridium GMDSS Service Provider (SP) or Lars Thrane A/S GMDSS certified partner.

Who's My Service Provider

Iridium has a website where they inform about the specific Service Provider (SP) who has activated the LT-3100S GMDSS system (or any other Iridium activated product).

Use the following link: <https://www.iridium.com/who-is-my-sp/>

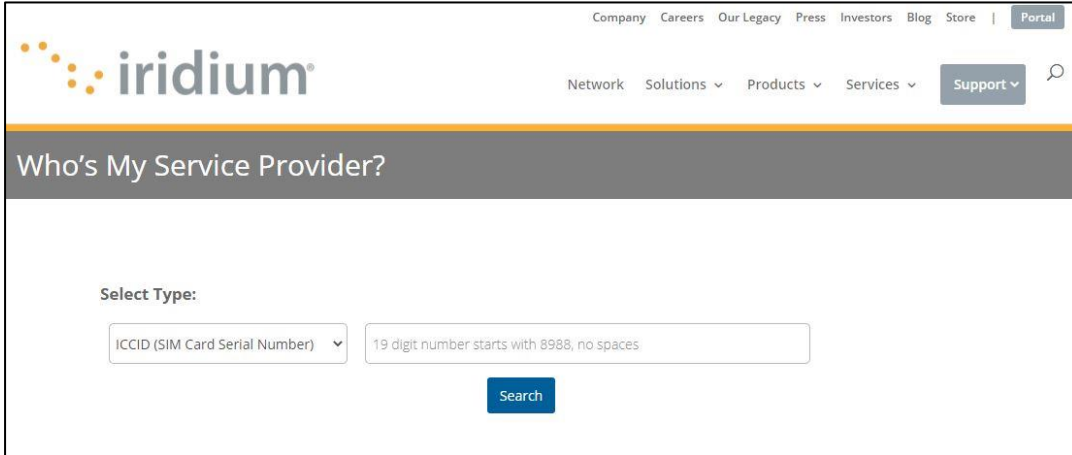

The screenshot shows the Iridium website interface for the 'Who's My Service Provider?' page. The top navigation bar includes links for Company, Careers, Our Legacy, Press, Investors, Blog, Store, and a Portal button. Below this is a secondary navigation bar with Network, Solutions, Products, Services, and a Support button with a search icon. The main content area has a dark grey header with the text 'Who's My Service Provider?'. Below the header, there is a 'Select Type:' label followed by a dropdown menu currently showing 'ICCID (SIM Card Serial Number)'. To the right of the dropdown is a text input field with the placeholder text '19 digit number starts with 8988, no spaces'. A blue 'Search' button is located below the input field.

Figure 59: Iridium - Who's My Service Provider

You can use the following information:

- ICCID (GMDSS SIM card serial number)
- MSISDN (Mobile Subscriber ISDN number)

NOTE: The Iridium GMDSS Service Provider (SP) must be contacted for any changes to the GMDSS provisioning. 'Who's My Service Provider' will inform you where your LT-3100S GMDSS system is provisioned.

Installation Wizard

The Installation Wizard must be completed after the installation has been finished and the LT-3100S GMDSS system is powered up for the first time. The Installation Wizard consist of the following steps: Detection of Wizard, MENU Key, System Settings, System Configuration, Download GMDSS Configuration, Select Distress RCC, System Verification, and System Activation, as illustrated in Table 27. The LT-3100S GMDSS system will only be fully functional and legal to operate when the Installation Wizard has been completed and the following text has been showed as an end of the Installation Wizard: 'The system is now ready for use.'

NOTE: The Iridium GMDSS System (IGS) may send the LT-3100S GMDSS system an updated GMDSS Configuration file as changes in the IGS requires this (e.g. new RCC added). The GMDSS Configuration file will automatically be pushed to the LT-3100S GMDSS system.

Installation vs. Service Wizard			
Steps	Installation Wizard	Service Wizard	Comments
Detection of Wizard	X	X	Installation or Service
MENU Key	X	-	Details available
System Settings	X	-	
System Configuration	X	X	
Download GMDSS Configuration	X	X	
Select Distress RCC	X	-	Automatic or Manual
System Verification	X	X	Distress Alert, Distress Call, MSI, Alarm Panels*and Printer*.
System Activation (OTA)	X	X	Over-the-Air (OTA)

Table 27: Installation vs. Service Wizard

NOTE: The LT-3100S GMDSS system must use a correct Iridium GMDSS SIM card, which is received and activated from a Iridium GMDSS Service Provider (SP) or a Lars Thrane A/S GMDSS certified partner. Make sure that the LT-3100S GMDSS system and the GMDSS SIM card is activated correctly prior to running the Installation Wizard, as described and illustrated in this section.

NOTE: Alarm Panels and Printer will only be verified if connected to the LT-3110S CU.

IMPORTANT: The LT-3100S GMDSS system will not be functional before the Installation Wizard has succesfully been completed. Please contact your Iridium GMDSS Service Provider (SP) or Lars Thrane A/S GMDSS certified partner to handle any potential problem.

Detection of Wizard

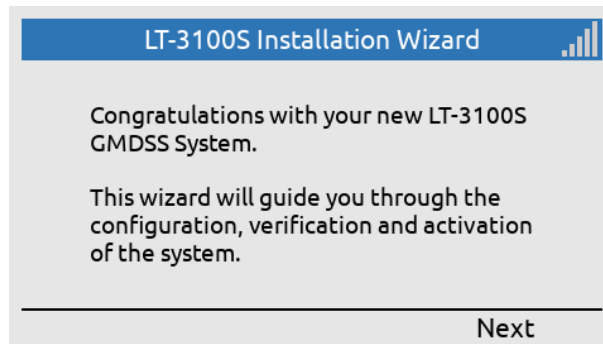

The Installation Wizard will be displayed when powering up the system initially, and until activation completed.

Figure 60: Installation Wizard (1 of 36)

MENU Key

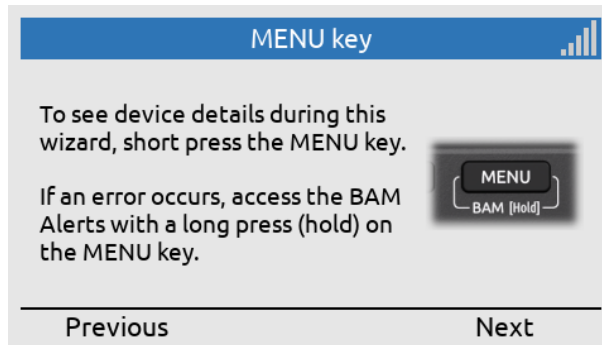

The MENU key can be used to access details (short press) during completion of the Installation Wizard.

Figure 61: Installation Wizard (2 of 36)

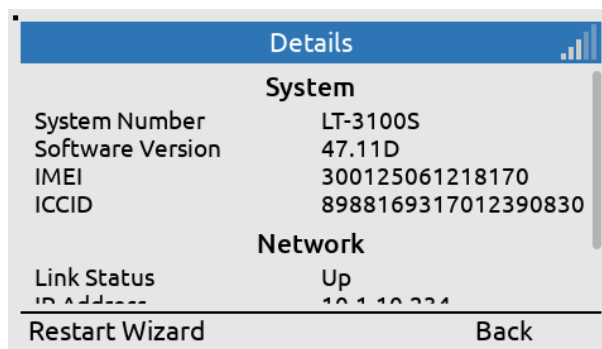

Details information (part 1 of 2).

Figure 62: Installation Wizard (3 of 36)

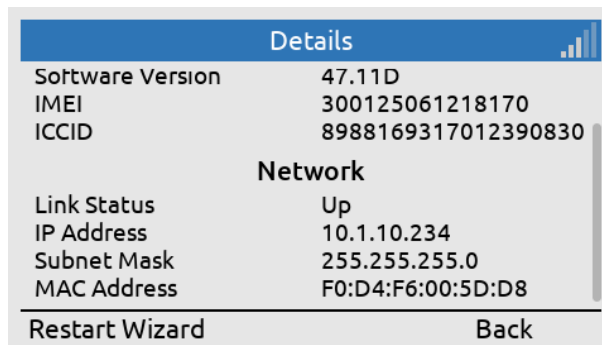

Details information (part 2 of 2).

Figure 63: Installation Wizard (4 of 36)

System Settings

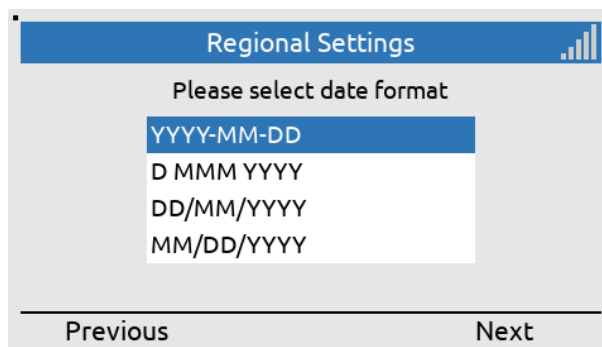

Select date format.

Figure 64: Installation Wizard (5 of 36)

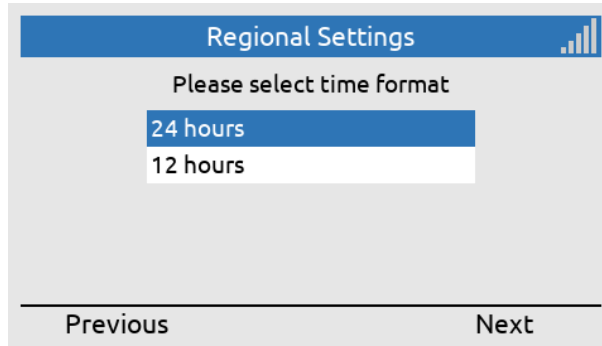

Select time format.

Figure 65: Installation Wizard (6 of 36)

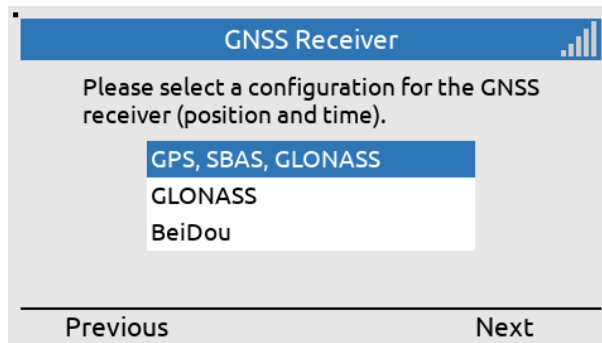

Select GNSS receiver configuration (can be configured via the web server at another time).

Figure 66: Installation Wizard (7 of 36)

System Configuration

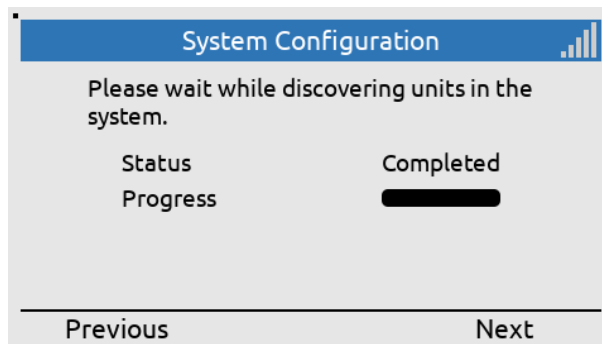

The LT-3110S CU is searching for LT-3100S GMDSS system units part of the setup.

Figure 67: Installation Wizard (8 of 36)

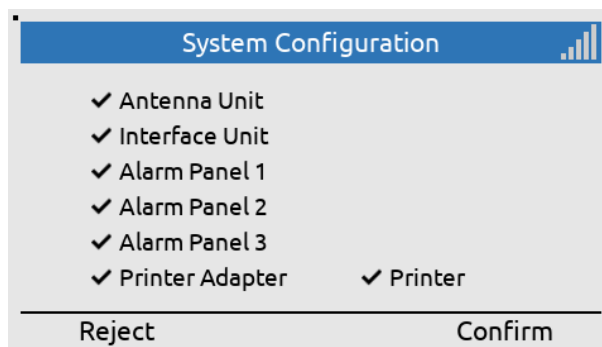

The LT-3110S CU has identified the following LT-3100S GMDSS system units, confirm to continue.

Figure 68: Installation Wizard (9 of 36)

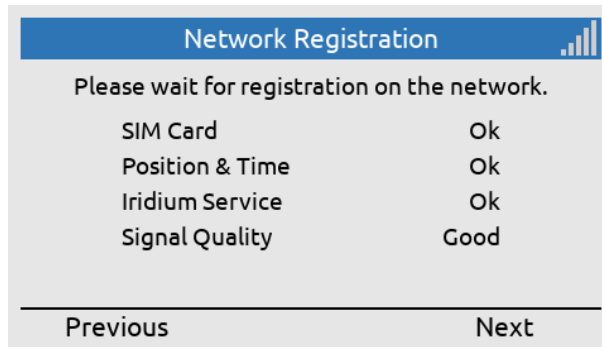

Check that everything is ready for starting the configuration of the LT-3100S GMDSS system towards the Iridium network.

Figure 69: Installation Wizard (10 of 36)

Download GMDSS Configuration

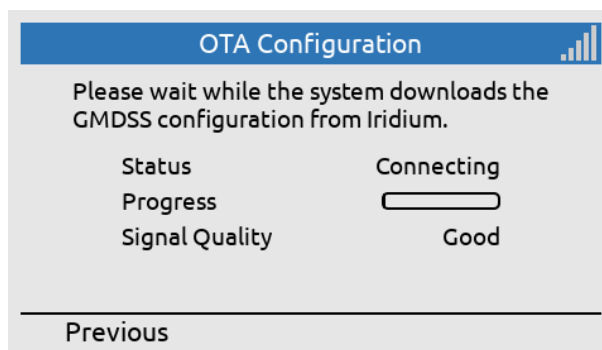

The LT-3100S GMDSS system is downloading the GMDSS Configuration file (connecting).

Figure 70: Installation Wizard (11 of 36)

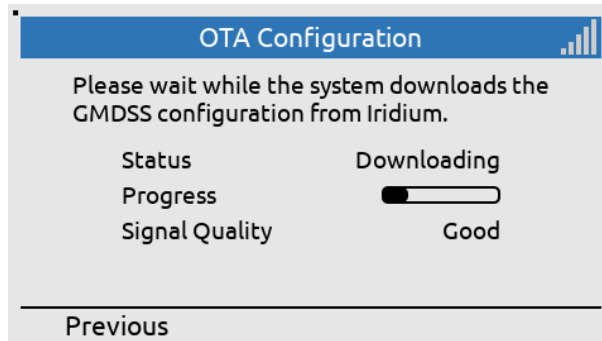

The LT-3100S GMDSS system is downloading the GMDSS Configuration file (downloading).

Figure 71: Installation Wizard (12 of 36)

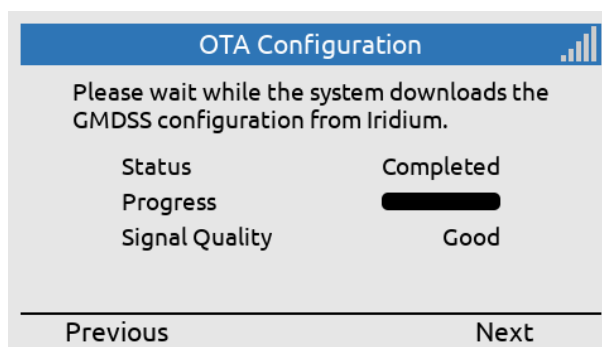

The LT-3100S GMDSS system has downloaded the GMDSS Configuration file (completed).

Figure 72: Installation Wizard (13 of 36)

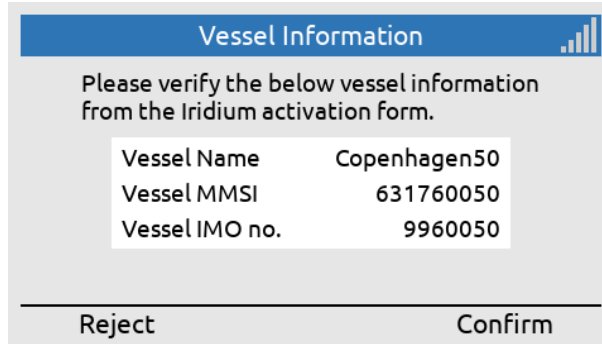

Verify the vessel details, which are provided in the Maritime Safety Service Activation Form (MSSAF) 'Iridium activation form'.

Figure 73: Installation Wizard (14 of 36)

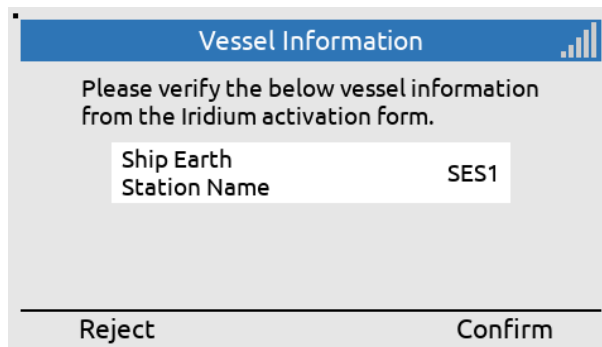

Verify the Ship Earth Station Name (SES1 or SES2).

Figure 74: Installation Wizard (15 of 36)

Select Distress RCC

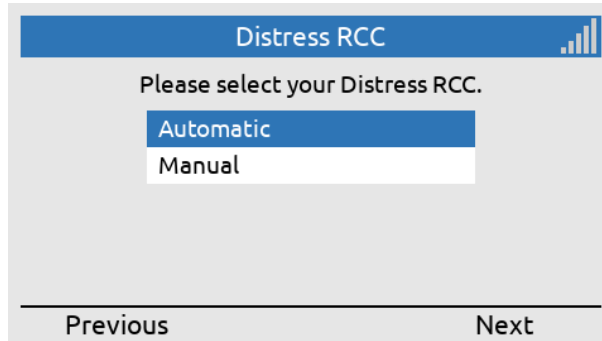

Select Distress RCC: Automatic or Manual (can be configured in Distress Settings at another time).

Figure 75: Installation Wizard (16 of 36)

System Verification

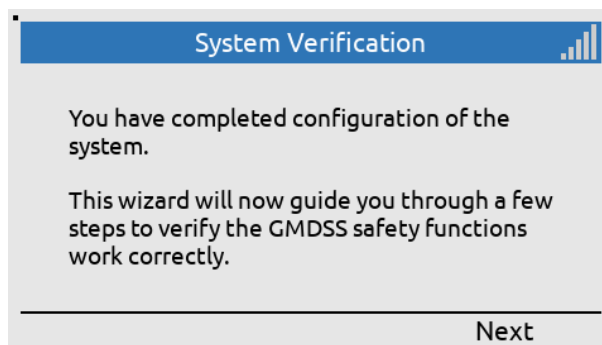

The configuration has been completed. Now the GMDSS Safety Service functions must be verified.

Figure 76: Installation Wizard (17 of 36)

IMPORTANT: The LT-3100S GMDSS system has now been configured. In order to verify that the LT-3100S GMDSS system GMDSS Safety Functions (Distress Alert, Distress Call, and MSI) are working correctly - these functions will now be tested. The LT-3100S GMDSS system is sending the Distress Alert in 'test mode'. The Distress Call will be connected to a voice prompt, reaching the Iridium GMDSS Server (IGS). A Rescue Coordination Center (RCC) will not be involved as part of the testing and verification.

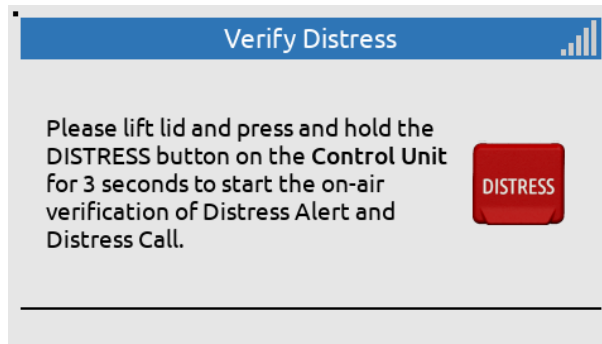

Lift the lid and press the DISTRESS button on the LT-3110S Control Unit.

Figure 77: Installation Wizard (18 of 36)

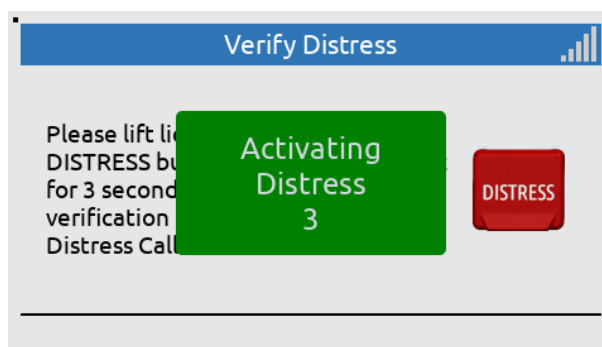

The DISTRESS button must be held for a minimum of 3 seconds to activate a Distress.

Figure 78: Installation Wizard (19 of 36)

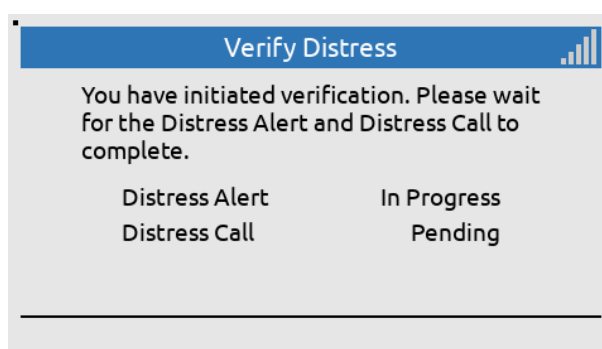

Verify Distress (CU):
Distress Alert: In progress

Figure 79: Installation Wizard (20 of 36)

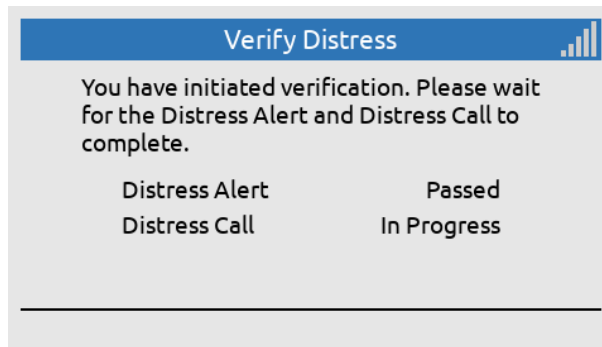

Verify Distress (CU):
Distress Alert: Passed
Distress Call: In Progress
(voice prompt available)

Figure 80: Installation Wizard (21 of 36)

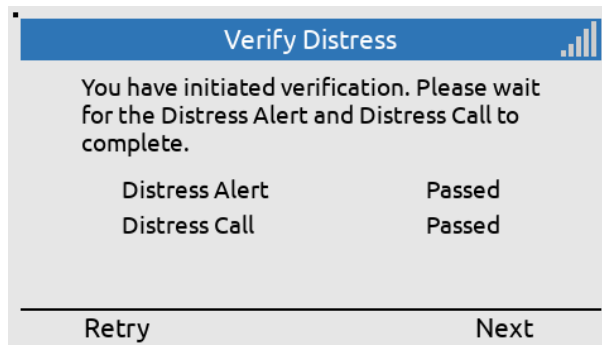

Verify Distress (CU):
Distress Alert: Passed
Distress Call: Passed

Figure 81: Installation Wizard (22 of 36)

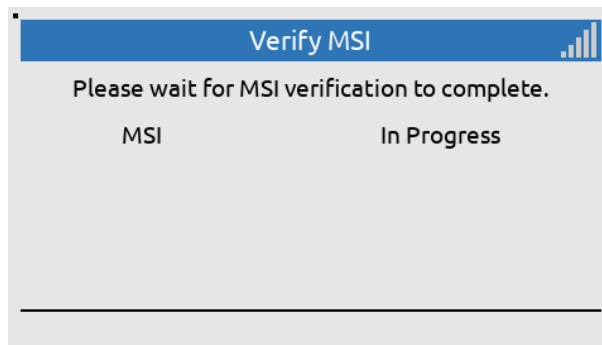

Verify MSI:
MSI: In Progress

Figure 82: Installation Wizard (23 of 36)

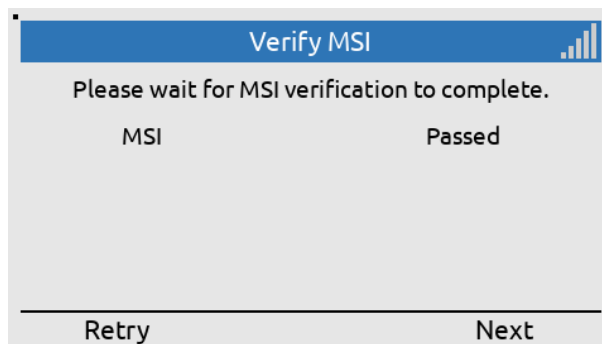

Verify MSI:
MSI: Passed

Figure 83: Installation Wizard (24 of 36)

Verification of additional units

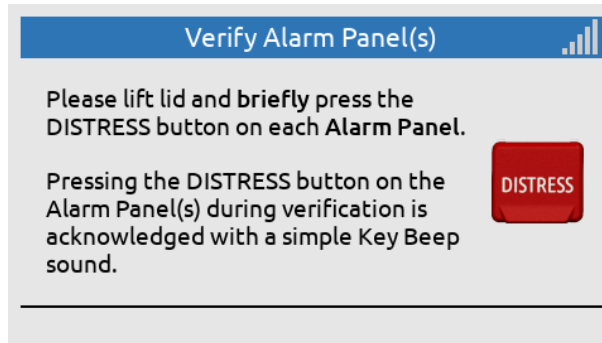

Lift the lid and do a short press (< 3 sec) of the DISTRESS button on each connected Alarm Panel

Figure 84: Installation Wizard (25 of 36)

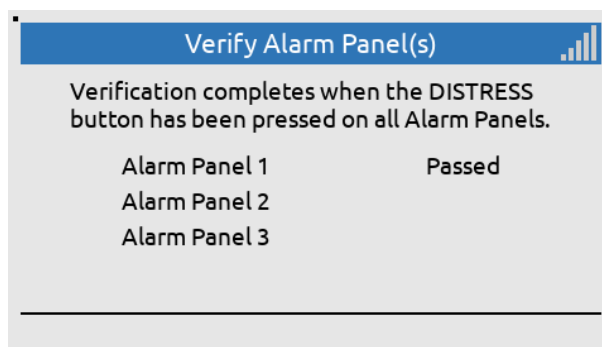

Alarm Panel 1 has passed the test. Continue by short pressing DISTRESS on the other Alarm Panels

Figure 85: Installation Wizard (26 of 36)

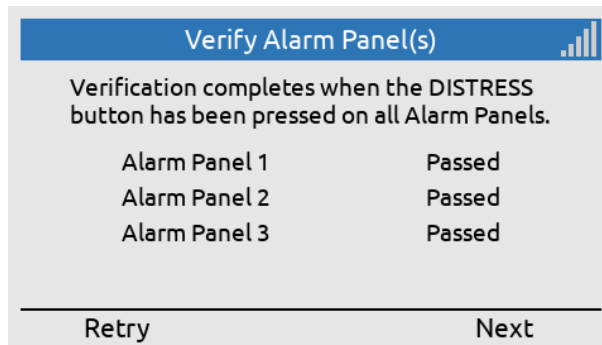

All Alarm Panels have passed the test, press Next to continue.

Figure 86: Installation Wizard (27 of 36)

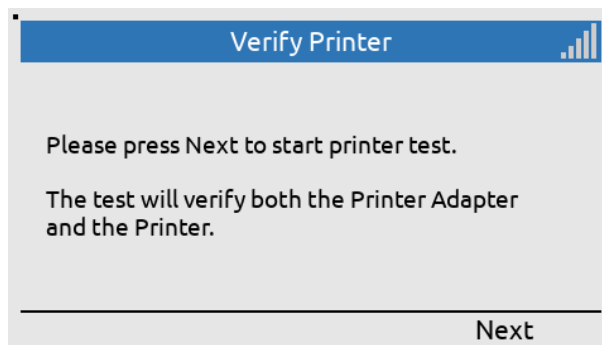

If a Printer is connected with a Printer Adaptor, the Printer is verified through the next steps

Figure 87: Installation Wizard (28 of 36)

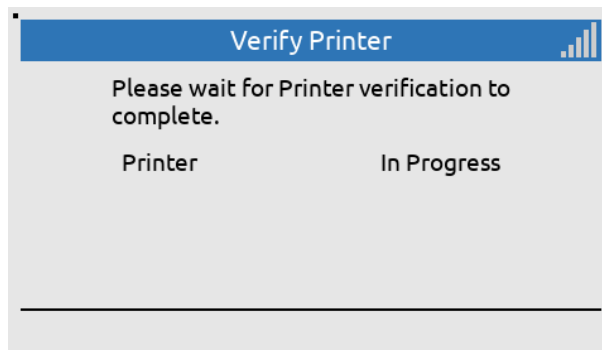

Printer verification in progress

Figure 88: Installation Wizard (29 of 36)

Test Results

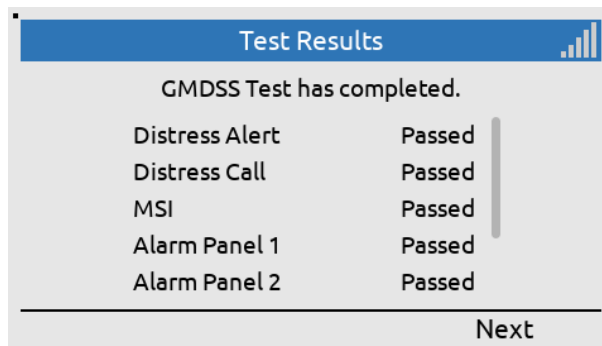

The results of the system verification are listed in the Test Results screen
Test Results (Top view)

Figure 89: Installation Wizard (30 of 36)

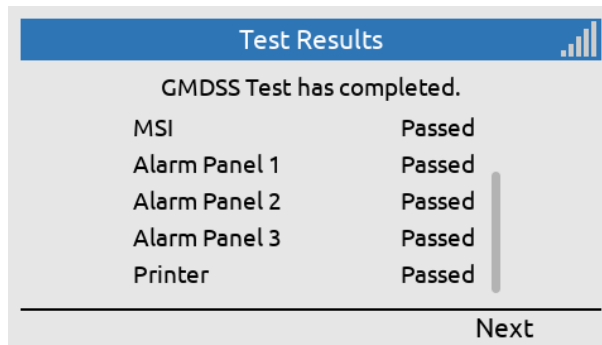

Test Results (Bottom view)

Figure 90: Installation Wizard (31 of 36)

System Activation

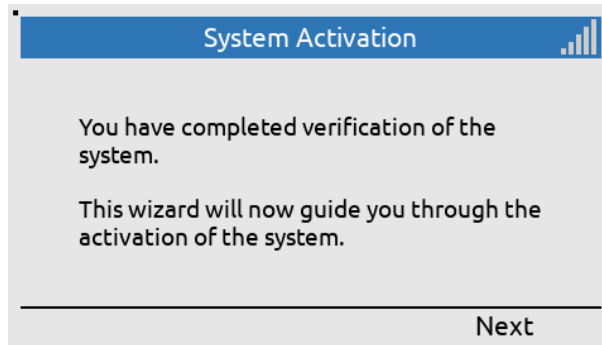

Verification of Distress GMDSS Safety Service functions have been completed successfully.

Figure 91: Installation Wizard (32 of 36)

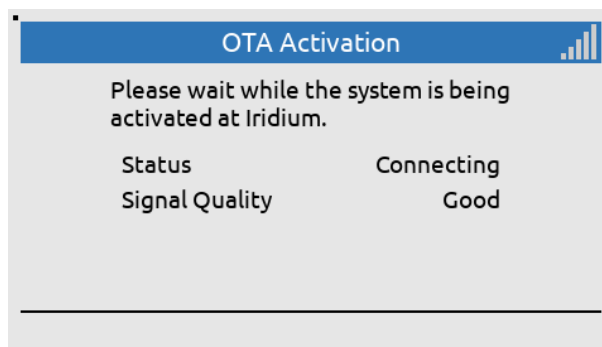

OTA Activation:
Status: Connecting
(Over-The-Air)

Figure 92: Installation Wizard (33 of 36)

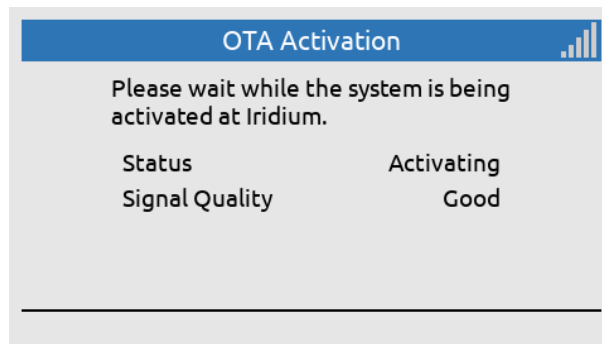

OTA Activation:
Status: Activating

Figure 93: Installation Wizard (34 of 36)

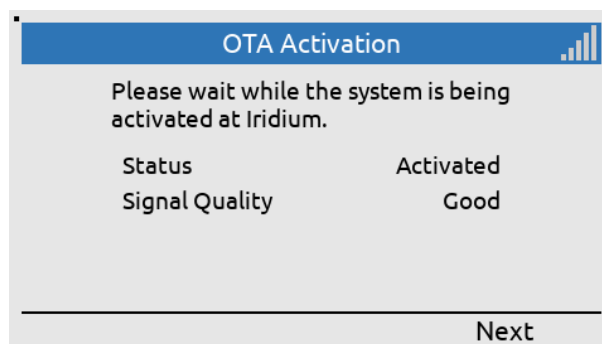

OTA Activation:
Status: Activated

Figure 94: Installation Wizard (35 of 36)

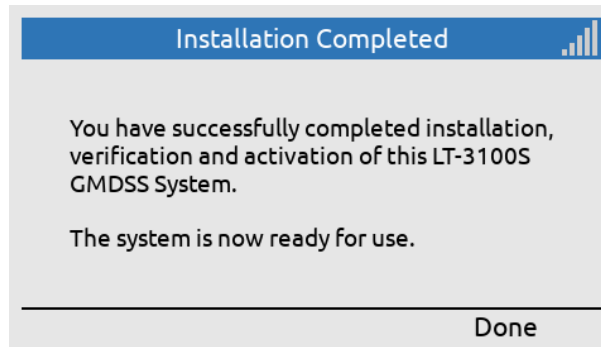

The LT-3100S GMDSS system has now been successfully activated - the system is ready for use.

Figure 95: Installation Wizard (36 of 36)

The Installation Wizard has now been completed successfully and the LT-3100S GMDSS System is now ready for use!

NOTE: The Installation Wizard will be displayed after powering up of the LT-3100S GMDSS system initially or if the system has been factory reset from the web server.

Radio Survey

Once the LT-3100S GMDSS system has been physically installed, connected, and the Installation Wizard has been completed successfully, the system must be verified by conducting a GMDSS Radio Survey by an authorized person representing a Classification Society (e.g. DNV-GL). The GMDSS Radio Survey must be completed by a person who has received technical training directly or indirectly and understand the capabilities and services of the LT-3100S GMDSS system. National flag authorities and their regulations for radio survey must be followed.

IMPORTANT: The LT-3100S GMDSS system operational status cannot be considered seaworthy, before an official GMDSS Radio Survey has been completed successfully, accordingly to the SOLAS IMO resolutions.

Test of Distress Alert, Distress Call, and MSI

The LT-3100S GMDSS system support test of Distress Alert, Distress Call, and MSI (in test mode). These tests are performed as part of the following LT-3100S GMDSS system wizards:

- Installation Wizard (see *Installation Wizard* on page 61)
- Service Wizard (see *Service Wizard* on page 76)
- GMDSS Test Wizard (see *Terminal Test* on page 127) - can be activated by the user at any time

In test mode, the LT-3100S GMDSS system is verifying the Distress functions towards the Iridium GMDSS System (IGS), indicating test mode and therefore the Rescue Coordination Centers (RCC) will not be involved.

NOTE: In test mode, when activating the DISTRESS button, the pop-up window color is green to indicate that the LT-3100S GMDSS system is in test mode and therefore the RCCs will not be involved.

Change of Hardware and Software

The LT-3100S GMDSS system will initially be configured, verified, and activated by guidance of the Installation Wizard, as described and illustrated in *Installation Wizard* on page 61. Hereafter, if system units are replaced or the LT-3100S GMDSS system is updated with new software, the Service Wizard will detect this and help the user with the configuration, verification, and re-activation. The Service Wizard is described and illustrated in *Service Wizard* on page 76.

Change of Hardware		
Hardware	Procedure	Comments
LT-3110S Control Unit	The LT-3110S CU can be replaced by swapping the hardware and running the Installation Wizard. Remember the GMDSS SIM card from the 'old' LT-3110S CU.	All user data (contacts, call history, SMS, and MSI) will be lost, since the LT-3110S CU is the 'master' of the system.
LT-3120 Handset	Change hardware.	Test the new hardware.
LT-3121 Cradle		
LT-3130 Antenna Unit	The LT-3130 AU can be replaced with a new LT-3130 AU, but the Iridium GMDSS Service Provider must be involved. The IMEI number of the new LT-3130 AU must be updated on the GMDSS provisioning before the new LT-3130 AU is connected to the LT-3110S CU and the system is powered up. The Service Wizard will detect the new LT-3130 AU and help the user with the configuration, verification, and re-activation on the Iridium GMDSS System (IGS). AU should show up in System -> System Info -> Unit Info	
LT-3140S Interface Unit	Remove DC input power and connect LT-3140S IU and peripherals. The units will automatically be detected and added. All units will be showed in the MENU layout (MENU -> System -> System Info -> Unit Info).	Activate the GMDSS Test Wizard 'Terminal Test' from the GMDSS submenu to test the added units.
LT-3150S Alarm Panel		
LT-3160S Printer Adapter		
GMDSS SIM Card	The GMDSS SIM card can be replaced with a new GMDSS SIM card, but the Iridium GMDSS Service Provider must be involved. The ICCID number of the new GMDSS SIM card must be updated on the GMDSS provisioning before the new GMDSS SIM card is inserted in the LT-3110S CU and the system is powered up. The Service Wizard will detect the new GMDSS SIM card and help the user with the configuration, verification, and re-activation on the Iridium GMDSS System (IGS).	Only a GMDSS SIM card can be used in the LT-3100S GMDSS system.

Table 28: Change of Hardware in the LT-3100S GMDSS system

Change of Hardware

This section will provide some guidance on replacing system units and what the user of the LT-3100S GMDSS system should be aware of, see Table 28.

Always remove the DC input power to the LT-3100S GMDSS system when changing the hardware and system units. When changes hardware the responsible technician shall always verify the installation using the GMDSS Test wizard found in: MENU -> GMDSS -> Terminal Test.

- NOTE:** Changing the LT-3130 Antenna Unit or the GMDSS SIM card requires involving of the Iridium GMDSS Service Provider (SP) and GMDSS provisioning. For details of the Iridium GMDSS Service Provider (SP), see *Activating the System* on page 58.
- NOTE:** If moving a LT-3100S GMDSS system from one vessel to another vessel, then make sure to change all vessel and safety contact details in the GMDSS provisioning, i.e. in the Iridium Maritime Safety Service Activation Form (MSSAF). The MSSAF form is described in *Maritime Safety Service Activation Form (MSSAF)* on page 59.
- NOTE:** It is currently not possible to remove units from the system by unplugging and power cycling. A factory reset is required, followed by re-running the Installation Wizard.
- NOTE:** Successfully adding LT-3150S Alarm Panel(s) will result in Alarm Panel buttons being backlit. Pressing the MUTE button results in a key beep.
- NOTE:** Addition of only the LT-3160S Printer Adapter cannot be verified by the user. A printer is required for verification.

Software update

The LT-3100S GMDSS system must be software updated by using the web server, configuration - software update, see *Software update* on page 202. Accessing the web server is described in *Accessing the built-in web server* on page 178. The software update procedure will automatically update all system units connected to the LT-3110S Control Unit. The Lars Thrane Image (LTI-file) e.g. LT-3100S-v1.04R-0010.lti will include all software components to all system units. All system units connected to the LT-3110S Control Unit will be upgraded or downgraded to be aligned with the LT-3110S Control Unit, which is the 'master' of the system. As soon as the software update procedure is started, the LT-3110S Control Unit window will indicate 'Software update in progress' as illustrated in Figure 96.

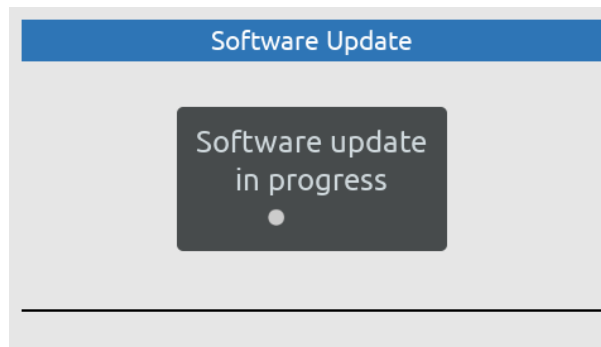

Figure 96: Software update

Once, the LT-3100S GMDSS system has finalized the software update, the system will reboot and startup showing the Service Wizard, as illustrated in Figure 97 on page 76. To finalize the software update, complete the Service Wizard.

NOTE: Please check the Lars Thrane A/S company website for newest available software for the LT-3100S GMDSS system.

Service Wizard

The Service Wizard is a guidance tool to help the user of the LT-3100S GMDSS system to help complete hardware changes or software updates. The Service Wizard is very similar to the Installation Wizard, which is described in *Installation Wizard* on page 61. The Service Wizard is activated as defined in Table 29.

Service Wizard		
System change	Activated	Comments
New software	Yes	
New LT-3130 AU	Yes	IMEI must be changed for the GMDSS provisioning.
New GMDSS SIM card	Yes	ICCID must be changed for the GMDSS provisioning.

Table 29: Service Wizard

NOTE: The difference between the Installation and Service Wizard is illustrated in Table 27 on page 61. The Service Wizard is activated when system changes are made to the LT-3100S GMDSS system, where it is needed to check for a new GMDSS configuration file and re-activate the system on the Iridium GMDSS System (IGS).

Figure 97 is illustrating the activation of the Service Wizard due to a software update of the LT-3100S GMDSS system. Press the soft key 'Next' to start the Service Wizard. Figure 98 is illustrating the last window for completing the Service Wizard. Additional steps are illustrated in *Installation Wizard* on page 61.

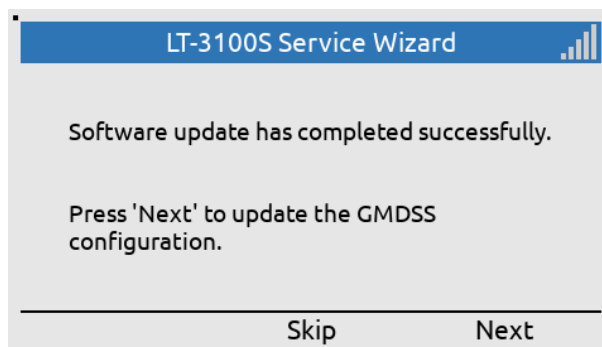

Figure 97: Service Wizard (software update)

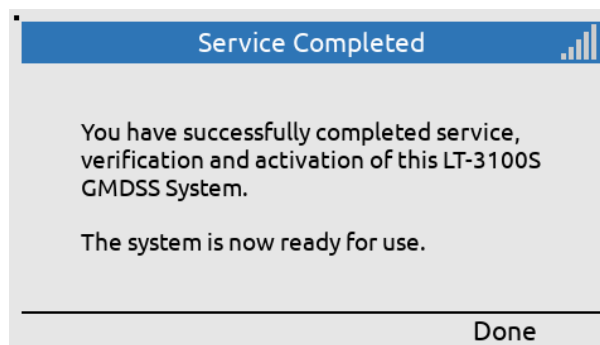

Figure 98: Service Wizard (completed)

GMDSS Services

The LT-3100S GMDSS system support both GMDSS services, as well as non-GMDSS services. The GMDSS services supported by the LT-3100S GMDSS system are listed here:

- Distress Alert & Distress Call
- Distress Alert Relay
- Maritime Safety Information (MSI)
- Safety Calling
- Safety Messaging

The above listed GMDSS services are all described in further detail in this section. The non-GMDSS services are described in *System Services* on page 133.

Service	Direction	Priority			
		Distress	Urgency	Safety	Routine
Distress Alert	MO	X	-	-	-
MSI (Incl. Distress Alert Relay)	MT	X	X	X	-
Safety Calling	MO, MT	X	X	X	-
Safety Messaging	MO, MT	X	X	X	-
General Calling (Voice Call)	MO, MT	-	-	-	X
General Messaging (SMS)	MO, MT	-	-	-	X

Table 30: LT-3100S GMDSS System Services and Priorities

IMPORTANT: A mobile originated (MO) Safety Call of Distress priority can only be initiated, if Distress is activated by using the DISTRESS button. This also applies to Safety Messaging.

The LT-3100S GMDSS and Non-GMDSS Services are listed in Table 30. For all the services, the supported priorities are shown (Distress, Urgency, Safety, and Routine). The LT-3100S GMDSS system support priority and preemption for Mobile Originated (MO) and Mobile Terminated (MT) services.

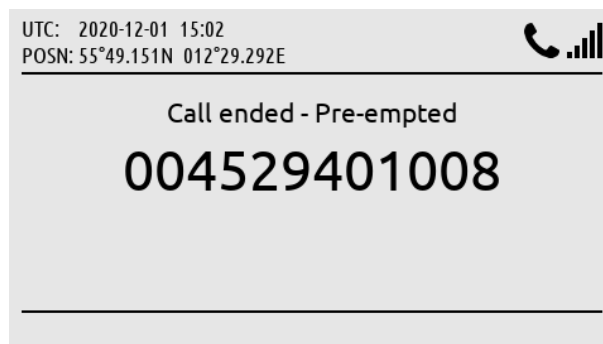

Figure 99: Voice Call (preempted)

If a service with higher priority is required, the service with lower priority will be preempted automatically by the LT-3100S GMDSS system or by the Iridium GMDSS System (IGS). An example of a voice call being preempted by the Iridium GMDSS System (IGS) is illustrated above in Figure 99.

Distress Alert & Distress Call

The Distress can be activated using the DISTRESS button on the LT-3110S Control Unit or from the DISTRESS button on the LT-3150S Alarm Panel. The LT-3150S Alarm Panel shall be connected via the LT-3140S Interface Unit, up to 3 external LT-3150S Alarm Panels can be connected to the system.

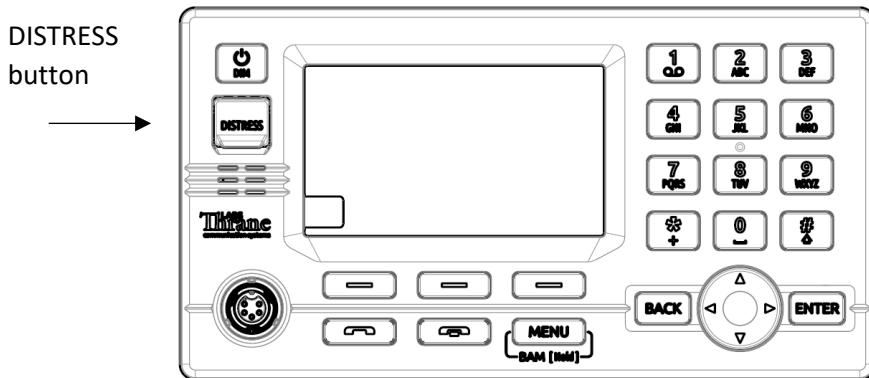

Figure 100: LT-3110S Control Unit (DISTRESS button)

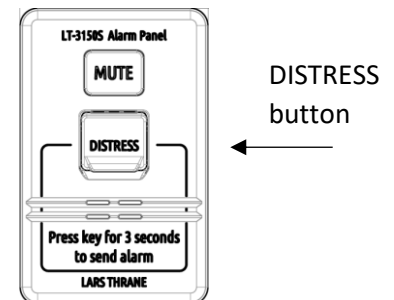

Figure 101: LT-3150S Alarm Panel (DISTRESS button)

The procedure for activating the Distress is the same for all DISTRESS buttons:

1. Lift the red lid marked DISTRESS
2. Press and hold the red DISTRESS button for a minimum 3 seconds (a distress tone will be played immediately when pushing the DISTRESS button)
3. The Distress will be activated in the LT-3100S GMDSS system after 3 seconds - indicated by distress tone stopping
4. Hereafter you can release the DISTRESS button (the light in the red button is now on maximum intensity)

IMPORTANT: After activating Distress from an external LT-3150S Alarm Panel, it is recommended to check the status of the Distress by verifying the display information on the LT-3110S Control Unit, where Distress delivery status will be presented (e.g. Distress Alert Status = Sending, Sent, Delivered, and Acknowledged).

The Distress will preempt any other service (voice or data), if needed.

IMPORTANT: By default, the LT-3100S GMDSS system is configured to complete a Distress Alert message followed by a Distress Call to a Rescue Coordination Center (RCC) after the DISTRESS button has been activated. A configuration of the LT-3100S GMDSS system is available, where the system will not automatically make the Distress Call to the RCC, when the DISTRESS button has been activated. If the LT-3100S GMDSS system has been configured not to automatically call the RCC, then this Distress Call can manually be initiated from a soft key after the Distress Alert has been delivered.

This section will illustrate and explain how to activate a Distress from the LT-3110S Control Unit. After the Distress has been activated (pushing the DISTRESS button for more than 3 seconds) status information will be available, i.e. providing Distress Alert Status delivery information.

The following Distress activities will be illustrated in this section:

- Activation of Distress (Distress Alert & Distress Call) - Distress Settings, Auto-dial = Enabled
- Select Nature of Distress
- Canceling Distress

IMPORTANT: It is possible to activate Distress from either the LT-3110S Control Unit or from the LT-3150S Alarm Panel (if any external LT-3150S Alarm Panels are part of the system configuration). The LT-3110S Control Unit is providing detailed information about the Distress Alert and Distress Call status and therefore it is recommended to check this unit after activation of Distress. Only from the LT-3110S Control Unit you will be able to get in contact with the Rescue Coordination Center (RCC) via the LT-3120 Handset.

Activation of Distress (Distress Alert & Distress Call)



LT-3110S Control Unit, default window.

Figure 102: Activating Distress (1 of 9)

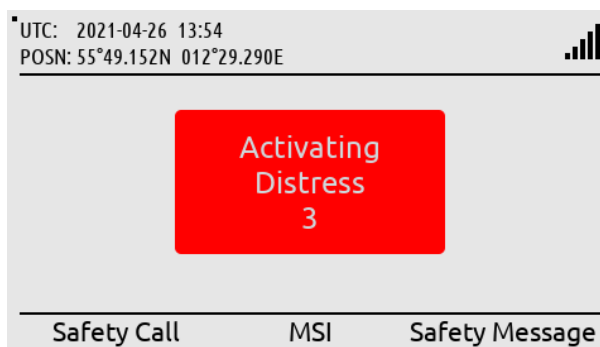

Activation of Distress: DISTRESS button must be held for a minimum of 3 seconds to activate a Distress.

Figure 103: Activating Distress (2 of 9)

NOTE: In this example a test RCC has been used to illustrate the Distress (East_TEST_RCC).



Distress Alert Status = Sending.

Figure 104: Activating Distress (3 of 9)



Distress Alert Status = Sent.

Figure 105: Activating Distress (4 of 9)



Distress Alert Status = Delivered (Iridium GMDSS System has received the Distress Alert message).

Figure 106: Activating Distress (5 of 9)

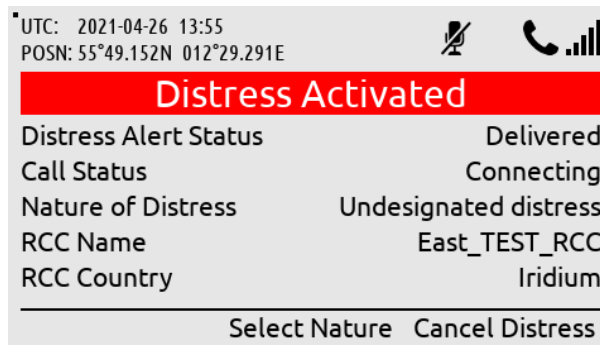

Call Status = Connecting (if Auto-dial = Enabled, then a Distress Call will automatically be established to a RCC).

Figure 107: Activating Distress (6 of 9)

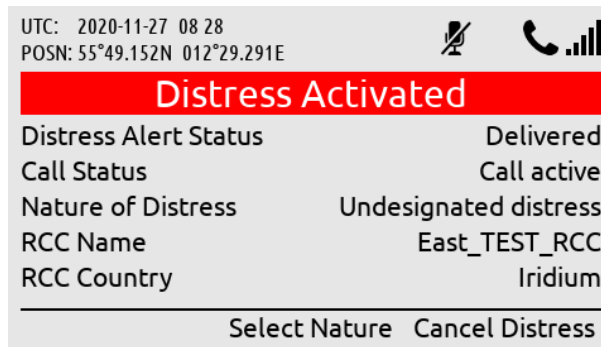

Call Status = Call active
(Distress Call has now been established to the RCC).

Figure 108: Activating Distress (7 of 9)

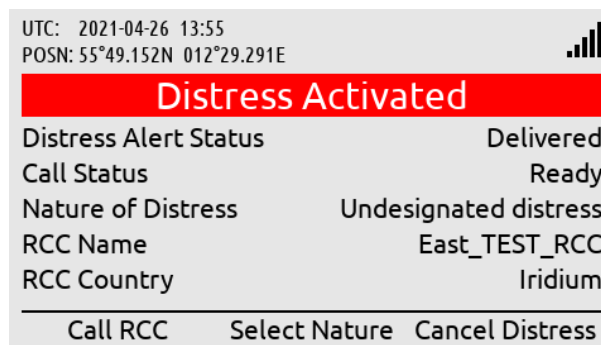

Call Status = Ready
(Distress Call has been disconnected to the RCC).
Use soft key 'Call RCC' to activate a new Distress Call.

Figure 109: Activating Distress (8 of 9)

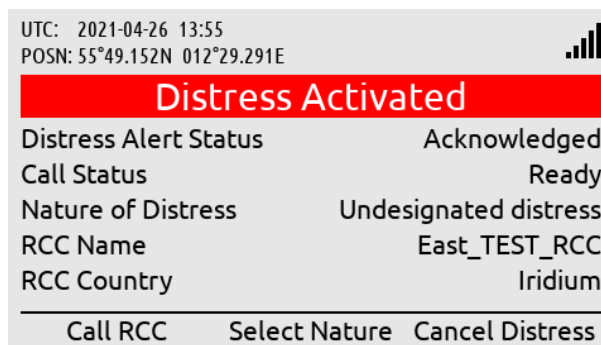

Distress Alert Status = Acknowledged
(Distress Alert message has manually been acknowledged by the RCC).

Figure 110: Activating Distress (9 of 9)

IMPORTANT: After the Distress Alert message has been acknowledged by the Iridium GMDSS System (IGS), the system will automatically make a Distress Call to the configured RCC, if the “auto-dial” setting is enabled.

A Distress Call can be established to the RCC any time after the Distress Alert message has been acknowledged by the Iridium GMDSS System (IGS). If the “auto-dial” setting is enabled, a Distress Call is automatically established after acknowledgement has been received (~Delivered). To manually activate a Distress Call, press the soft key ‘Call RCC’ and lift the handset out of the cradle when the call is connected.

Select Nature of Distress

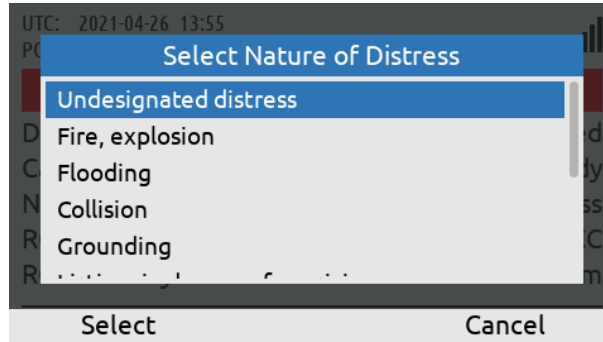

Use the soft key 'Select Nature' to send Nature of Distress information to the RCC.

Figure 111: Select Nature of Distress (1 of 4)

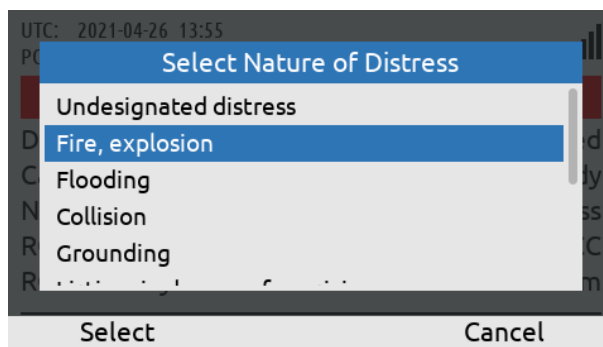

Use the Navigation key (arrow up/down) to select the Nature of Distress and select.

Figure 112: Select Nature of Distress (2 of 4)

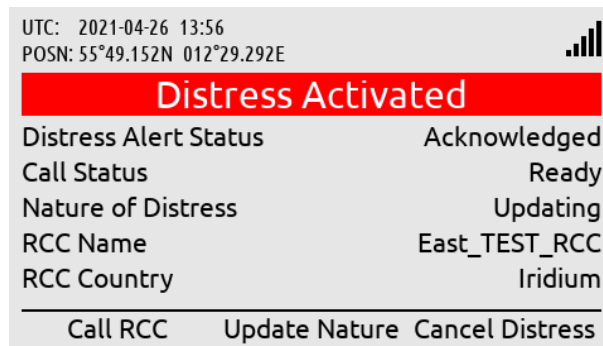

An updated Distress Alert message will now be sent to the RCC with the Nature of Distress information (e.g. Fire, explosion).

Figure 113: Select Nature of Distress (3 of 4)

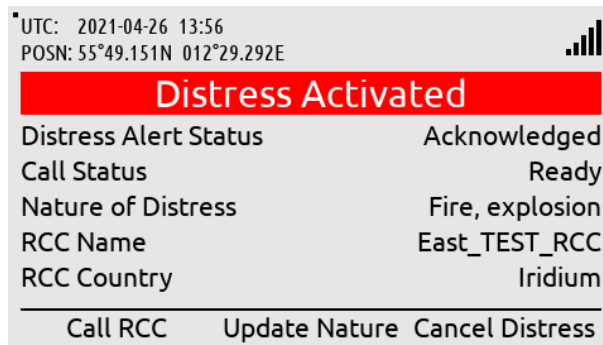

Updating will change to the selected Nature of Distress once the update has been received by the RCC.

Figure 114: Select Nature of Distress (4 of 4)

NOTE: The Nature of Distress can be selected before (MENU -> GMDSS -> Distress Settings: Nature of Distress) or after (soft key 'Select Nature' or 'Update Nature') activation of the Distress.

Cancelling Distress

To cancel a Distress, press the soft key 'Cancel Distress' and confirm the decision. The LT-3100S GMDSS system will notify the RCC that the Distress has been cancelled.

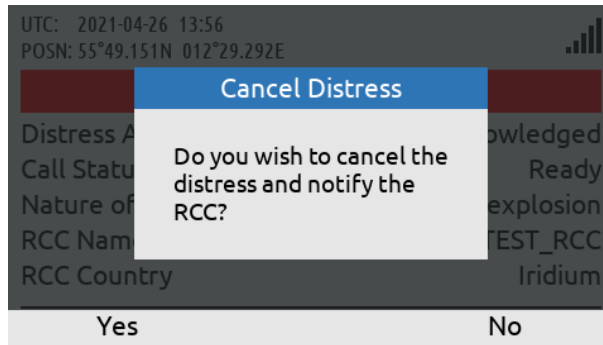

To cancel a Distress, use the soft key 'Cancel Distress' and confirm.

Figure 115: Cancelling Distress (1 of 3)



A Distress Alert message indicating Cancelled will be sent to the Iridium GMDSS System (IGS) and the RCC.

Figure 116: Cancelling Distress (2 of 3)



The LT-3100S GMDSS system will now be back to the default window and operation.

Figure 117: Cancelling Distress (3 of 3)

Distress Alert Relay

This section is illustrating the LT-3100S GMDSS system behavior when a Distress Alert Relay message is received from a Rescue Coordination Center (RCC). A Distress Alert Relay message is sent by an RCC to a predefined area (e.g. a circular area of radius 50 NM) when another vessel nearby has sent a Distress Alert message and assistance is required. The Distress Alert Relay message will contain information from the vessel in Distress. The Distress Alert Relay message will be available in the MSI (inbox). By pushing the soft key 'MSI(X)' the operator of the system will be directed to the MSI (inbox) for reading the incoming message. The following figures, Figure 118 to Figure 124, are illustrating the reception of a Distress Alert Relay message, sent from an RCC.

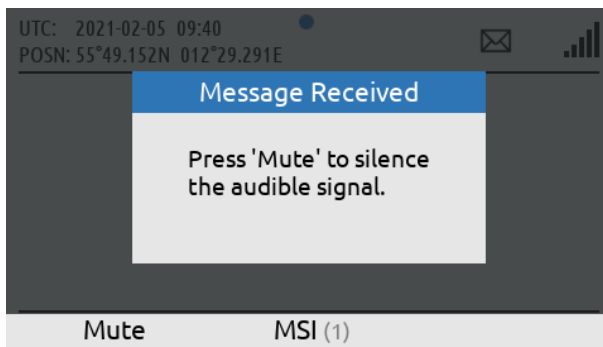

The LT-3100S GMDSS System has received a new MSI message with priority of Urgency or Distress. The audible alarm can be muted by pressing 'Mute'

Figure 118: Distress Alert Relay (1 of 7)

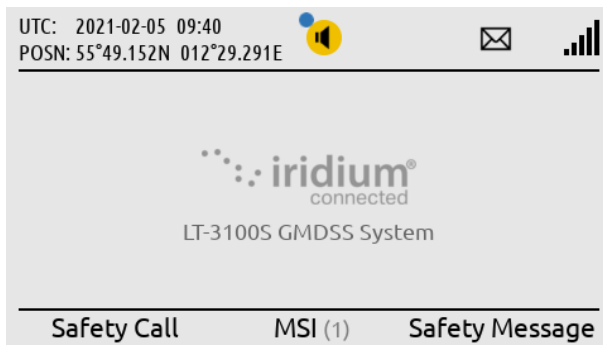

By pressing 'Mute' the system returns to the default screen. The BAM alert symbol and MSI(1) indicates that the priority message has not yet been read .

Figure 119: Distress Alert Relay (2 of 7)

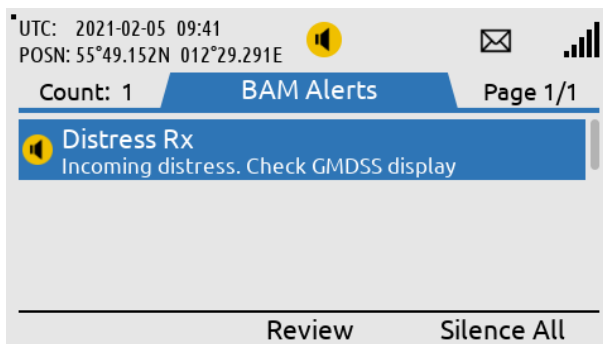

Long press on the MENU button, will direct the user to the BAM alerts list. If not already muted, the BAM alert can be muted by pressing the soft key 'Silence All'. Additional BAM alerts with audible alarms require another press of 'Silence All'

Figure 120: Distress Alert Relay (3 of 7)

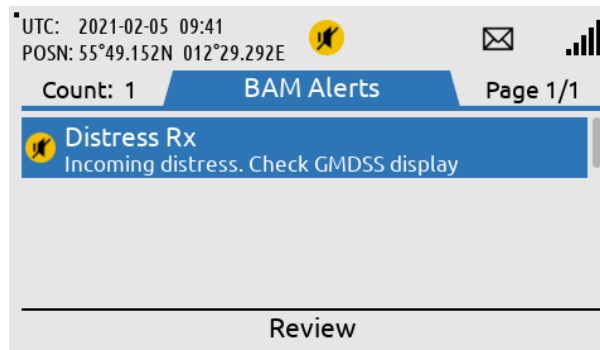

Figure 121: Distress Alert Relay (4 of 7)

Pressing the soft key 'Review' will direct the user to the specific MSI or Safety Message responsible for the BAM Alert. This can also be done from the default screen.



Figure 122: Distress Alert Relay (5 of 7)

To go back to the default window press the 'Menu' button. By pressing the soft key 'MSI (1)' the user will be directed to the MSI window (1 unread MSI message).

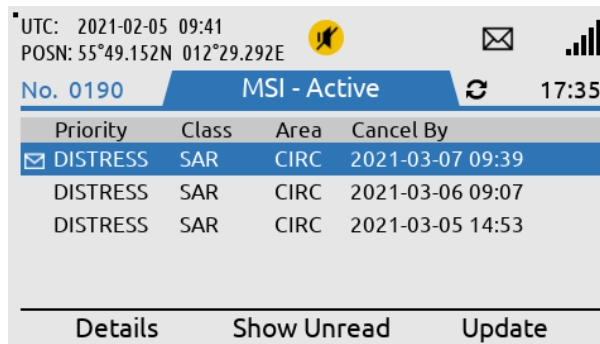

Figure 123: Distress Alert Relay (6 of 7)

The MSI message is a Distress Alert Relay message, Class SAR (Search and Rescue). The MSI message can be read by pressing the soft key 'Details'.

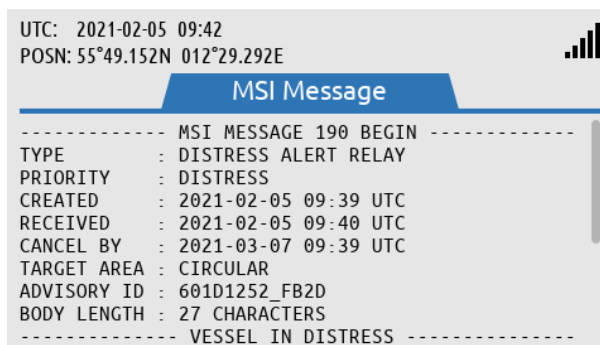

Figure 124: Distress Alert Relay (7 of 7)

The Distress Alert Relay message has some attribute information listed in the beginning. Use the Navigation key to scroll down and read the body of the message.

The LT-3100S GMDSS system will generate visual and audio notifications, when a Distress Alert Relay message is received. The Distress Relay message will generate a BAM warning, which can be viewed by long press the MENU button for more > 1 s. As illustrated in Figure 120 and Figure 121, the BAM warning can be muted either via the soft key 'Mute' or via the soft key 'Silence All'. By pressing the soft key 'Review', you will be directed to the MSI Messages. The BAM warning cannot be acknowledged, and the visual and audio notification will only disappear, when the Distress Alert Relay message has been read in the MSI Messages.

A Distress Alert Relay message received by the LT-3100S GMDSS system is illustrated in Figure 125.

```

----- MSI MESSAGE 53 BEGIN -----
TYPE           : DISTRESS ALERT RELAY
PRIORITY       : DISTRESS
CREATED        : 2020-11-27 09:52 UTC
RECEIVED       : 2020-11-27 09:52 UTC
CANCEL BY     : 2020-12-27 09:52 UTC
TARGET AREA   : CIRCULAR
ADVISORY ID    : 5FCOCC3B_643F
BODY LENGTH   : 443 Characters
-----VESSEL IN DISTRESS-----
DISTRESS      : ACTIVE
POSN         : 55-45.634N 012-36.213E
TIME OF POSN  : 2020-11-27 09:49 UTC
MMSI        : 219022390
NAME         : ARIZONA
-----MESSAGE BODY-----
DISTRESS ALERT: IRIDIUM
DISTRESS MESSAGE RECEIVED VIA IRIDIUM
VESSEL MMSI: 219022390
VESSEL NAME: Arizona
SES: SES1
DEVICE MSISDN: 881641700113
DISTRESS TYPE: undesignated distress
MESSAGE DATE: 2020-11-27
MESSAGE TIME: 09:49 UTC
MESSAGE TYPE: NEW
LATITUDE: 55.76057N
LONGITUDE: 12.60355E
POSITION RECORDED: 2020-11-27 09:49 UTC
POSITION TYPE: AUTOMATIC
POSITION UPDATED LAST 24 HRS: YES
HEADING: 12
SPEED: 0.0 KTS
RECEIVING GATEWAY: ARIZONA
<Optional text inserted by the RCC>
----- MSI MESSAGE 53 END -----

```

Figure 125: Distress Alert Relay (example)

IMPORTANT: A Distress Alert Relay message contains vital information about the vessel in Distress: Name, MMSI, Position, Nature of Distress, and MSISDN (if the Distress Alert message is initiated from an Iridium terminal). An example of a Distress Alert Relay message is illustrated in Figure 125. If your vessel is not being contacted directly by an RCC, after you have received a Distress Alert Relay message, then get back to the RCC and offer your assistance.

Maritime Safety Information (MSI)

Maritime Safety Information (MSI) is information sent by different maritime authorities to radio and satellite equipment on-board SOLAS vessels. The information can vary from weather forecast, navigation relevant information, reception of Distress Alert Relay, to SAR coordination information. The different maritime authorities providing the MSI messages are listed here:

- NAVAREA Coordinator (MSI Provider)
- METAREA Coordinator (MSI Provider)
- Rescue Coordination Center (SAR)

and further details describing the different MSI messages are showed in Table 31.

Maritime Safety Information (MSI) Supported by the IGS				
Message Type	Class	Authority	Geography	Priority
Navigational warning or bulletin	NAV	MSI Provider	Rectangular Circular NAVAREA COASTAL	Safety Urgency
Meteorological warning or forecast	MET	MSI Provider	Rectangular Circular METAREA COASTAL	Safety Urgency
Urgency & Safety Traffic	NAV SAR	MSI Provider RCC	NAVAREA	Safety Urgency
Shore to Ship Distress Alert Relay	SAR	RCC	Rectangular Circular	Distress
SAR Coordination Traffic	SAR	RCC	Rectangular Circular	Safety Urgency Distress
Piracy Situation Report	NAV (Piracy)	MSI Provider	Rectangular Circular NAVAREA COASTAL	Safety
Piracy Attack Warning	NAV (Piracy)	MSI Provider	Rectangular Circular NAVAREA COASTAL	Urgency

Table 31: Maritime Safety Information (MSI) supported by the Iridium GMDSS System (IGS)

NOTE: MSI message can be sent with the priorities: Distress, Urgency, or Safety. MSI message with priority: Distress, will be scheduled with immediately delivery. MSI message with priority: Urgency, will be scheduled with immediate or scheduled delivery. MSI message with priority: Safety, will be scheduled with scheduled delivery. Scheduled delivery is configured between two and four times a day, depending on the NAVAREA / METAREA. The scheduled delivery time is available in the MSI schedule and illustrated in Figure 127 on page 89.

The LT-3100S GMDSS system will always receive MSI messages from the current NAVAREA / METAREA and Coastal Warning Area, in which the LT-3100S GMDSS system is located. It is possible to configure the system, e.g. to receive MSI messages from other NAVAREA / METAREA and Coastal Warning Areas. MSI Settings are described in *MSI Settings* on page 107.

The figures, Figure 126 to Figure 129, illustrates how to read an MSI message. In this example the MSI message is a Navigational warning or forecast, sent from NAVAREA 1 (United Kingdom) with priority: Safety. The MSI message has been sent with scheduled delivery and received by the LT-3100S GMDSS system 2020-11-30 09:53 (UTC), see Figure 128 on page 90.



The LT-3100S GMDSS system default window. When unread MSI messages are available, the soft key 'MSI' will change to 'MSI (X)', where X is the number of unread messages.

Figure 126: MSI Message (1 of 4)

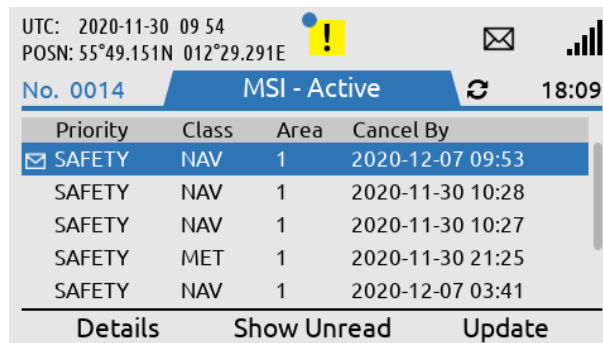

The MSI window will show Priority, Class, Area, and time of cancellation for the MSI messages. Read the MSI message by pressing soft 'Details'.

Figure 127: MSI Message (2 of 4)

NOTE: If there are any unread MSI messages available in the LT-3100S GMDSS system, then soft key 'MSI' will be changed to 'MSI(X)', where X is the number of unread MSI messages. Depending on the priority of the unread MSI messages available, BAM will generate an active caution or active - unacknowledged warning. By pressing the 'MSI' softkey the user will enter the MSI list, where the MSI Messages are listed in order of reception. When receiving multiple MSI messages of Safety priority, the terminal will only emit one audible notification.

IMPORTANT: All MSI messages received by the LT-3100S GMDSS system must be read as soon as practically possible. It is not acceptable to have unread MSI messages available in the system.

MSI messages can contain up to 15 KB. Figure 128 illustrates that the size of this Navigational MSI message is of 2202 Bytes. Standard characters use 1 Byte, where special characters uses > 1 Byte.

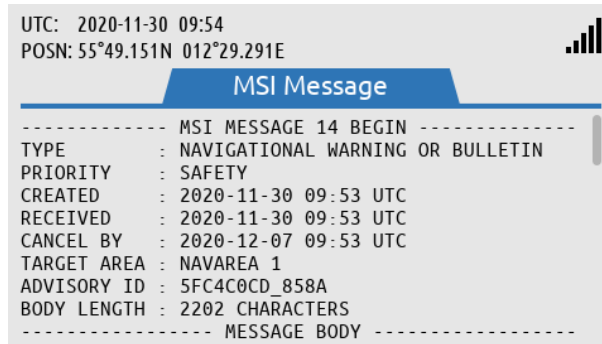

The MSI message has some attribute information listed in the beginning. Use the Navigation key to scroll down and read the body of message.

Figure 128: MSI Message (3 of 4)

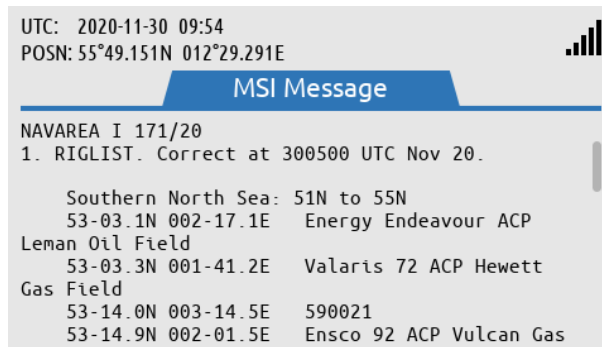

Body of the MSI message. Scroll down to read the entire MSI message.

Figure 129: MSI Message (4 of 4)

If the MSI message obtains more space than a window, then a scroll bar will be available in the right side of the MSI message window, as shown on the figures above.

NOTE: It is also possible to read MSI messages via the Web Server. See *Authentication* on page 183.

Mute of MSI messages

A dialog box is shown in the display upon reception of an MSI message with priority Urgency or Distress, this is illustrated in Figure 130. Upon pressing the soft key 'Mute', the accompanying loud and continuous audible signal is muted.

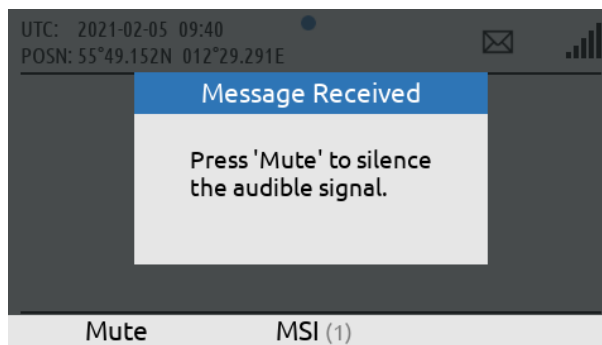

Figure 130: MSI Message (illustration of 'Mute')

Coastal Warning / Subject Indicators

MSI messages (type: Coastal Warnings), will be related to a specific Coastal Warning Area (A - Z), e.g. 10-A, where A is the Coastal Warning Area, belonging to NAVAREA 10. One or more Coastal Warning Areas can be configured in the MSI Settings, Coastal Warning Areas. The Coastal Warnings will provide information, which is subcategories in Subject Indicators (SI). The Subject Indicators are listed in Table 32. The configuration of the Subject Indicators is described in *MSI Settings* starting on page 107, under Coastal Warning Services. The Subject Indicators are also referred as Coastal Warning Services. Be aware, that some of the Subject Indicators can be configured, others are mandatory.

SI	Description	SI	Description
A	Navigational warnings	H	LORAN messages
B	Meteorological warnings	I	Not used
C	Ice Reports	J	SATNAV messages
D	Search and rescue information, and acts of piracy warnings	K	Other electronic navaid messages
E	Meteorological forecast	L	Other navigational warnings
F	Pilot service messages	V, W, X, Y	Special service allocation by the International SafetyNET panel
G	AIS	Z	No messages on hand

Table 32: MSI Messages (coastal warning / subject indicators (SI))

NOTE: By default, the LT-3100S GMDSS system will only receive Coastal Warnings from the Coastal Warning Area, in which the system is located, and only mandatory Subject Indicators are received. If the user of the LT-3100S GMDSS system would like to receive Coastal Warnings from additional Coastal Warning Areas, including non-mandatory Subject Indicators, then configuration in MSI Settings is required.

Safety Calling

Safety Calling is a GMDSS voice service supported between the LT-3100S GMDSS system and the Rescue Coordination Center (RCC). Safety Calling is not supported between two LT-3100S GMDSS systems. Safety Calling can be originated in both directions: 1) Mobile Originated (to RCC) and 2) Mobile Terminated (from RCC). Safety Calling is supported with priority: Distress, Urgency, and Safety.

IMPORTANT: Safety Calling (priority: Distress, also mentioned as Distress Call) can only be activated, if Distress has been activated by using the DISTRESS button. The section will focus on Safety Calling (priority: Urgency or Safety). Distress Call is described in *Distress Alert & Distress Call* on page 78.

Mobile Originated (to RCC)

A Safety Call to an RCC can be activated in two ways:

- 1) Using soft key ‘Safety Call’ (available on the default window)
- 2) Navigate to the RCC Contacts (MENU -> GMDSS -> Safety Contacts)

NOTE: It is possible to make a Safety Call to all RCCs supported by Iridium. Using the soft key ‘Safety Call’ on the default window, will initiate a Safety Call to the RCC configured in Distress Settings, Distress RCC. If the user of the LT-3100S GMDSS system navigates to MENU -> GMDSS -> Safety Contacts, then all RCCs supported by Iridium can be chosen. Safety Contacts is described in *Safety Contacts* on page 103.

The following figures, Figure 131 to Figure 134, illustrates how the user of the LT-3100S GMDSS system initiates a Safety Call (priority: Urgency) to an RCC configured in Distress Settings, Distress RCC (Automatic or Manual mode).

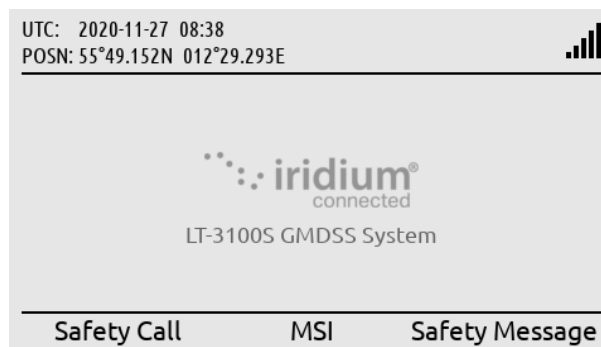

LT-3110S Control Unit, default window. A Safety Call can be initiated by using the soft key ‘Safety Call’.

Figure 131: Safety Call to RCC (1 of 4)

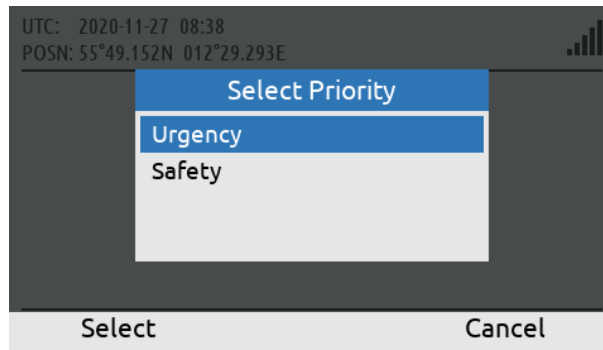

Select priority: Urgency or Safety by using the Navigation key (arrows). Hereafter use the soft key 'Select'.

Figure 132: Safety Call to RCC (2 of 4)

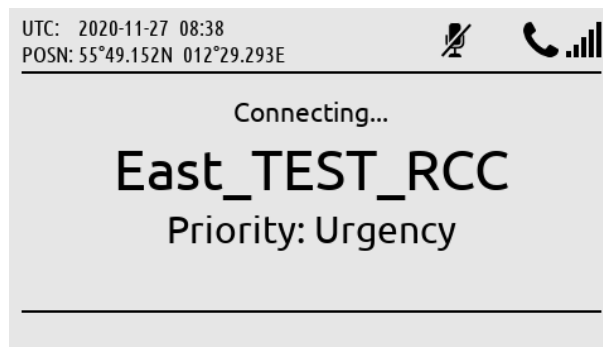

The Safety Call is connecting to the RCC (in this example East_TEST_RCC).

Figure 133: Safety Call to RCC (3 of 4)

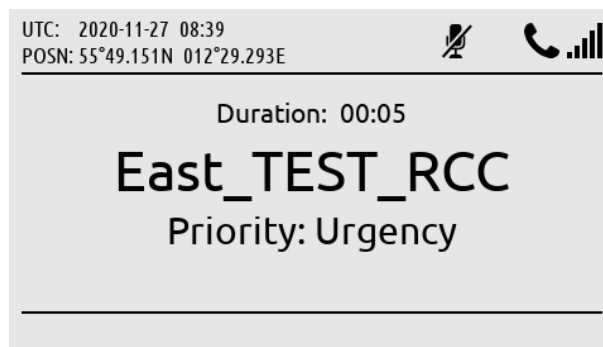

The Safety Call is connected (duration counter will start to count when the RCC has been connected).

Figure 134: Safety Call to RCC (4 of 4)

During a Safety Call, the RCC name and the priority of the call, are both presented in the call window. As soon as the Safety Call is connected to the RCC, the duration counter will start to count in the call window. The handset must be off hooked to unmute the handset microphone. In Figure 134 above, the handset microphone mute symbol is illustrated, since the handset is placed in the cradle (on hooked).

NOTE: A Safety Call will always show the RCC name and priority in the call window. In Figure 134 above, the user of the LT-3100S GMDSS system has initiated a Safety Call to RCC East_TEST_RCC (priority: Urgency). The Safety Call has been established to the RCC (duration counter has started).

Mobile Terminated (from RCC)

A Safety Call from an RCC can be received with priority: Distress, Urgency, or Safety. The incoming Safety Call will show the RCC name and priority. The following figures, Figure 135 to Figure 136, illustrates the reception of an mobile terminated Safety Call from RCC (East_TEST_RCC), with priority: Urgency. The Safety Call can be connected by lifting the handset out of the cradle or by pressing the off-hook button on the front of the control unit.

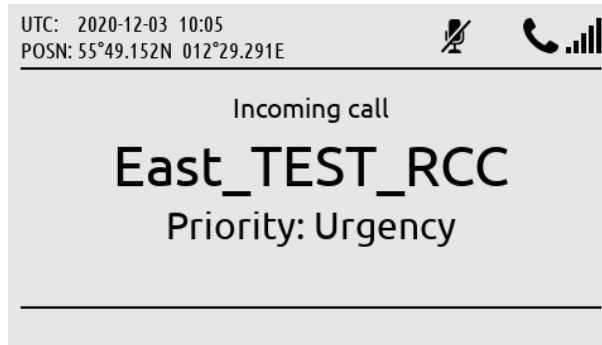

An incoming Safety Call (priority: Urgency) is calling the system. The RCC name will be displayed.

Figure 135: Safety Call from RCC (1 of 2)

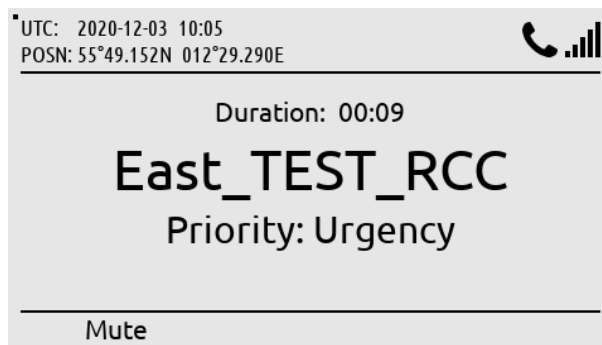

The Safety Call has been answered by lifting the handset out of the cradle.

Figure 136: Safety Call from RCC (2 of 2)

NOTE: When receiving a Safety Voice call from an RCC, the priority of the incoming call is shown in the call window together with the name of the RCC. In the example above, East_TEST_RCC has been used as a test RCC for illustration.

Two-digit Codes

The LT-3100S GMDSS system support two-digit codes, which is handled as Safety Calling (priority = Safety). The two-digit codes with supported service by the Iridium GMDSS System (IGS) are listed in Table 33.

Two-digit Codes		
Service	Short code	Comments
Medical Advice	32	
Medical Assistance	38	
Maritime Assistance	39	
Shipment of Meteorological Data	41	Not supported by the Iridium GMDSS System (IGS).
Report Maritime Dangers	42	
Ship Report Definitions	43	Not supported by the Iridium GMDSS System (IGS).

Table 33: Two-digit Codes

The Two-digit Codes can be entered directly in the default window. Alternatively, the user can access the Safety Contacts, and select the soft key ‘Show Next’, where a complete list of Two-digit Codes supported by Iridium are listed (MENU -> GMDSS -> Safety Contacts). Figure 137 to Figure 140 illustrates the initiation of ‘Medical Advice (32)’.

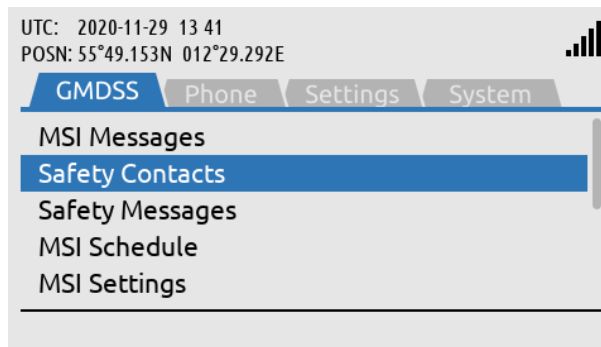

GMDSS submenu:
Safety Contacts

Figure 137: Two-digit Codes (1 of 4)

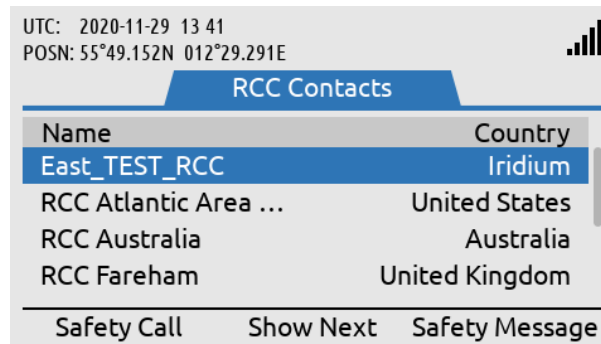

Press soft key ‘Show Next’ to access the Two-digit codes.

Figure 138: Two-digit Codes (2 of 4)

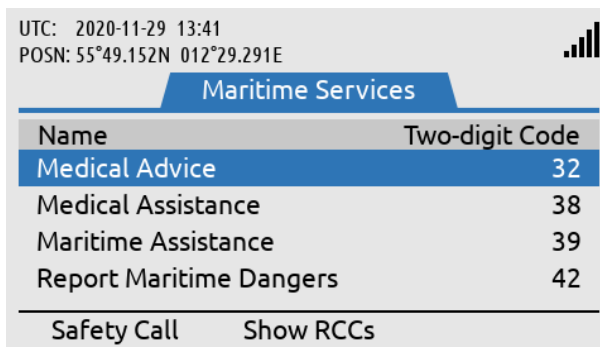

Select the Two-digit code (Maritime Service) and use the soft key 'Safety Call' to initiate the call.

Figure 139: Two-digit Codes (3 of 4)

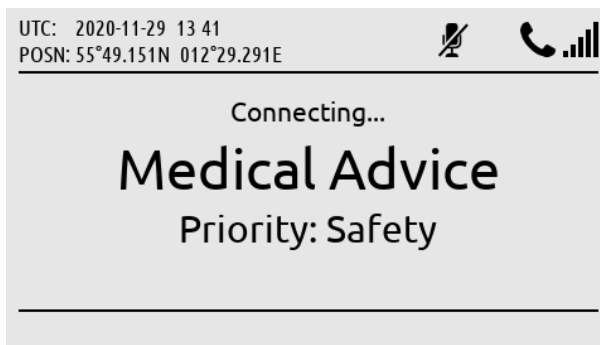

Safety Call (Medical Advice, Two-digit code: 32) being established.

Figure 140: Two-digit Codes (4 of 4)

NOTE: Use the LT-3110S Control Unit off-hook button or the soft key 'Safety Call' when the Two-digit Code has been selected as illustrated in Figure 139.

Safety Messaging

Safety Messaging is a GMDSS message service supported between the LT-3100S GMDSS system and the Rescue Coordination Center (RCC). Safety Messaging is not supported between two LT-3100S GMDSS systems. Safety Messaging can be originated in both directions: 1) Mobile Originated (to RCC) and 2) Mobile Terminated (from RCC). Safety Messaging is supported with priority: Distress, Urgency, and Safety.

Mobile Originated (sending to RCC)

A Safety Message to RCC can be initiated in three ways:

- 1) Using soft key 'Safety Message' (available on the default window)
- 2) Navigate to Safety Contacts (MENU -> GMDSS -> Safety Contacts)
- 3) Navigate to Safety Messages (MENU -> GMDSS -> Safety Messages)

NOTE: It is possible to send a Safety Message to all RCCs supported by Iridium. Using the soft key 'Safety Message' on the default window will initiate a Safety Message to the RCC configured in Distress Settings, Distress RCC. If the user of the LT-3100S GMDSS system navigates to MENU -> GMDSS -> Safety Contacts, then all RCCs supported by Iridium can be selected. Safety Contacts is described in *Safety Contacts* on page 103.

The figures, Figure 141 to Figure 146, illustrates how the user of the LT-3100S GMDSS system initiates a Safety Message (priority: Urgency) to an RCC configured in Distress Settings, Distress RCC (Automatic or Manual mode).



LT-3110S Control Unit, default window. A Safety Message can be initiated by pressing the soft key 'Safety Message'.

Figure 141: Safety Message to RCC (1 of 6)

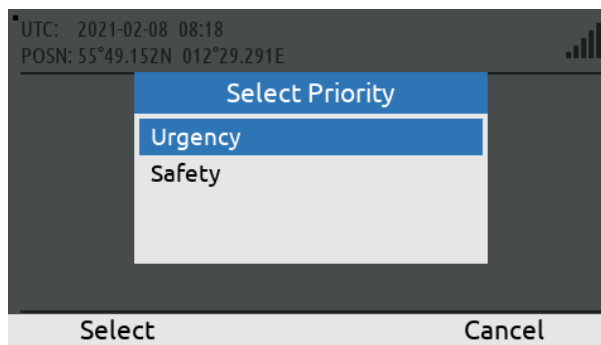

Select priority: Urgency or Safety.

Figure 142: Safety Message to RCC (2 of 6)

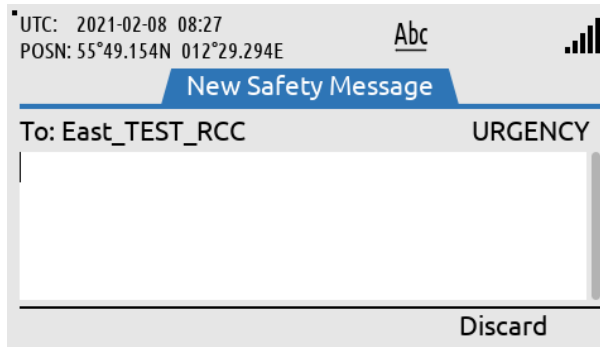

Write the body text of the Safety Message.

Figure 143: Safety Message to RCC (3 of 6)

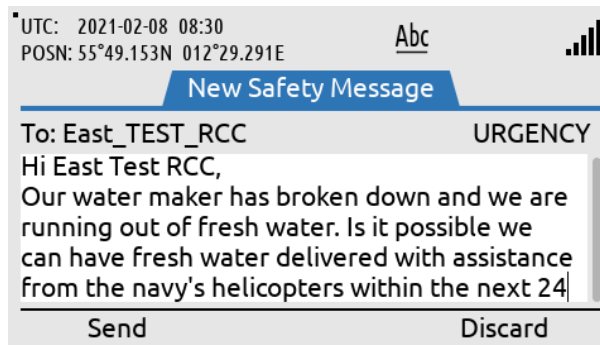

When the body text of the Safety Messages has been completed, then select soft key 'Send' and the Safety Message will be sent.

Figure 144: Safety Message to RCC (4 of 6)

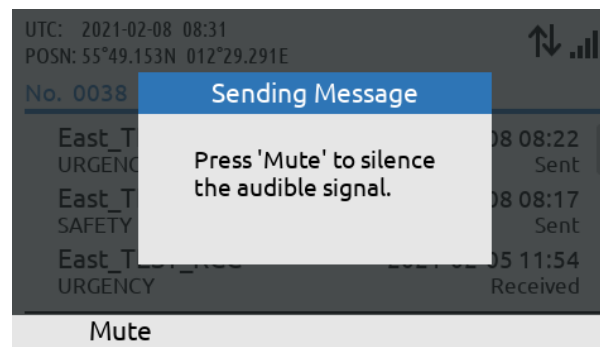

Sending a Safety Message of Urgency priority generates an audible alert. Press the soft key 'Mute' to mute the audible alert

Figure 145: Safety Message to RCC (5 of 6)



The sending status of the Safety Messages will change from: Sending to Sent (re-try will be possible, if needed).

Figure 146: Safety Message to RCC (6 of 6)

After the safety Message has been written the soft key 'Send' must be applied. The User of the LT-3100S GMDSS system will now see a window with all Safety Messages, with status information about the current transmission state: Sending, Sent or Failed. In Figure 146 on page 98 the Safety Message status is showing 'Sending', which means that the Safety Message has not been sent yet. As soon as the safety message has been sent from the LT-3100S GMDSS system, the status will change to from 'Sending' to 'Sent'. An audible signal is only generated while sending Safety Messages of priority: Urgency or Distress. Distress priority can only be used while a Distress is active.

NOTE: All Safety Messages received in the LT-3100S GMDSS system will be available in the Safety Messages (MENU -> GMDSS -> Safety Messages). It is possible to send Safety Messages up to 1000 characters.

Mobile Terminated (received from RCC)

A Safety Message from an RCC can be received with priority: Distress, Urgency, or Safety. An incoming Safety Message will be shown with the soft key Safety 'Msgs (1)' and with a BAM symbol in the status bar. A Safety Message with priority: Safety, will be indicated with the BAM active caution symbol, and Safety Messages with priority: Urgency or Distress will be indicated with the BAM active warning symbol. The figures, Figure 147 to Figure 152, illustrates the reception of an incoming Safety Message from East_TEST_RCC (priority: Urgency).

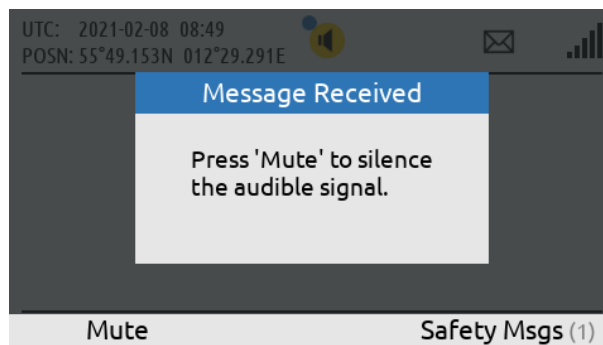

Receiving a Safety Message of Urgency or Distress priority generates an audible alert. Press the soft key 'Mute' to mute the audible alert

Figure 147: Safety Message from RCC (1 of 6)



Upon muting, the LT-3110S Control Unit returns to the default window. The Safety Message can be read by using the soft key 'Safety Msgs (1)'.

Figure 148: Safety Message from RCC (2 of 6)

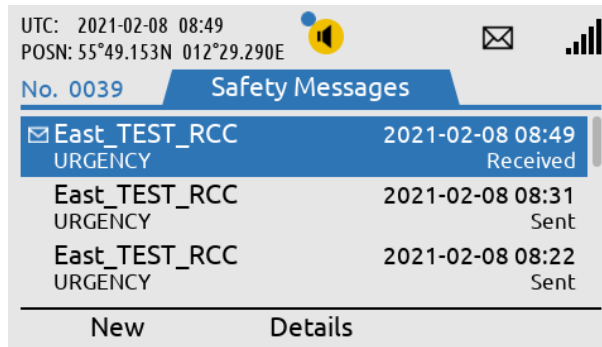

Read the Safety Message by pressing the ENTER button or use the soft key 'Details'.

Figure 149: Safety Message from RCC (3 of 6)

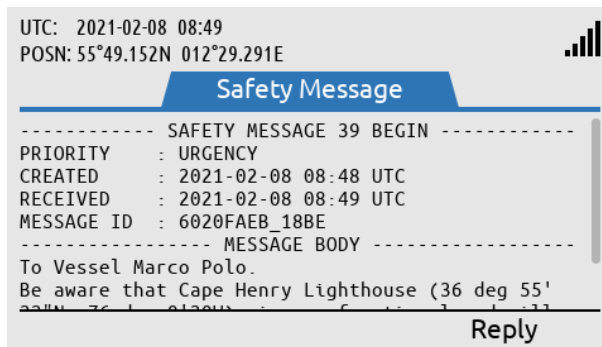

Use the Navigation key (arrow up/down) to read the entire Safety Message.

Figure 150: Safety Message from RCC (4 of 6)

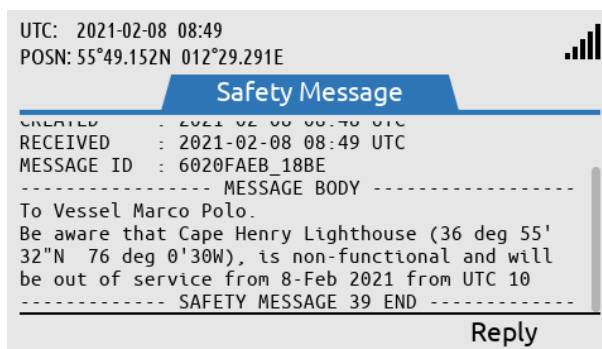

The Safety Message is now opened. The Safety Message contains a header and a message body.

Figure 151: Safety Message from RCC (5 of 6)



After the Safety Message has been opened (and read) the unread symbol and BAM alert will be removed.

Figure 152: Safety Message from RCC (6 of 6)

NOTE: All Safety Messages received in the LT-3100S GMDSS system will be available in the Safety Messages (MENU -> GMDSS -> Safety Messages). It is possible to receive Safety Messages consisting of up to 1000 characters (equivalent to 1000 letters)

GMDSS Submenu

This section will describe all relevant GMDSS settings and configurations. Some of the GMDSS submenus will only contain information/status about the LT-3100S GMDSS system.

The GMDSS submenu has the following menu path: MENU -> GMDSS

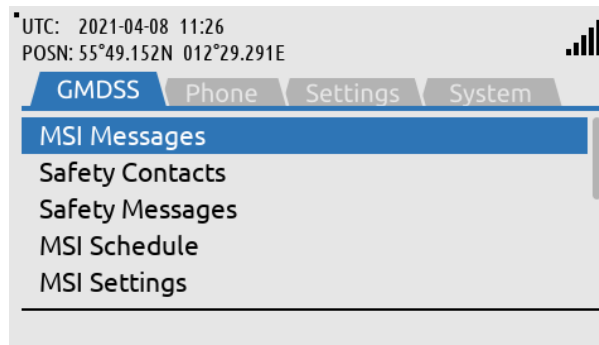

GMDSS submenu:
MENU -> GMDSS

Figure 153: GMDSS submenu

The GMDSS submenu has the following entries:

- MSI Messages (see *Maritime Safety Information (MSI)* on page 88)
- Safety Contacts
- Safety Messages (see *Safety Messaging* on page 97)
- MSI Schedule
- Distress Settings
- Position Settings
- Printer Settings
- Location Information
- SES Information
- Terminal Test

MSI and Safety Messages are both described in the previous section *GMDSS Services*, and therefore not further described here.

NOTE: The GMDSS submenu contains all relevant GMDSS information and configuration settings and provides access to all GMDSS Safety Service functions. Safety Call, MSI, and Safety Message will be available via soft keys from the LT-3110S Control Unit default window.

NOTE: The Printer Settings submenu is only present if a printer adapter is installed.

Safety Contacts

The Safety Contacts contains a list of all RCCs currently supported the Iridium GMDSS System (IGS). The Safety Contacts has the following menu path: MENU -> GMDSS -> Safety Contacts (~RCC Contacts)

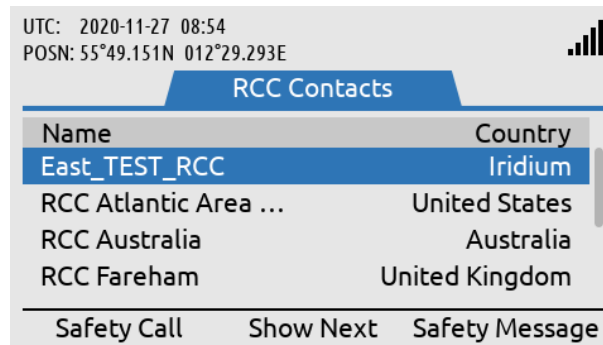

Safety Contacts
MENU -> GMDSS -> Safety
Contacts (~RCC Contacts)

Figure 154: GMDSS submenu (Safety Contacts)

Each of the RCC Contacts (RCCs) available in the list can be contacted via a Safety Call or a Safety Message. When entering the RCC Contacts, all RCCs can be contacted with the following priority: Safety or Urgency (the East_TEST_RCC will not be present on a production system).

NOTE: If the user of the LT-3100S GMDSS system would like to get in contact with an RCC that is different from the RCC configured in Distress Settings, Distress RCC (Automatic or Manual mode), then the user of the system must navigate to the RCC Contacts window. E.g. if the LT-3100S GMDSS system is configured to Distress RCC (Automatic mode) and the operator of the system would like to make a Safety Call to an RCC in a different Sea Area. Otherwise, the soft keys ‘Safety Call’ or ‘Safety Message’ on the default window of the LT-3110S Control Unit can be used.

Safety Call is described in further details in *Safety Calling* on page 92. Safety Messaging is described in further details in *Safety Messaging* on page 97.

IMPORTANT: The number of RCC supported in the Iridium GMDSS System (IGS) and available in the LT-3100S GMDSS system (RCC Contacts) will increase over time. Each and all Sea Areas will always have a responsible RCC covering a specific Sea Area. A new GMDSS configuration file will automatically and occasionally be pushed to the LT-3100S GMDSS system containing an up to date RCC list. The number of RCCs supported in the Iridium GMDSS System (IGS) is listed on the Iridium GMDSS website: <https://www.iridium.com/gmdss-launch/>

MSI Schedule

The LT-3100S GMDSS system support reception of MSI messages. The Maritime Safety Information (MSI) is described in *Maritime Safety Information (MSI)* on page 88. The MSI Schedule is providing an overview to the user about MSI messages: 1) from which NAV-/METAREAs and Coastal Warning Areas (CWA) the LT-3100S GMDSS system is receiving MSI messages from (default and optionally configured) and 2) at what time these MSI messages should be expected. MSI messages with high priority will typically be sent to the LT-3100S GMDSS system with no delay. The MSI Schedule is placed in the GMDSS submenu (MENU -> GMDSS -> MSI Schedule), see Figure 155 and Figure 156.

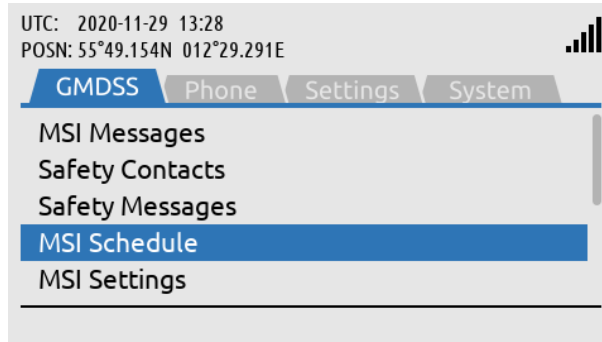

MSI Schedule:
MENU -> GMDSS -> MSI Schedule

Figure 155: GMDSS submenu (MSI Schedule)

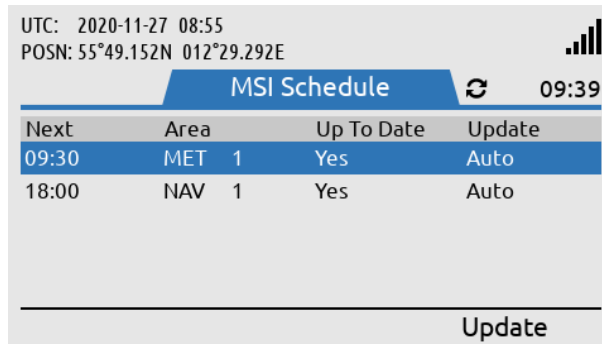

The MSI Schedule will show a list of the NAV-/METAREAs and Coastal Warning Areas receiving MSI information from.

Figure 156: GMDSS submenu (MSI Schedule)

NOTE: The MSI Schedule illustrated in Figure 156 shows a LT-3100S GMDSS system located in NAV-/METAREA 1 (~United Kingdom I). The entire list of NAV-/METAREAs is shown in Table 35 on page 123. The entire list of Coastal Warning Areas (CWA) is shown in Table 36 on page 124.

The column 'Next' is providing information about the next time when the LT-3100S GMDSS system will receive MSI information from the Iridium GMDSS System (IGS). This time will be offset randomly (up to XX minutes) to handle countless GMDSS terminals, therefore the 9 minutes difference, as illustrated in Figure 156. The column 'Update' is indicating Auto, which informs that the MSI retrieve will happen automatically at the time specified.

Manual Update

The user of the LT-3100S GMDSS system can always use the soft key 'Update' to check and retrieve MSI messages. The manual update function is optional and not required to use at any time. The manual update function can be used to retrieve MSI messages at an earlier time if one needs this. The use of the manual update function is illustrated in Figure 157 and Figure 158.

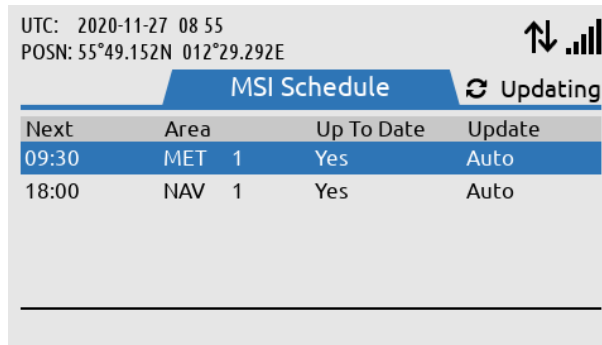

The soft key 'Update' has been used. The LT-3100S GMDSS system will check for MSI information available.

Figure 157: GMDSS submenu (MSI Schedule)

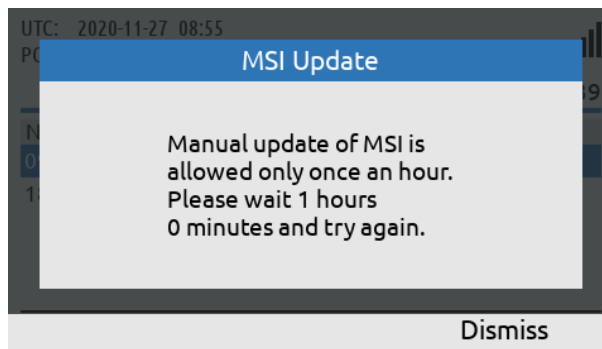

The Manual MSI Update is only allowed to be used once an hour (and user restricted).

Figure 158: GMDSS submenu (MSI Schedule)

As soon as the manual update button has been activated, the LT-3100S GMDSS system will start retrieve MSI messages from the Iridium GMDSS System (IGS). This is indicated by the updating symbol rotating and data symbol in the status bar. The user is only allowed to use the manual update button once an hour and will be restricted by a pop-up informing the user when the manual update function can be used again.

Additional NAV-/METAREA or CWA

If the user of the LT-3100S GMDSS system has configured additional NAV-/METAREAs or Coastal Warning Areas (see *MSI Settings* on page 107), then these additional areas will be listed in the MSI Schedule, see Figure 159. The column 'Update' for the additional configured NAV-/METAREAs and Coastal Warning Areas (CWA) will be indicating Manual. The MSI messages from areas indicating Manual will be retrieved automatically at the 'Next' time from the areas indicating Auto. It is always possible to use the soft key 'Update' to check for all MSI messages valid for the LT-3100S GMDSS system configuration.

Next	Area	Up To Date	Update
09:30	MET 1	Yes	Auto
11:00	MET 19	No	Manual
18:00	NAV 1	Yes	Auto
18:30	NAV 19	No	Manual

This LT-3100S GMDSS system has been configured with NAV-/METAREA 19 (Norway) as an additional Sea Area to receive MSI information from.

Figure 159: GMDSS submenu (MSI Schedule)

NOTE: All NAV-/METAREAs and Coastal Warning Areas (CWA) from where the LT-3100S GMDSS system periodically will receive MSI messages from (typically NAV and MET MSI providers) will be listed in the MSI Schedule. NAV-/METAREA and Coastal Warning Area (CWA) in which the LT-3100S GMDSS system is in and nearby, will always be shown in the MSI Schedule. For NAV-/METAREAs nearby is defined as 300 NM / for Coastal Warning Areas (CWA) nearby is defined as 100 NM.

MSI Settings

The MSI Settings menu is handling all configuration options related to reception of Maritime Safety Information (MSI).

The MSI Settings window has the following menu path: MENU -> GMDSS -> MSI Settings

The MSI Settings has the following optional configuration items:

- NAVAREA / METAREA
- Coastal Warning Areas
- Coastal Warning Services
- Area By Fixed Position

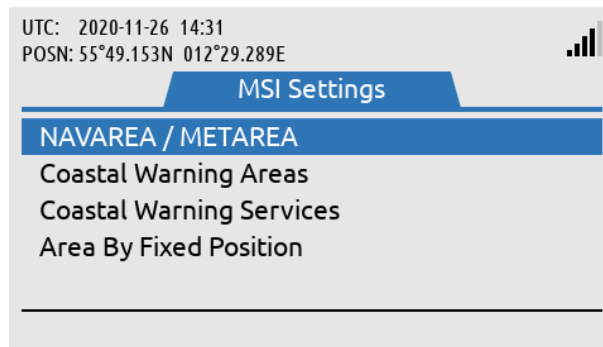

MSI Settings:
MENU -> GMDSS -> MSI Settings

Figure 160: GMDSS submenu (MSI Settings)

NOTE: The LT-3100S GMDSS system will always receive the mandatory MSI information, which are relevant for the current NAV- / METAREA and Coastal Warning Area, in which the terminal is located and nearby.

NAVAREA / METAREA

The LT-3100S GMDSS system can be configured to receive MSI information from NAVAREA / METAREAs, in which the terminal is not located. The following figures, Figure 161 to Figure 164, illustrates how to add NAVAREA / METAREAs in order to receive MSI information from these areas.

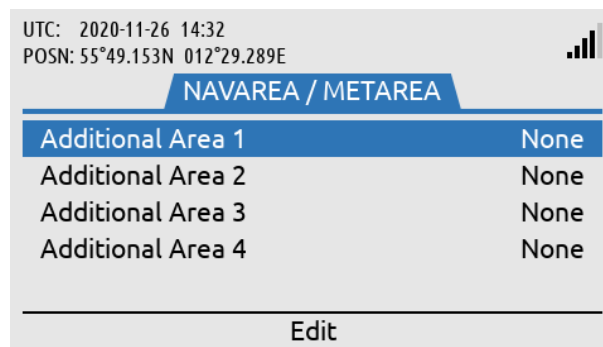

In the NAVAREA / METAREA additional Sea Areas can be added to receive MSI information from (up to 4).

Figure 161: MSI Settings, NAV-/METAREA (1 of 4)

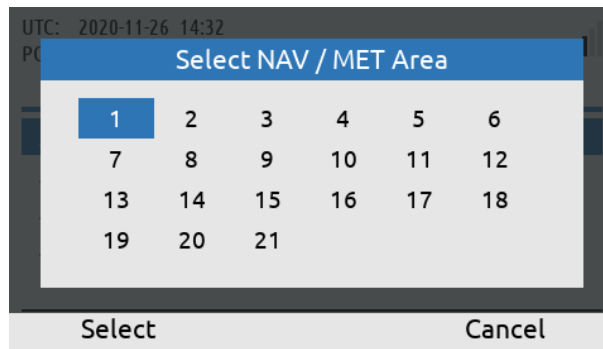

Select the NAV / MET Area to be added to the configuration.

Figure 162: MSI Settings, NAV-/METAREA (2 of 4)

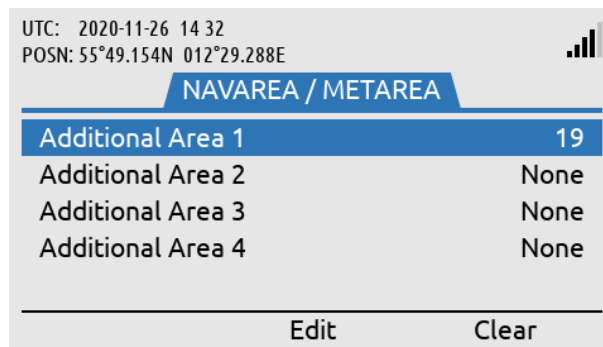

NAV-/METAREA 19 (Norway) has been added to the configuration list.

Figure 163: MSI Settings, NAV-/METAREA (3 of 4)

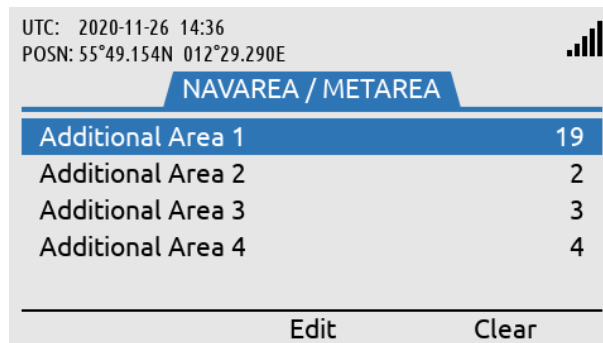

Up to 4 additional NAV / MET Areas can be added to the configuration list.

Figure 164: MSI Settings, NAV-/METAREA (4 of 4)

NOTE: It is possible to add up to four additional Sea Areas, from which you would like to receive MSI information from. The current Sea Area, in which you are currently located, can be added as one of the four additional Sea Areas. You will always receive MSI information from the Sea Area, in which you are currently located. In order to identify the sea area, in which you are currently located, see *Location Information* on page 122.

Coastal Warning Areas

The LT-3100S GMDSS system can be configured to receive MSI information from Coastal Warning Areas, in which the terminal is not located. The MSI Settings configuration of the Coastal Warning Areas in this section has no impact on the MSI Settings configuration of the NAVAREA / METAREA in the previous section. Both MSI Settings will add geographical areas to the current Sea Area (and maybe Coastal Warning Area), in which the terminal is in and nearby, and will by default receive MSI Information from. The number of Coastal Warning Areas represented in each Sea Area is very different and can vary from 0 to A - Z.

The following figures, Figure 165 to Figure 169, illustrates how to add Coastal Warning Areas in order to receive MSI information from these areas.

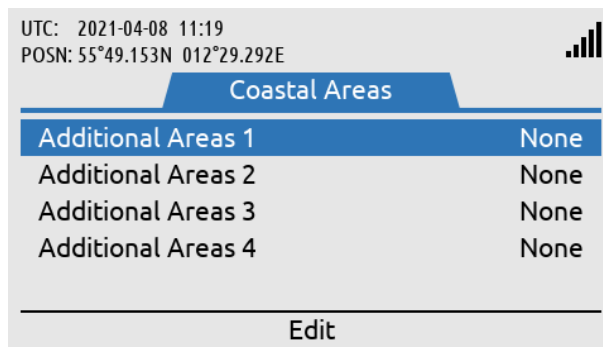

Coastal Warning Areas:
MENU -> GMDSS -> MSI
Settings -> Coastal Warning
Areas

Figure 165: MSI Settings, Coastal Warning Areas (1 of 5)



Select NAVAREA
responsible for the Coastal
Warning Area/-s to be
added to the configuration
list.

Figure 166: MSI Settings, Coastal Warning Areas (2 of 5)

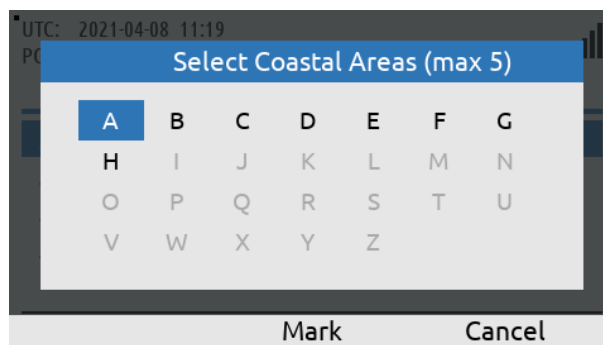

Mark Coastal Warning
Areas to be added to the
configuration list (can
individually be marked or
not).

Figure 167: MSI Settings, Coastal Warning Areas (3 of 5)

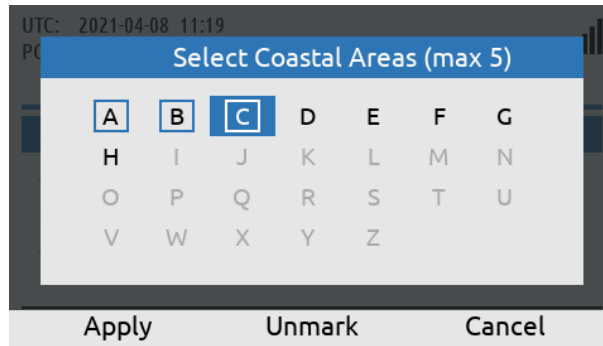

On-going marking of the Coastal Warning Areas to be added. Use the soft key 'Apply' when completed.

Figure 168: MSI Settings, Coastal Warning Areas (4 of 5)

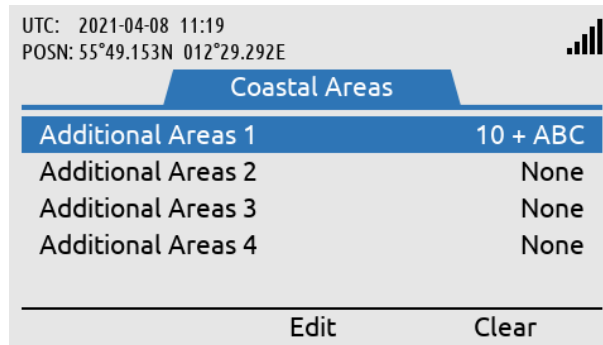

Coastal Warning Areas: A, B, and C in NAVAREA 10 has been added to the list of areas, in which the system will now receive MSI information from.

Figure 169: MSI Settings, Coastal Warning Areas (5 of 5)

In the MSI Settings configuration of the Coastal Warning Areas, as illustrated in Figure 169 above, it is only the Coastal Warning Areas: A, B and C (located in NAVAREA 10) which are added to the MSI reception. If the user of the LT-3100S GMDSS system would like to receive MSI messages from NAVAREA / METAREA 10, then make sure to add this Sea Area in the MSI Settings as described in NAVAREA / METAREA and as illustrated in Figure 161 on page 107.

NOTE: It is possible to add up to four additional NAVAREA / Coastal Warning Areas (A-Z), in which you would like to receive MSI information from. The current Coastal Warning Area, in which you are currently in, can be added as one of the four additional Coastal Warning Areas (A-Z). You will always receive MSI information from the Coastal Warning Area, in which you are currently in (if located in a Coastal Warning Area). In order to identify the Coastal Warning Area, in which you are currently located, see *Location Information* on page 122.

NOTE: It is only possible to configure up to 5 Coastal Warning Areas for a given NAVAREA.

Coastal Warning Services

The Coastal Warning Area in which you are located and the Coastal Warning Areas that you have configured optionally have some mandatory and optionally services. The Coastal Area Services applied will be valid for all Coastal Warning Areas watched. The Coastal Warning Services are illustrated in Figure 170 and the complete list of services are available in Table 34.

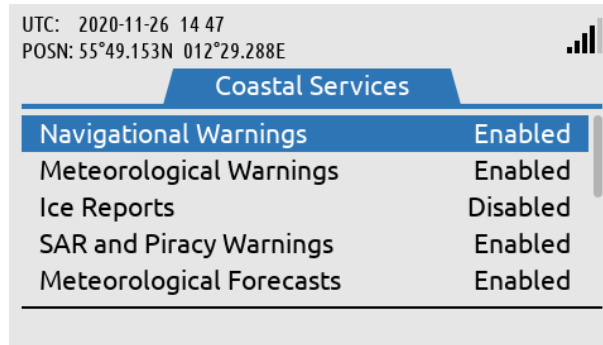

Coastal Warning Services:
MENU -> GMDSS -> MSI
Settings -> Coastal
Warning Services

Figure 170: MSI Settings, Coastal Warning Services (1 of 2)

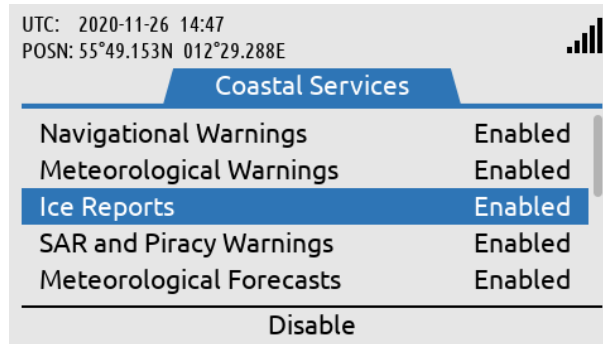

Enabling of Ice Reports
for all Coastal Warning
Areas illustrated.

Figure 171: MSI Settings, Coastal Warning Services (2 of 2)

Coastal Warning Services		
Service	Default Settings	User Configurable
Navigational Warnings	Enabled	No
Meteorological Warnings	Enabled	No
Ice Reports	Disabled	Yes
SAR and Piracy Warnings	Enabled	No
Meteorological Forecasts	Enabled	No
Pilot Service Messages	Disabled	Yes
AIS	Disabled	Yes
LORAN Messages	Disabled	Yes
SATNAV Messages	Disabled	Yes
Other Nav aids Messages	Disabled	Yes
Other NAV Warnings	Disabled	Yes

Table 34: MSI Settings, Coastal Warning Services

NOTE: In Figure 171 it is illustrated that Ice Reports has been enabled for Coastal Warning Areas. This setting will apply to all Coastal Warning Areas watched.

Area By Fixed Position

As an alternative to configure MSI Settings for NAVAREA / METAREA and Coastal Warning Areas, Area By Fixed Position can be configured for receiving MSI information from a predefined position of interest. The user of the LT-3100S GMDSS system can configure a static position (latitude / longitude) with a fixed radius of 300 NM. All NAVAREA / METAREA and Coastal Warning Areas intercepted and included in this fixed circle will be added to the list of Sea Areas Sea Areas, in which the terminal will receive MSI information from.

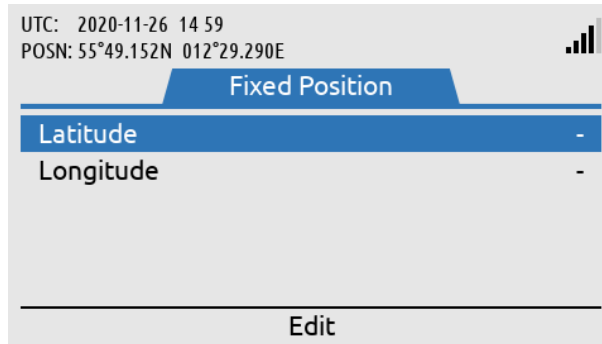

Area By Fixed Position:
MENU -> GMDSS -> MSI
Settings -> Area By Fixed
Position

Figure 172: MSI Settings, Area By Fixed Position (1 of 3)

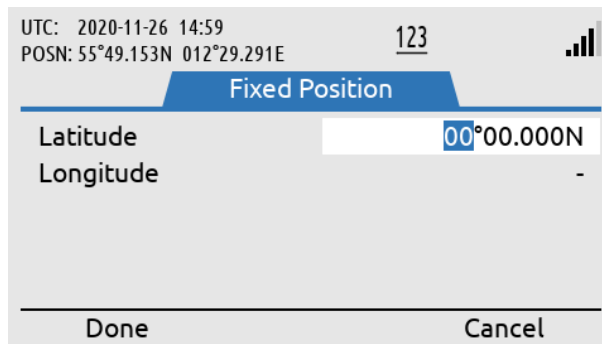

Inserting position (latitude
and longitude) in order to
receive MSI information
from this point of interest.

Figure 173: MSI Settings, Area By Fixed Position (2 of 3)

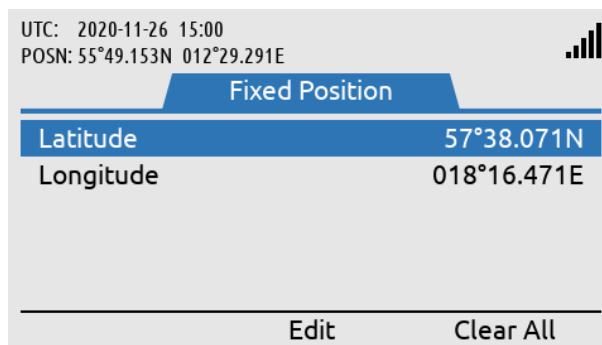

Position inserted and
Area By Fixed Position
activated.

Figure 174: MSI Settings, Area Fixed By Position (3 of 3)

NOTE: MSI Settings Area By Fixed Position is an alternative to configure NAVAREA / METAREA and Coastal Warning Areas in order to receive MSI information from a predefined position of interest.

Distress Settings

The LT-3100S GMDSS system has a submenu from where all relevant Distress Settings can be configured. The Distress Settings window has the following menu path: MENU -> GMDSS -> Distress Settings

The Distress Settings window consist of the following configuration items:

- Distress RCC
- Auto-dial
- Nature of Distress

The configuration items will be further described in the next sections.

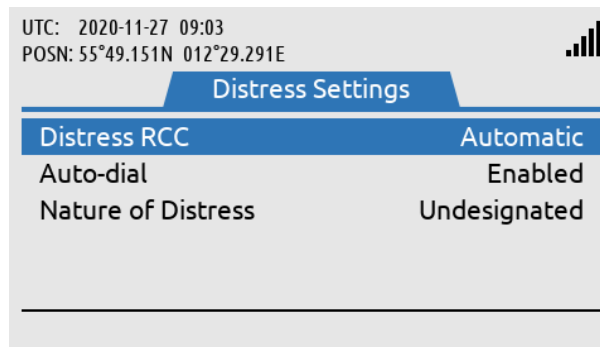

Distress Settings:
MENU -> GMDSS ->
Distress Settings

Figure 175: GMDSS submenu (Distress Settings)

Distress RCC

The Distress Settings, Distress RCC can be configured to the following options:

- Automatic
- Manual

The Distress RCC recommended setting is Automatic. The Distress RCC has been configured during completion of the Installation Wizard, see *Installation Wizard* on page 61. In Automatic mode the Distress Alert, Distress Call, Safety Calling and Safety Messaging (Distress, Urgency, or Safety) will be routed to the RCC responsible for the Sea Area, in which the vessel is located. In Distress RCC Manual mode the specific RCC selected will be used for routing the Distress Alert, Distress Call, Safety Calling and Safety Messaging (Distress, Urgency, or Safety) regardless of where the vessel is located.

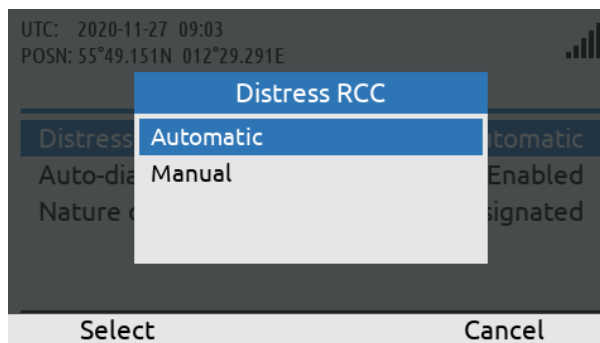

Use the Navigation key to select Automatic or Manual RCC.

Figure 176: Distress Settings, Distress RCC (1 of 3)

NOTE: The user of the LT-3100S GMDSS system can always enter the Distress Settings, RCC Settings and change the setting of the Distress RCC between Automatic and Manual mode.

The following figures, Figure 177 and Figure 178, illustrates how the user of the LT-3100S GMDSS system can change Distress RCC from Automatic to Manual mode. In Manual mode the specific Distress RCC selected will be displayed in the Distress Settings window. In this example: East_TEST_RCC has been configured.

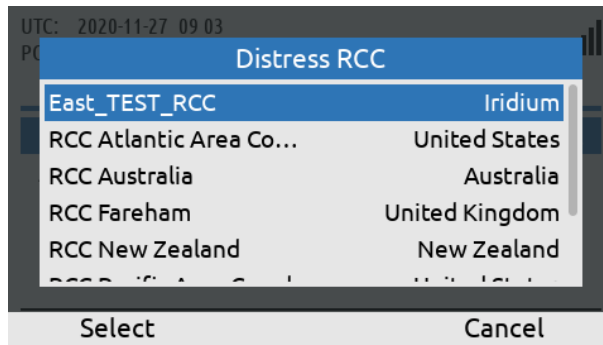

If Distress RCC, Manual has been selected, then the user of the LT-3100S GMDSS system can select an RCC from a list.

Figure 177: Distress Settings, Distress RCC (2 of 3)

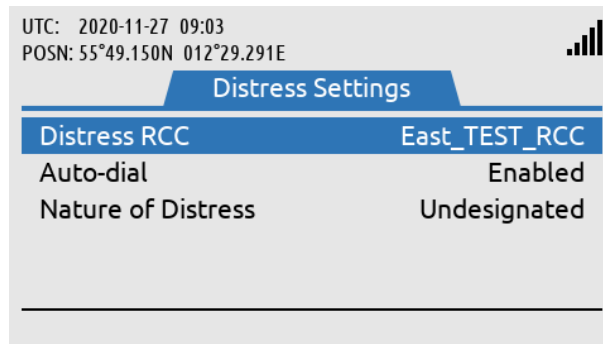

The Manual RCC selected will be shown in Distress Settings with its RCC name.

Figure 178: Distress Settings, Distress RCC (3 of 3)

NOTE: During completion of the Installation Wizard and whenever there are changes to the GMDSS configuration file received from the Iridium GMDSS System (IGS), the LT-3100S GMDSS system will get the latest version of the GMDSS configuration file, which may contain changes to e.g. the RCC Contacts. The user of the LT-3100S GMDSS system should expect that Iridium will add new RCCs frequently after introducing the Iridium GMDSS Service.

Auto-dial

The Distress Settings, Auto-dial can be configured to the following options:

- Enabled
- Disabled

The default setting of the Auto-dial is Enabled. It is always possible to configure the Auto-dial setting at any time after the Installation Wizard has been completed.

If the Auto-dial is configured to Enabled, then the LT-3100S GMDSS system will automatically call the RCC, if the DISTRESS button has been activated and once the Distress Alert messages has been delivered to the Iridium GMDSS System (IGS). The Distress Alert and Distress Call is described in further details in *Distress Alert & Distress Call* on page 78.

The following figures, Figure 179 and Figure 180, illustrates how the user of the LT-3100S GMDSS system can change Auto-dial from Enabled to Disabled.

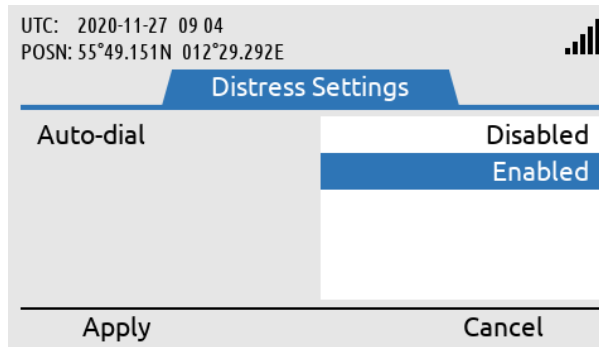

Figure 179: Distress Settings, Auto-dial (1 of 2)

Auto-dial:
MENU -> GMDSS -> Distress Settings -> Auto-dial

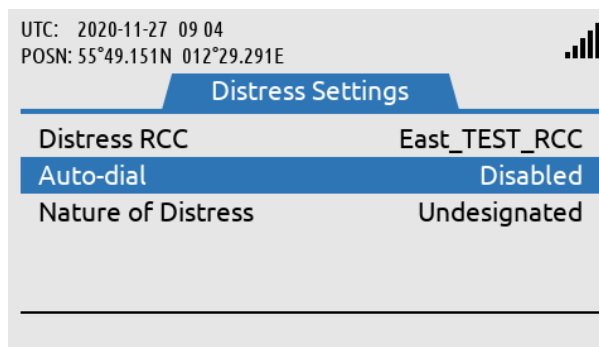

Figure 180: Distress Settings, Auto-dial (2 of 2)

Auto-dial configured to Disabled (the LT-3100S GMDSS system will not automatically make a Distress Call to the RCC).

NOTE: The Auto-dial configuration is by default set to Enabled, which means that the LT-3100S GMDSS system automatically will call the RCC after a Distress Alert messages has successfully been delivered to the Iridium GMDSS System (IGS), after the DISTRESS button has been pushed and held for a minimum 3 seconds.

Nature of Distress

The Distress Settings, Nature of Distress can be configured to the following options:

- Undesignated
- Fire/explosion
- Flooding
- Collision
- Grounding
- Listing
- Sinking
- Disabled and adrift
- Abandoning ship
- Piracy/armed attack
- Man overboard

There are two methods of configuring Nature of Distress when the user of the LT-3100S GMDSS system is sending a Distress Alert message to the RCC:

- 1) When the DISTRESS button has been activated an initial Distress Alert message will be sent to the RCC (Nature of Distress = Undesignated). Hereafter, the user of the system can use the soft key 'Select Nature', and an updated Distress Alert message will now be sent with the chosen Nature of Distress information. This method is illustrated and described in details in *Distress Alert & Distress Call* on page 78.
- 2) The user of the LT-3100S GMDSS system must navigate to MENU -> Distress Settings -> Nature of Distress and configure the Nature of Distress that must be informed to the RCC. Hereafter the operator of the system pushes the DISTRESS button and activates the Distress Alert message. The Initial Distress Alert message will contain the Nature of Distress information configured.

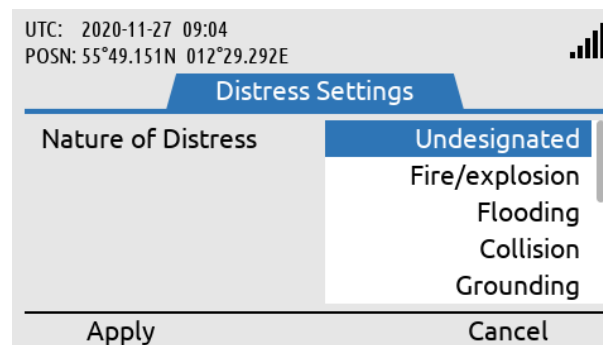

Nature of Distress:
MENU -> GMDSS -> Distress
Settings -> Nature of
Distress

Figure 181: Distress Settings, Nature of Distress

NOTE: By default, Nature of Distress is configured to Undesignated. It is always possible to send an updated Distress Alert message to the RCC, where the Nature of Distress information is provided or changed. If Distress Settings, Nature of Distress is not configured in the LT-3100S GMDSS system, then Undesignated will be sent in the initial Distress Alert message to the RCC.

Position Settings

The LT-3100S GMDSS system is default configured to use the built-in GNSS receiver, Automatic (GNSS) mode, for determining the current position of the vessel. The position is primarily used for:

- Distress Alert sent to the RCC upon activation of a Distress
- Location information updates sent to the Iridium GMDSS System (IGS)

In case the built-in GNSS receiver has a malfunction or if the user for some other reason (e.g. GNSS spoofing) is required to manually enter the current position of the vessel, this can be done in Position Settings (MENU -> GMDSS -> Position Settings).

The following instruction will help you change Position Settings from Automatic to Manual mode:

1. Select Source of Position and press ENTER
2. Select Manual Input and press ENTER
3. Fill in the Latitude and Longitude fields
4. Fill in the Time of Position field with the time in UTC at which the vessel was at the position entered in the Latitude and Longitude fields (*note*: This may not be the current time)
5. The Course over Ground (COG) and Sped over Ground (SOG) are optional and can be set to zero if unknown
6. When all fields have been assigned a value, press the soft key 'Apply' to apply the manual position

NOTE: The LT-3100S GMDSS system is by default configured to Automatic (GNSS) position mode. The manual position mode should only be used, if the Automatic (GNSS) position mode is not providing valid information.

The Position Settings illustrated in Figure 182 shows the LT-3100S GMDSS system configured to Automatic (GNSS) position mode.

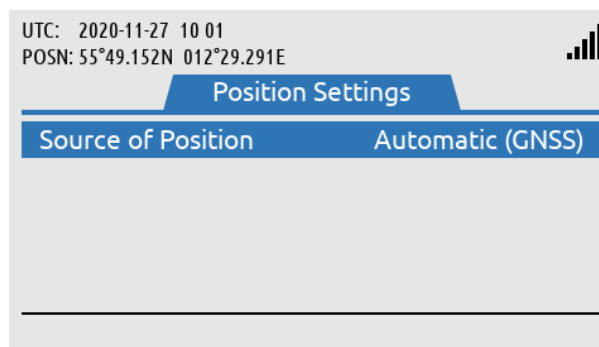

Position Settings:
MENU -> GMDSS -> Position
Settings

Figure 182: Position Settings, Manual Position (1 of 12)

Figure 182 to Figure 193 illustrates how the Position Settings, Source of Position is changed from Automatic (GNSS) to Manual position mode.

NOTE: Please be aware that, if manual position mode is set, while the LT-3100S GMDSS system has no valid position from the GNSS receiver, the system will automatically switch to automatic mode, as soon as it gets a valid position (3D fix).

Manual Position

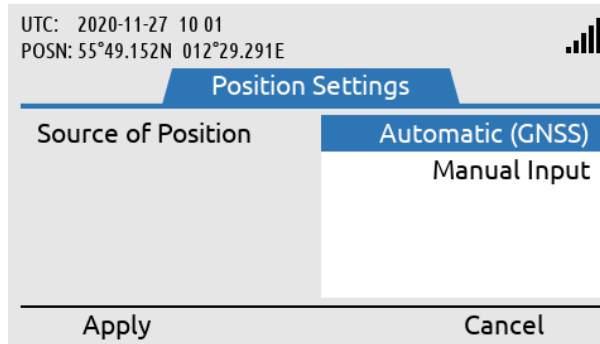

Source of Position is changed from Automatic (GNSS) to Manual Input. Use the soft key 'Apply'.

Figure 183: Position Settings, Manual Position (2 of 12)

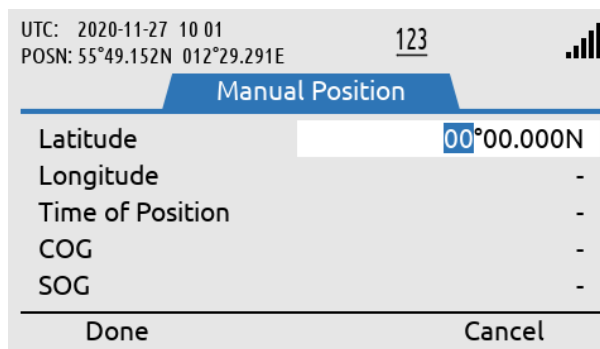

Latitude is configured. Use the soft key 'Done', when Latitude has been entered correctly.

Figure 184: Position Settings, Manual Position (3 of 12)

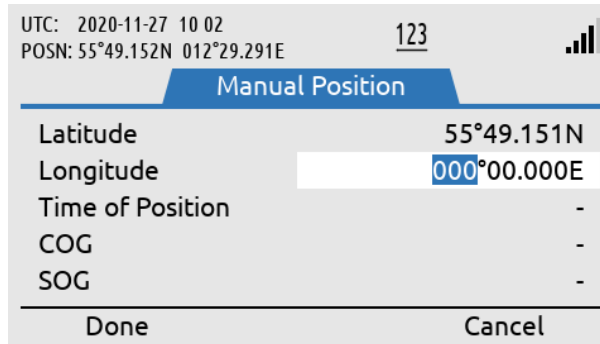

Longitude is configured. Use the soft key 'Done', when Longitude has been entered correctly.

Figure 185: Position Settings, Manual Position (4 of 12)

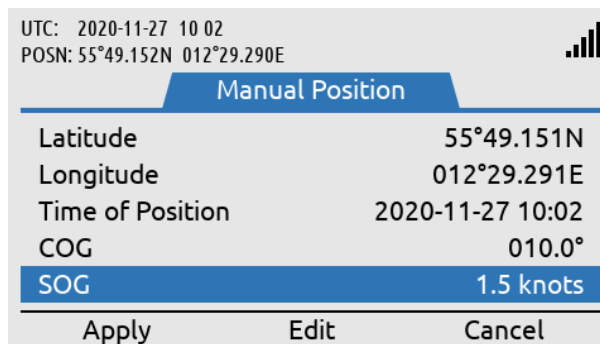

Time of Position, COG, and SOG must be entered. Use soft key 'Apply' when all inputs have been entered correctly.

Figure 186: Position Settings, Manual Position (5 of 12)

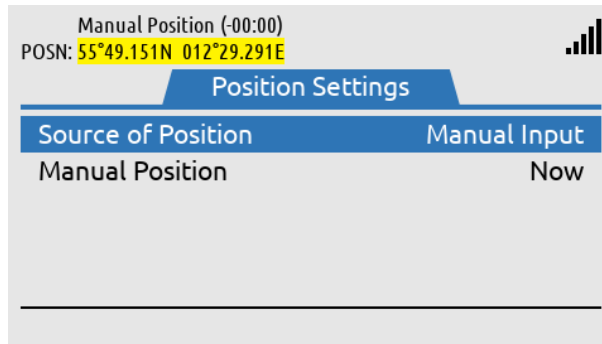

Manual Position is now being used as the position in the system. See information in the status bar (position is colored yellow to indicate low integrity).

Figure 187: Position Settings, Manual Position (6 of 12)

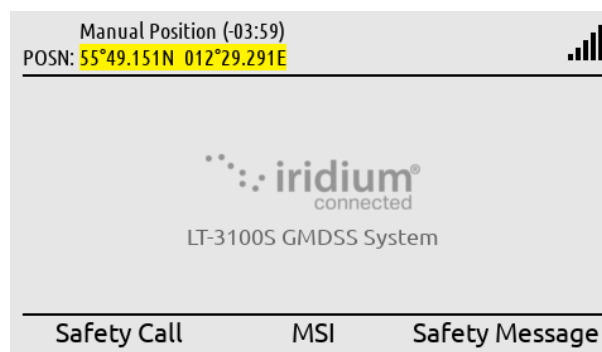

In the status bar the age of the Manual Position is shown. (-03:59) indicates that the position is three hours and 59 minutes old.

Figure 188: Position Settings, Manual Position (7 of 12)

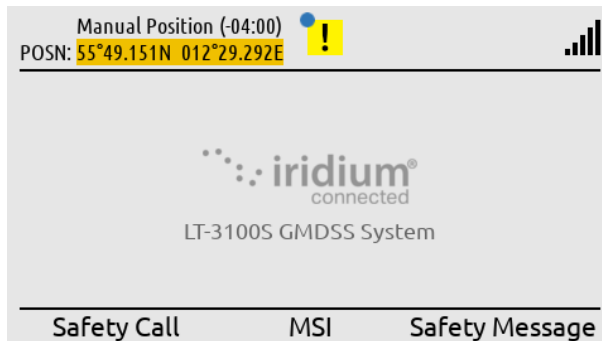

When the Manual Position is more than 4 hours old, a BAM alert caution (doubtful pos) will be raised.

Figure 189: Position Settings, Manual Position (8 of 12)

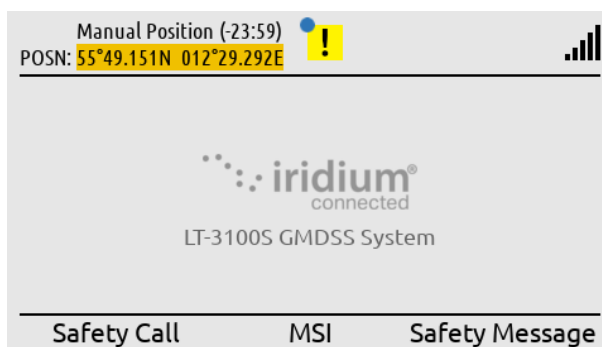

The manual position will be colored orange to indicate invalid until it has been updated.

Figure 190: Position Settings, Manual Position (9 of 12)

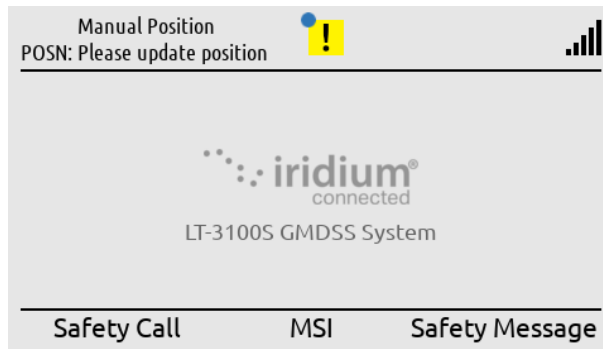

When the Manual Position is older than 24 hours the status bar will indicate “POSN: Please update position”.

Figure 191: Position Settings, Manual Position (10 of 12)

Update Manual Position

In manual position mode the position must be updated every 4 hours. A BAM alert active caution (doubtful pos) will be activated when the manual position is older than 4 hours. The position will be colored yellow to indicate low integrity when in manual position mode and colored orange when the position is older than 4 hours to indicate invalid. Make a long press on the MENU button to access the BAM Alerts. Hereafter press the soft key ‘Review’ to update the manual position.

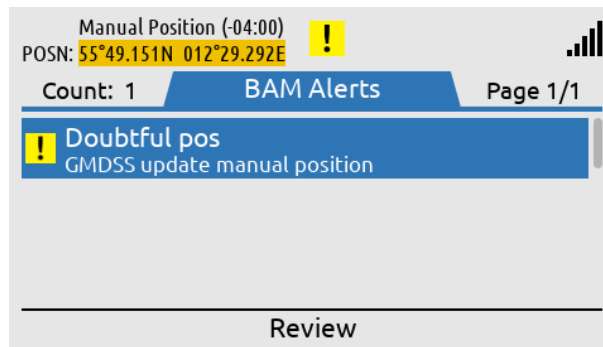

BAM alert active caution (doubtful pos) available since Manual Position is older than 4 hours.

Figure 192: Position Settings, Manual Position (11 of 12)

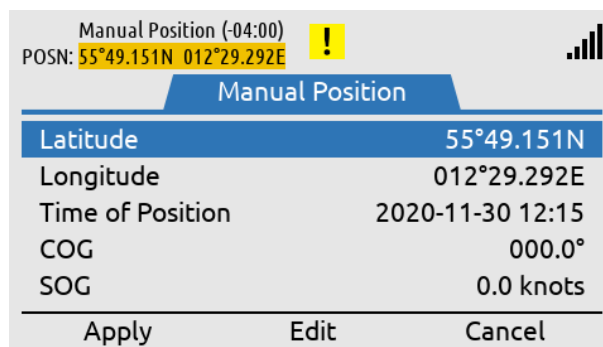

By pressing the soft key ‘Review’ it is possible to update the Manual Position.

Figure 193: Position Settings, Manual Position (12 of 12)

NOTE: In manual position mode the position must be updated every 4 hours. A BAM alert active caution (Doubtful pos) will be shown after 4 hours. The user of the LT-3100S GMDSS system must enter a new up-to-date position (MENU -> GMDSS -> Position Settings).

Printer Settings

The Printer Settings submenu is a conditional submenu and will only be present if a LT-3160S Printer Adapter is installed on the LT-3100S GMDSS system. The Printer Settings conditional submenu is seen on Figure 194.

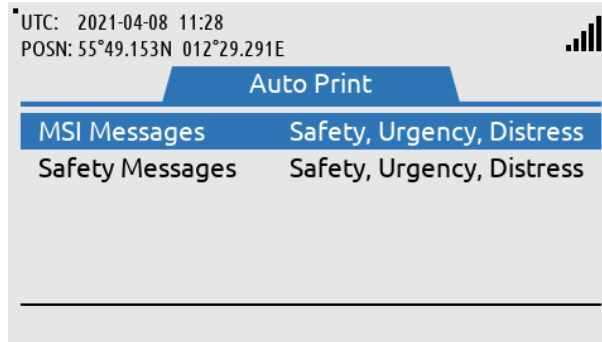

Printer Settings / Auto Print:
MENU -> GMDSS -> Printer Settings

Figure 194: Printer Settings

It is possible to configure which MSI Messages and Safety Messages are automatically printed - this is only possible if a certified printer is connected via the printer adapter. By default, the LT-3100S GMDSS system will print both MSI Messages and Safety Messages of Safety, Urgency or Distress priority. The user can configure the system to only print Urgency or Distress priority. This is configurable for both MSI Messages and Safety Messages, See Figure 194 to Figure 196.

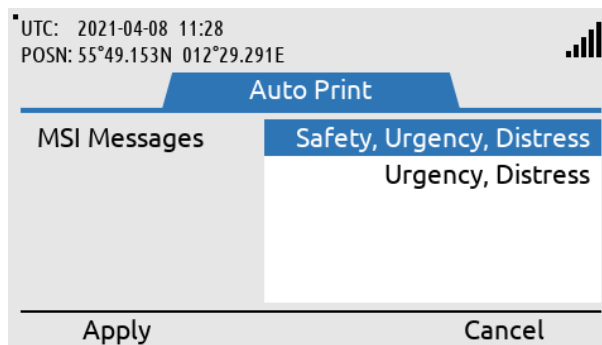

Use the navigation keys and the soft keys to change printing configuration

Figure 195: Printer Settings

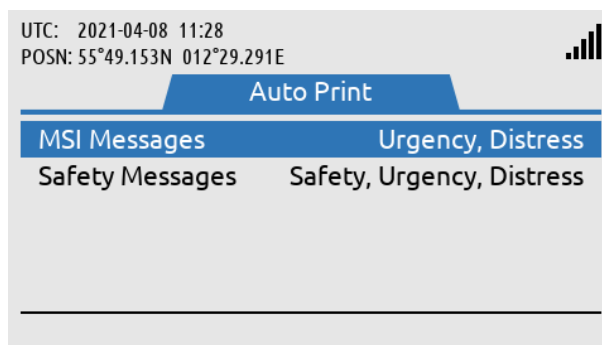

Separate printer configuration of MSI Messages and Safety Messages

Figure 196: Printer Settings

Location Information

The LT-3100S GMDSS system has a window, where it is possible to read out details about the Sea Area and responsible RCC, in which the terminal is located:

- NAVAREA
- METAREA
- Coastal Warning Area
- Responsible RCC

Location Information has the following menu path: MENU -> GMDSS -> Location Information

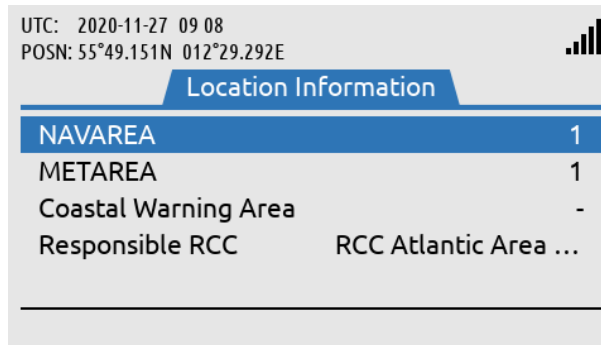

Location Information:
MENU -> GMDSS ->
Location Information

Figure 197: GMDSS submenu (Location Information)

NOTE: Location Information is read-only and is dependent on the 'Source of Position' user setting.

NAVAREA

The world is divided into 21 geographical Sea Areas identified as NAVigational AREAs (NAVAREAs) ranging from NAVAREA 1 (United Kingdom) to 21 (Russian Federation). The NAVAREAs are listed in Table 35. The NAVAREAs are used to coordinate the communication of navigational hazards to mariners.

NAVAREAs	
NAVAREA No.	Coordinator
1	United Kingdom
2	France
3	Spain
4	United States of America (East)
5	Brazil
6	Argentina
7	South Africa
8	India
9	Pakistan
10	Australia
11	Japan
12	United States of America (West)
13	Russia
14	New Zealand
15	Chile
16	Peru
17	Canada
18	Canada
19	Norway
20	Russian Federation
21	Russian Federation

Table 35: NAVAREAs

NOTE: The NAVAREAs and METAREAS MSI providers supporting the Iridium GMDSS System (IGS) and Iridium SafetyCast service are updated on the Iridium website: <https://www.iridium.com/gmdss-launch/>

METAREA

METrological AREAs (METAREAs) are identical to the geographical NAVAREAs defined above. The METAREAs are used for the purpose of sending metrological information to mariners.

Coastal Warning Area (CWA)

Coastal Warning Areas are defined in geographical areas, where the NAV/METAREAs are not sufficient to split the coastal warning areas into well-defined areas for transmission of navigational and metrological information. It is possible to configure Coastal Warning Areas in the system, in which it is desirable to receive information from, although you are not in this specific area.

Coastal Warning Areas (CWA)		
NAVAREA No.	Area	Sub-areas
10	Australia	A, B, C, D, E, F, G, and H
14	New Zealand	Z

Table 36: Coastal Warning Areas

NOTE: The Coastal Warning Areas (CWA) listed in Table 36 is reflecting the Coastal Warning Areas supported by the Iridium GMDSS system (IGS) by Commercial Service Introduction (CSI). The list of Coastal Warning Areas should be expected to change over time and more Coastal Warning Areas can dynamically be added by Iridium and will automatically be pushed to the LT-3100S GMDSS system without any user interaction.

Responsible RCC

For each NAV/METAREA there will be at least one responsible Rescue Coordination Center (RCC). All responsible RCCs supporting the Iridium GMDSS Service will automatically be ‘pushed’ to the LT-3100S GMDSS system via the GMDSS configuration file.

SES Information

The LT-3100S GMDSS System has a window, which contains registration information about the Ship Earth Station (SES). The SES Information is received from the Iridium GMDSS System (IGS), where information has been registered during commissioning of the system via an Iridium GMDSS Service Provider (SP), see *Maritime Safety Service Activation Form (MSSAF) on page 59* for further details. If information is incorrect please contact your Service Provider.

During completion of the Installation Wizard the SES Information is verified and confirmed. The SES Information is read-only. The SES Information has the following menu path: MENU -> GMDSS -> SES Information.

The SES Information contains the following information:

- SES Name
- SES MSISDN
- Vessel Name
- Vessel MMSI
- Vessel IMO No.

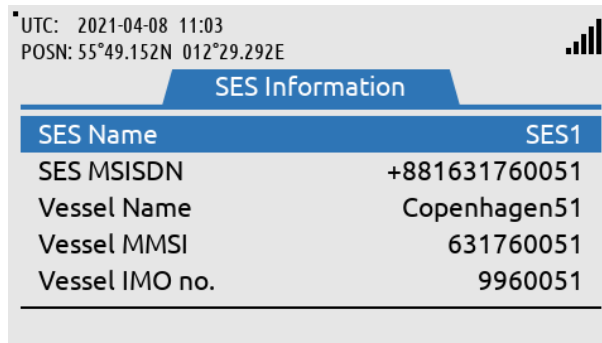

SES Information:
MENU -> GMDSS -> SES Information

Figure 198: GMDSS submenu (SES Information)

SES Name

SES Name can be configured to either SES1 or SES2, when completing the Iridium Maritime Safety Service Activation Form (MSSAF). Vessels with requirement for only one LT-3100S GMDSS system shall use SES Name = SES1. If the vessel has a requirement for dual GMDSS systems, then SES Name = SES1 and SES Name = SES2 must be registered for the two GMDSS systems onboard.

SES MSISDN

SES MSISDN is an abbreviation for SES Mobile Station International Subscriber Directory Number (MSISDN) and is a unique number identifying the satellite telephone and related to the GMDSS SIM card. It is the MSISDN number which shall be used for incoming non-priority voice calls to the LT-3100S GMDSS system. The MSISDN number is also used as calling party for outgoing non-priority voice calls.

Vessel Name

Vessel Name must be used which is registered with the local flag state and maritime registration authorities.

Vessel MMSI

MMSI is an abbreviation for Maritime Mobile Service Identity and is a 9-digit unique number used to identify vessels. The MMSI number is assigned by the local maritime authorities.

Vessel IMO No.

IMO No. is abbreviation for International Maritime Organization Number and is a unique identification number for a vessel, which must follow the ship throughout its lifetime, also by rebuilding and renaming. The IMO No. consist of the letters *IMO* followed by 7-digits.

Terminal Test

The LT-3100S GMDSS system support a ‘Terminal Test’ function, which is testing the satellite link to the Iridium GMDSS System (IGS) and performing the following individual tests: Distress Alert, Distress Call, and Maritime Safety Information (MSI). Also, LT-3150S Alarm Panel(s) and LT-3160S Printer Adapter connected via the LT-3140S Interface Unit may be tested as part of the Terminal Test. The Terminal Test function can be activated from the GMDSS submenu (MENU -> GMDSS -> Terminal Test). Figure 199 to Figure 216 illustrates the Terminal Test function.

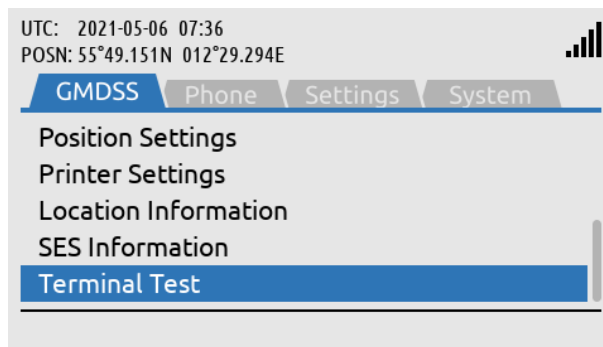

Terminal Test:
MENU -> GMDSS ->
Terminal Test

Figure 199: Terminal Test (1 of 18)

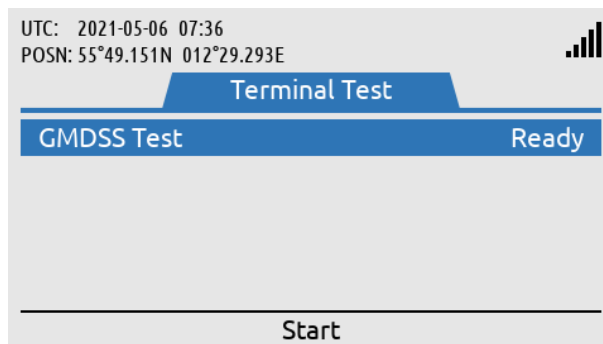

Start the Terminal Test by using the soft key ‘Start’.

Figure 200: Terminal Test (2 of 18)

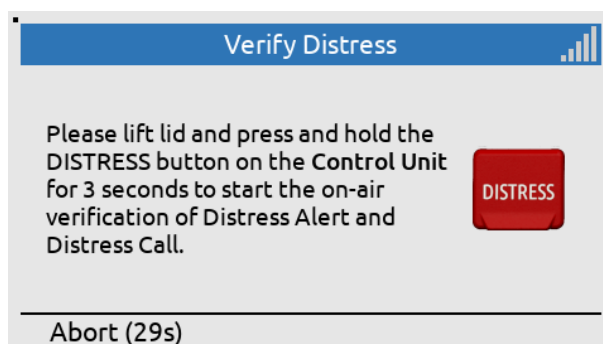

The DISTRESS button on the LT-3110S Control Unit must be used to activate the Terminal Test.

Figure 201: Terminal Test (3 of 18)

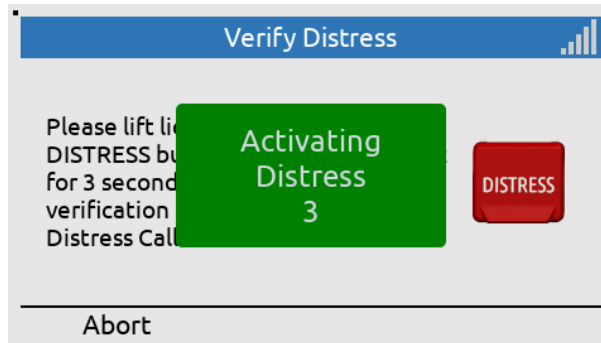

Lift the lid to the DISTRESS button and push the button for a minimum of three seconds (colored green to indicate test).

Figure 202: Terminal Test (4 of 18)

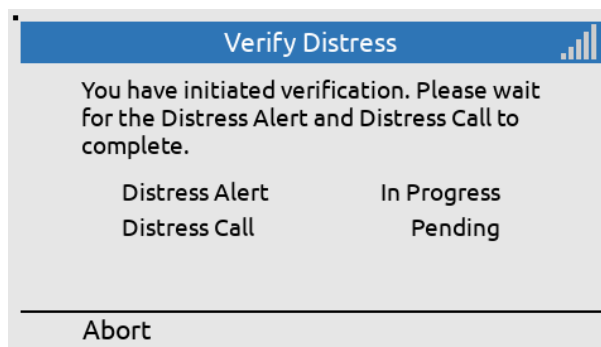

Distress Alert = In Progress
Distress Call = Pending

Figure 203: Terminal Test (5 of 18)

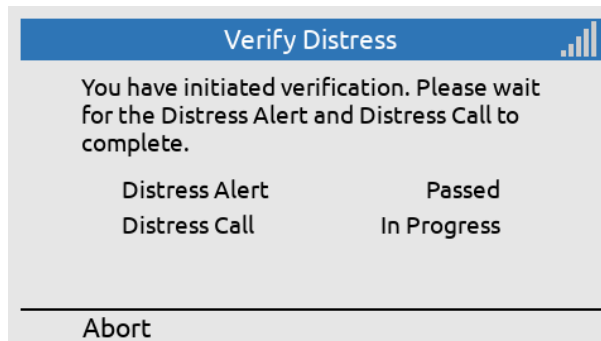

Distress Alert = Passed
Distress Call = In Progress (voice prompt available)

Figure 204: Terminal Test (6 of 18)

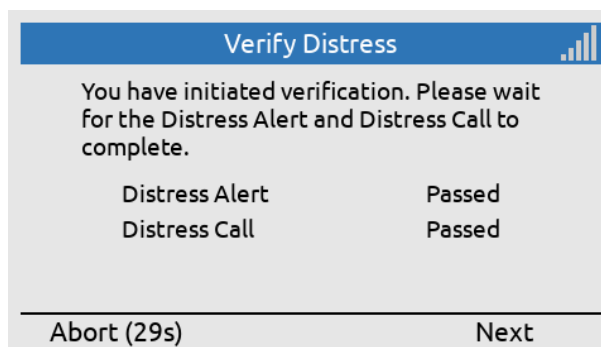

Distress Alert = Passed
Distress Call = Passed
Press the soft key 'Next' to continue.

Figure 205: Terminal Test (7 of 18)

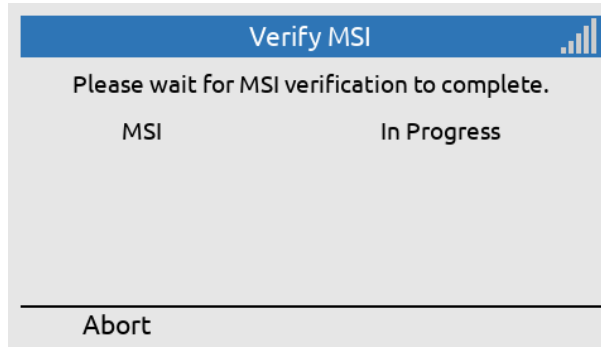

MSI = In Progress

Figure 206: Terminal Test (8 of 18)

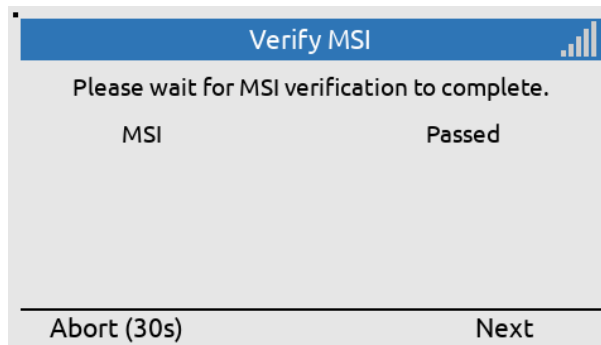

MSI = Passed
Use the soft key 'Next' to continue the Terminal Test.

Figure 207: Terminal Test (9 of 18)

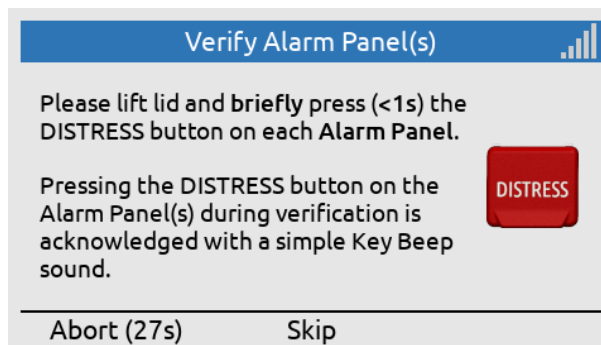

Lift the lid to the DISTRESS button on connected Alarm Panels. Only press the DISTRESS button shortly (< 1 s).

Figure 208: Terminal Test (10 of 18)

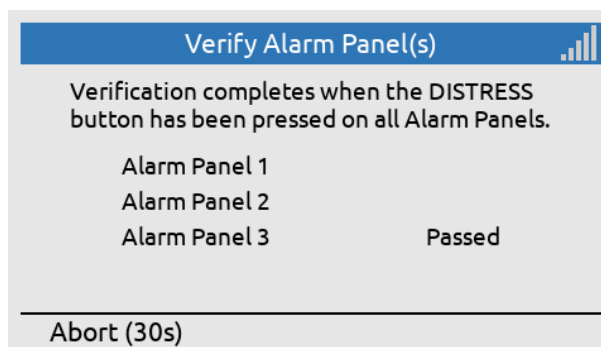

Alarm Panel 3 has been verified.

Figure 209: Terminal Test (11 of 18)

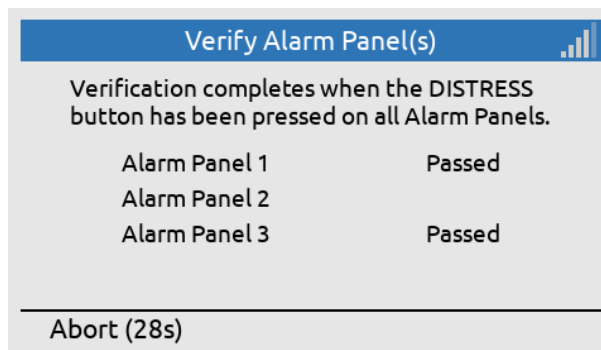

Press the DISTRESS button on all connected Alarm Panels with a short press (< 1 s).

Figure 210: Terminal Test (12 of 18)

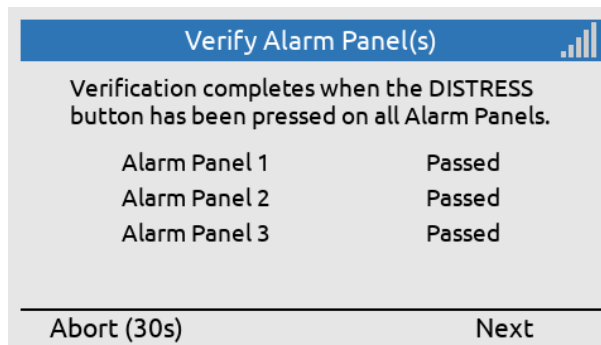

All Alarm Panels have been verified. Press Next to continue.

Figure 211: Terminal Test (13 of 18)

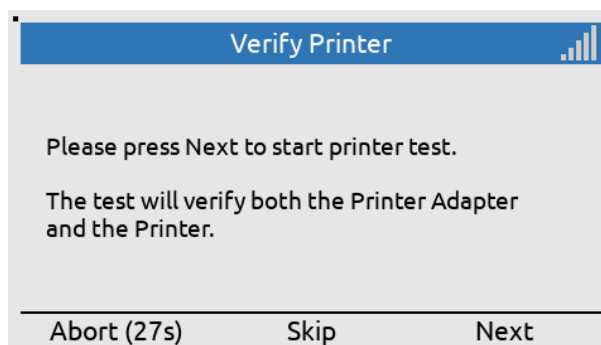

Press Next to verify Printer Adapter and connected Printer. This is only shown if a Printer Adapter and Printer is connected to the system.

Figure 212: Terminal Test (14 of 18)

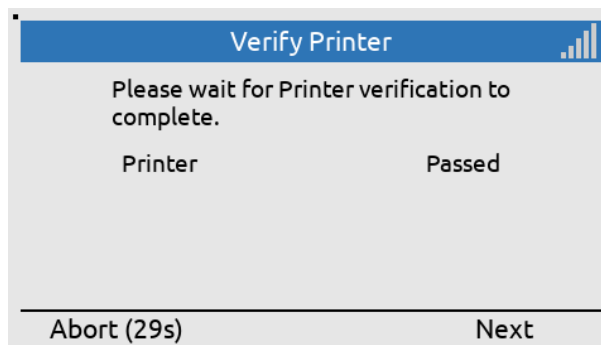

Press Next to finalize the Terminal Test.

Figure 213: Terminal Test (15 of 18)

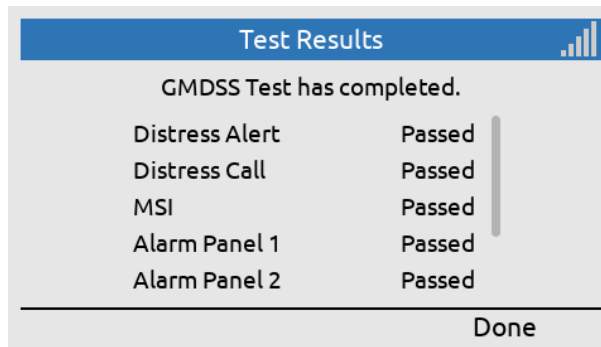

Upon finalizing the Terminal Test, the Test Results will be displayed.

Figure 214: Terminal Test (16 of 18)

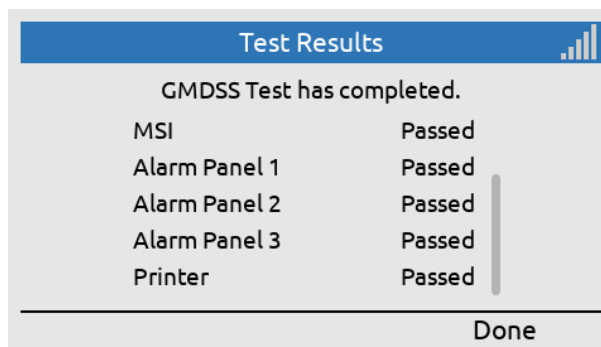

Upon pressing the 'Done' soft key, The LT-3100S GMDSS system will revert back to the default window and operation.

Figure 215: Terminal Test (17 of 18)



The LT-3100S GMDSS system is back in the default window.

Figure 216: Terminal Test (18 of 18)

NOTE: After 30 seconds of user inactivity, while a test is waiting for user input, the test will fail. When the result of a test is presented, the user has 30 seconds to continue with the next test or the Terminal Test will exit and revert to to default window and operation as illustrated in Figure 216.

NOTE: When testing external LT-3150S Alarm Panel(s) as part of the Terminal Test function, then only press the DISTRESS button with a short press (< 1 s). The short press on the DISTRESS button will be acknowledge with a key beep sound from the LT-3150S Alarm Panel. On the LT-3110S Control Unit display the LT-3150S Alarm Panel will be marked with Passed in the Terminal Test and you can continue with the verification of any additional LT-3150S Alarm Panel(s) if more LT-3150S Alarm Panels are part of the system configuration.

NOTE: The Terminal Test function will be completed when the MSI test has passed. By pressing the soft key 'Done' the user will be redirected to the default window as illustrated in Figure 214.

System Services

General Calling

The LT-3100S GMDSS system support General Calling (voice call) outgoing and incoming from phone numbers (incl. Satcom). The voice call is a non-GMDSS service (priority = Routine). The voice service must be activated by the Iridium GMDSS Service Provider in order to work, see System Submenus, *System* on page 161 (Subscription) for status: Voice Service = Subscribed or Not Subscribed. Every voice call will generate a record in the Call History placed in the Phone submenu (MENU -> Phone -> Call History), see *Phone* on page 153.

NOTE: Verify that the LT-3100S GMDSS system is ready to make or receive a voice call. Check the network registration status, as illustrated in Table 18 on page 53 (Network Status - Slot 1), which is presenting the signal level and network registration status.

NOTE: Always, make sure to have a LT-3120 Handset and LT-3121 Cradle properly installed and connected to the LT-3110S Control Unit. LT-3110S Control Unit handset connector is illustrated in Figure 2 on page 7. The LT-3100S GMDSS system will generate a BAM alert, if the LT-3120 Handset is not connected to the LT-3110S Control Unit (Lost handset).

NOTE: The LT-3100S GMDSS system is supporting connection of external SIP phones. The connection of external SIP phones is described in *External SIP Phones* on page 144.

The LT-3100S GMDSS system is supporting Mobile Originated (MO) outgoing and Mobile Terminated (MT) incoming voice calls. The following sub sections will describe and illustrate the outgoing and incoming voice calls.

Mobile Originated (MO) - Outgoing

An outgoing voice call can be established as described in Table 37.

Mode	Position of Handset	Description
on-hook	Handset placed in cradle until voice established	Type the number and use the off-hook button.
		Use the off-hook button and select the soft key 'Contacts' or 'Call History'. Select the entry and use the off-hook button to initiate the voice call.
		Navigate to Contacts or Call History by using the MENU button (MENU -> Phone -> Contacts or Call History) and use the off-hook button when the entry has been selected. The voice call will now be established.
off-hook	Handset lifted out of cradle initially	Lift the handset out of the cradle (ready tone is available). Type the number and wait 10 seconds or use the # key to initiate the voice call.

Table 37: Initiate Mobile Originated (MO) Voice Call

The voice call (on-hook and off-hook mode) will be described and illustrated on the following pages.

On-hook mode:

In on-hook mode the user can either type in the number directly in the display or use the Contacts or Call History to identify the number to be called while the handset is still placed in the cradle. Once the voice call has been established (duration starts to count) the user can lift the handset out of the cradle. The example in this section shows how to use the off-hook button, identifying an entry in the Contacts, and initiate the voice call by pressing the off-hook button.

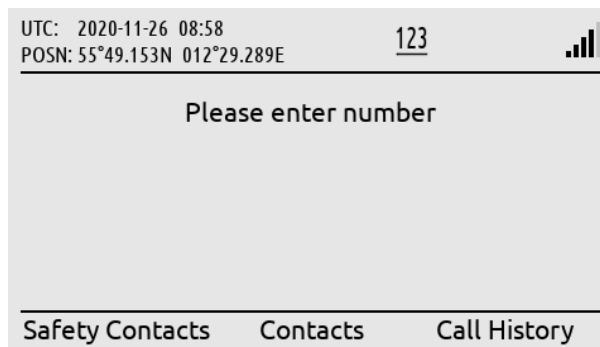

Press the off-hook button (colored green) on the LT-3110S Control Unit. Hereafter press the soft key 'Contacts'.

Figure 217: Outgoing Voice Call, on-hook mode (1 of 5)

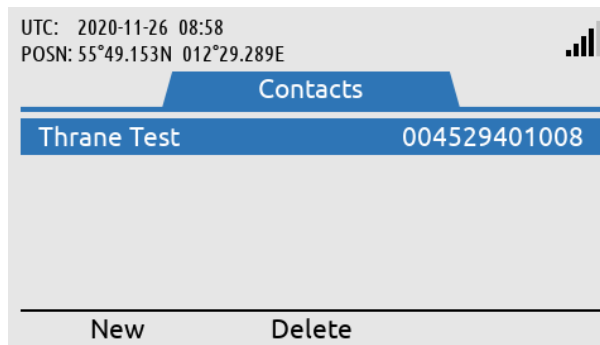

Use the Navigation key and select the contact to be dialed. Press the off-hook button to start connecting the call.

Figure 218: Outgoing Voice Call, on-hook mode (2 of 5)



The LT-3100S GMDSS system is connecting a voice call to the contact 'Thrane Test' (004529401008).

Figure 219: Outgoing Voice Call, on-hook mode (3 of 5)

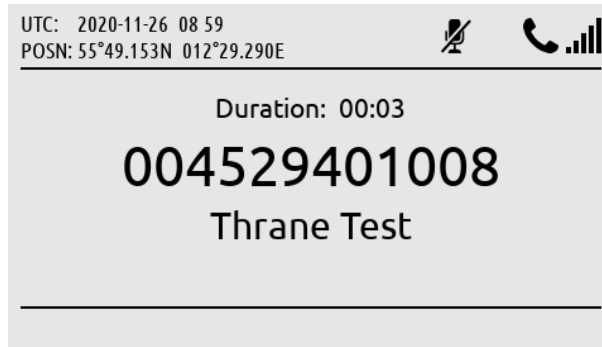

The LT-3100S GMDSS system has established a voice call to 'Thrane Test' (Duration: 00:03).

Figure 220: Outgoing Voice Call, on-hook mode (4 of 5)



The voice call can be terminated by placing the handset in the cradle or use the on-hook button (colored red).

Figure 221: Outgoing Voice Call, on-hook mode (5 of 5)

The mute symbol illustrated in Figure 220 in the status bar will disappear as soon as the handset is lifted out of the cradle. The handset will always be muted when placed in the cradle. The voice from the connected party will be available in the LT-3110S Control Unit speaker, until the handset is lifted out of the cradle. It is always possible to mute and unmute the microphone in the handset from the LT-3110S Control Unit (soft key 'Mute' and 'Unmute') when having an active call and the handset is lifted out of the cradle.

NOTE: Adding a new entry in the Contacts (MENU -> Phone -> Contacts) is described and illustrated in *Phone* on page 153.

Off-hook mode:

The off-hook mode can be activated by lifting the handset out of the cradle. In off-hook mode, the user will be met by a *ready tone* and the help text “Please enter number” - hereafter, the called number can be entered, using the numeric keypad. It is not possible to regret, if one or more wrong digits are typed in, for the dialed number. In this case, the user must on-hook the phone, and dial the correct number again. The example below shows how to establish the voice call (the other part of the voice call is identical to the on-hook mode described in the previous section).

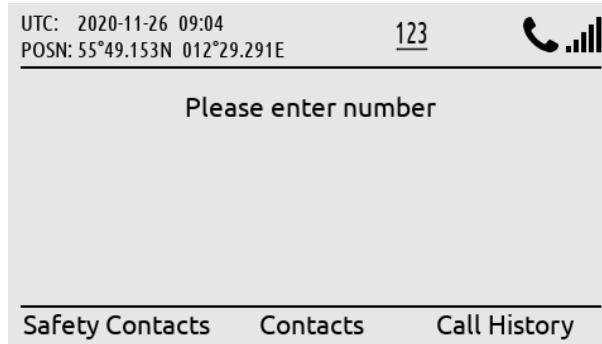

Lift the handset out of the cradle and a ‘ready tone’ will be available in the handset speaker.

Figure 222: Outgoing Voice Call, off-hook mode (1 of 3)

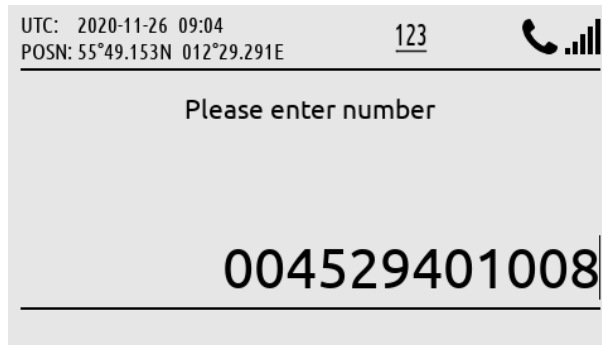

Type the number in the display by using the numeric keypad (it is not possible to regret).

Figure 223: Outgoing Voice Call, off-hook mode (2 of 3)



Use the off-hook button, # key, or wait 10 seconds for the LT-3100S GMDSS system to start connecting the voice call.

Figure 224: Outgoing Voice Call, off-hook mode (3 of 3)

NOTE: The LT-3100S GMDSS system will provide the user with information, while connecting and throughout the voice call. In case of problems with the satellite network or connection to the called party (far-end), the user will be informed through a voice prompt, and by status cause codes, that will be presented on the display (e.g. “Temporary link failure”).

Mobile Terminating (MT) - Incoming

The LT-3100S GMDSS system support receiving an incoming voice call. The calling party must use the LT-3100S GMDSS system MSISDN number. The LT-3100S GMDSS system MSISDN number is identified in the GMDSS submenu (MENU -> GMDSS -> SES Information), see *SES Information* on page 125. The LT-3100S GMDSS system will check the calling number up against the Contacts entries, if a match exists, the name of the contact will be showed for the incoming voice call.



Incoming voice call available in the LT-3100S GMDSS system.

Figure 225: Incoming Voice Call (1 of 3)



The handset has been lifted out of the cradle and the voice call is established.

Figure 226: Incoming Voice Call (2 of 3)



The voice call can be muted. To mute/unmute the handset microphone during a voice call, use the soft key 'Mute' and 'Unmute'.

Figure 227: Incoming Voice Call (3 of 3)

NOTE: The General Calling (priority = routine) voice call must be activated by the Iridium GMDSS Service Provider (SP) in order to work. Check subscription status in the System submenu (MENU -> System -> Subscription Status), see *System* on page 161.

An incoming missed voice call is illustrated in the following figures: Figure 228 to Figure 230. By pressing the soft key 'Missed Calls(1)' the user will be redirected to the Call History (filter: Missed Calls). By pressing the soft key 'Show All', all Call History records will be shown (all incoming and outgoing calls).

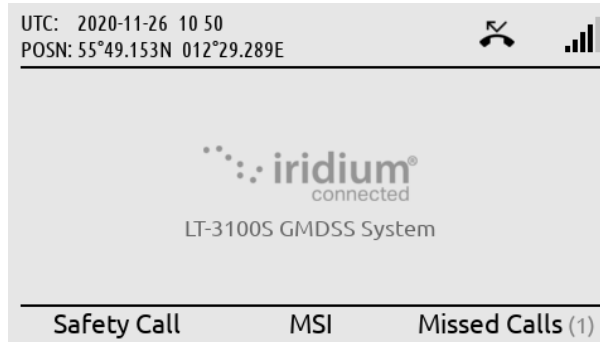

A missed voice call is illustrated in the display (symbol in status bar and soft key showing 'Missed Calls(1)').

Figure 228: Incoming Voice Call, missed (1 of 3)

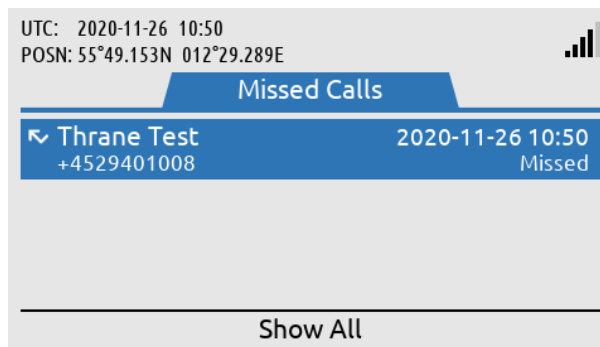

By pressing the soft key 'Missed Calls(1)' the user will be directed to the Call History (Missed Calls).

Figure 229: Incoming Voice Call, missed (2 of 3)

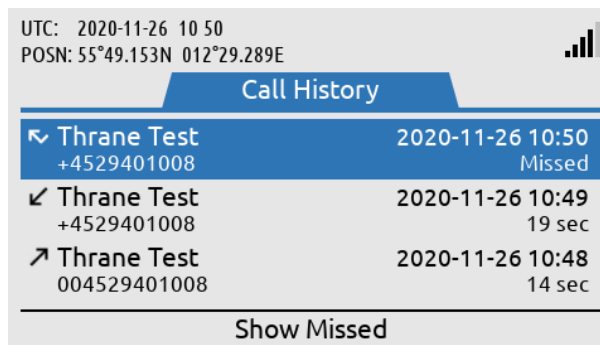

Press the soft key 'Show All' and the normal view of the Call History will be shown.

Figure 230: Incoming Voice Call, missed (3 of 3)

NOTE: An incoming missed voice call is illustrated in the above figures. By highlighting the missed call in the Call History and press the off-hook button, the LT-3100S GMDSS system will start establishing a voice call to the party.

General Messaging (SMS)

The LT-3100S GMDSS system support General Messaging (SMS) sending and receiving from traditionally phone numbers (incl. Satcom) and E-mail addresses. SMS is a non-GMDSS service (priority = Routine). The SMS service must be activated by the Iridium GMDSS Service Provider in order to work, see *System Submenus, System* on page 161 (Subscription) for status: SMS Service = Subscribed or Not Subscribed.

The LT-3100S GMDSS system support sending and receiving concatenating SMS (SMS' consisting of multiple instances). A standard SMS (single instance) is consisting of 160 characters. A concatenated SMS send from the LT-3100S GMDSS system is delivered as individual SMS' (error in the network). A concatenated SMS received in the LT-3100S GMDSS system is received and displayed correctly.

Sending an E-mail from the LT-3100S GMDSS system is handled similar to sending a SMS, although it is needed manually to insert the E-mail address in the 'To:' field (use the # key to toggle between numbers and letters). If sending an E-mail to the LT-3100S GMDSS system, then leave the Subject-field empty. Please note that all text larger than an SMS (160 characters) is truncated and that the length of the E-mail address + one character is deducted from the payload text. When sending an E-mail to the LT-3100S GMDSS system, then the MSISDN number must be used (e.g. 88163XXXXXX@msg.iridium.com). Don't use international prefix ('+' or '00' in front of the MSISDN number).

The SMS Service is located in the Phone submenu (MENU -> Phone -> SMS), as illustrated in Figure 231.

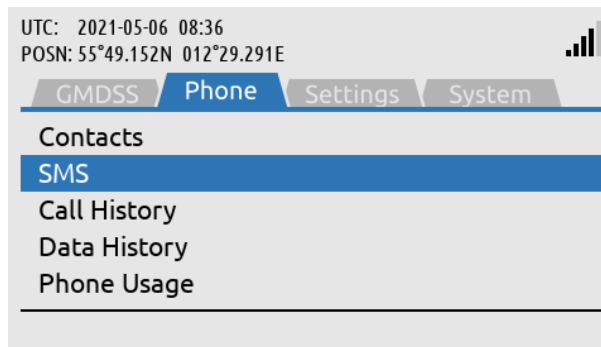

General Messaging (~SMS):
MENU -> Phone -> SMS

Figure 231: Phone submenu (General Messaging ~SMS)

NOTE: The LT-3100S GMDSS system support SMS sending and receiving from traditionally phone numbers (incl. Satcom) and E-mail addresses. The SMS Service must be activated with the Iridium GMDSS Service Provider (SP).

NOTE: The LT-3100S GMDSS system can store minimum 500 SMS' in total (sent and received). An individual SMS or SMS conversations can be deleted from the SMS window. To delete all SMS' at once, navigate to the Settings submenu (MENU -> Settings -> Reset Options: Delete SMS Messages).

Sending SMS

To send a SMS, the user of the LT-3100S GMDSS system must access the Phone submenu (MENU -> Phone -> SMS). In the SMS window all sent and received SMS are visible. In Figure 232 the SMS window is illustrated with 'No Messages'. Press the soft key 'New' to prepare a new SMS. It is possible to reply to an existing conversation (phoner number, E-mail address) when entries are available. Figure 232 to Figure 236 illustrates sending a new SMS (to a normal phone number).

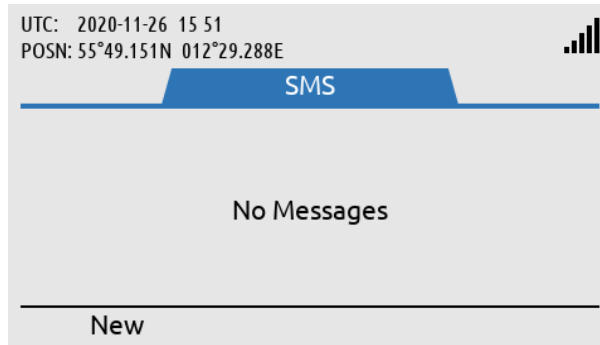

No SMS' are available in the LT-3100S GMDSS system (sent or received). Use soft 'New' to prepare a new SMS.

Figure 232: Sending SMS (1 of 7)

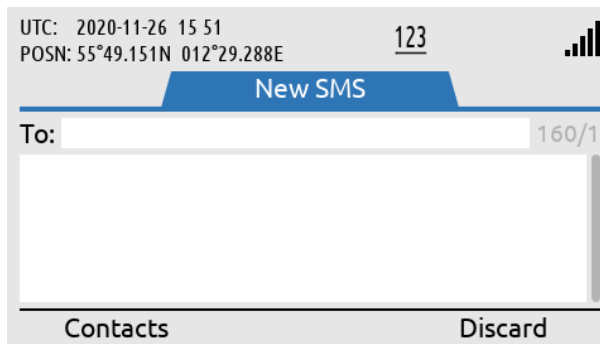

Use soft key 'Contacts' or enter the number directly in the To-field.

Figure 233: Sending SMS (2 of 7)

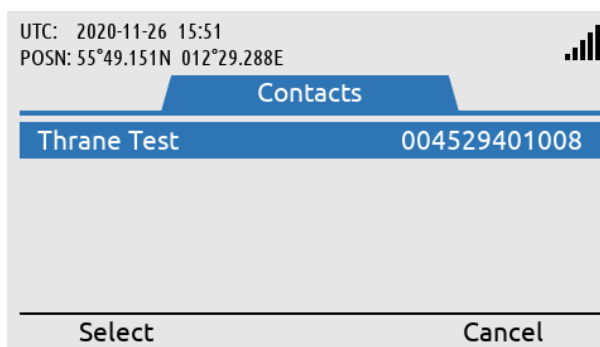

If Contacts has been chosen, then select the contact by using the Navigation key and the soft key 'Select'.

Figure 234: Sending SMS (3 of 7)

NOTE: Use the # key to toggle between numbers and letters in the 'To:' field (needed when sending to an E-mail address destination).

Press the soft key 'Send' when the destination address and body text have been completed. The SMS service will indicate the transmitting status, which will change from 'Sending' to 'Sent' when the SMS has successfully been sent from the LT-3100S GMDSS system, see Figure 237 and Figure 238.

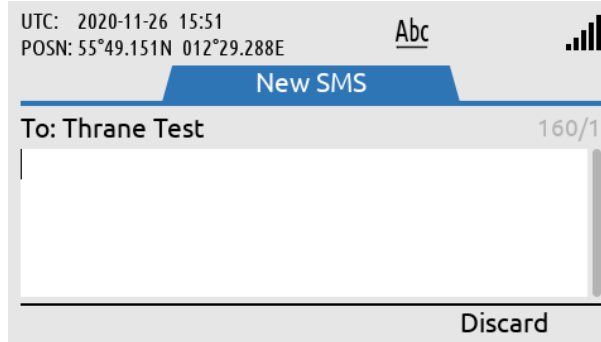

Write the SMS text.

Figure 235: Sending SMS (4 of 7)

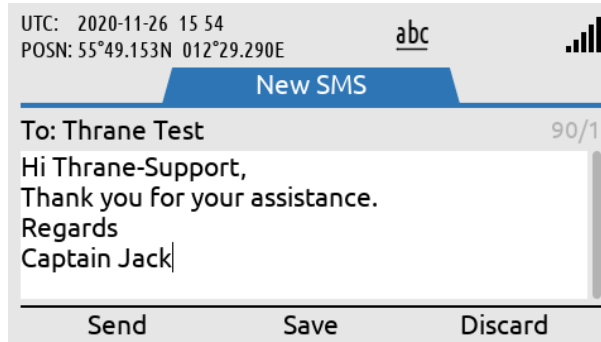

When the SMS is ready to be sent use the soft key 'Send'.

Figure 236: Sending SMS (5 of 7)

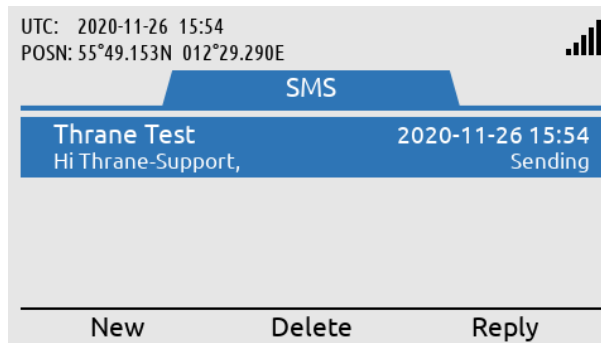

The SMS will change status from Sending to Sent when the SMS has successfully been sent.

Figure 237: Sending SMS (6 of 7)

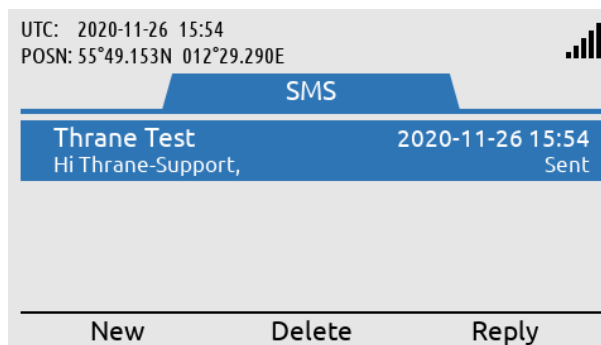

The SMS has successfully been sent. Otherwise, retry option is available.

Figure 238: Sending SMS (7 of 7)

NOTE: If sending the SMS is failing (the SMS window will indicate 'Failed'), then a 'Resend' soft key will be available for the user to make another try. A successful SMS sending will be indicated by 'Sent' - this information will be replaced by 'Now' and hereafter the time since the SMS was successfully sent (e.g. '19 hours ago' and so forth).

Receiving SMS

A received SMS will be indicated by the unread symbol in the status bar, a notification tone, and the soft key 'SMS(1)' will be shown as illustrated in Figure 239 (if no unread Safety Messages are available).

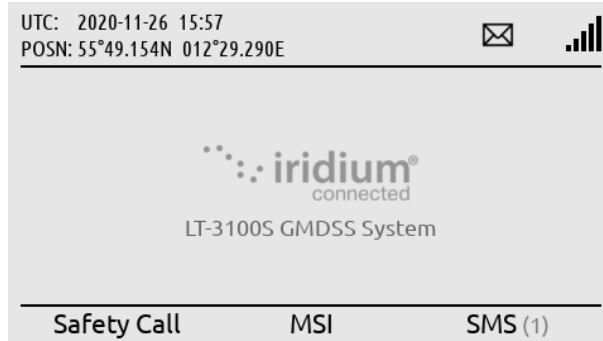

The LT-3100S GMDSS system has received a SMS, see symbol in status bar and soft key 'SMS(1)'.

Figure 239: Receiving SMS (1 of 3)

To read the incoming SMS, press the softkey 'SMS(1)' or navigate to the Phone submenu (MENU -> Phone -> SMS). The unread symbol will be removed as soon as the SMS has been read. Open the individual SMS or SMS conversation by pressing the ENTER button. Use the soft key 'Reply' to reply to a sent or received SMS.

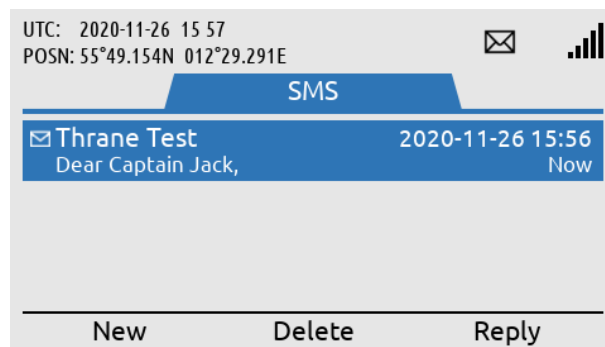

Press the soft key 'SMS(1)' and the user will be directed to the SMS window.

Figure 240: Receiving SMS (2 of 3)

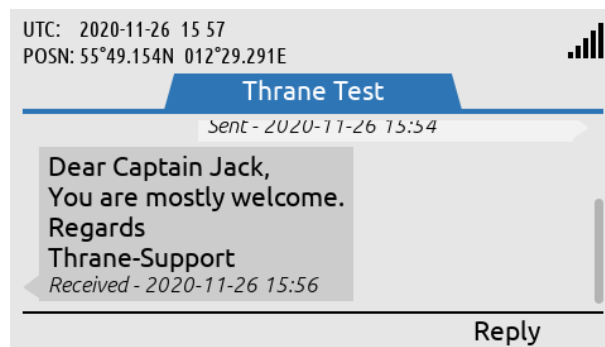

Use the ENTER button to open the received SMS.

Figure 241: Receiving SMS (3 of 3)

NOTE: The LT-3100S GMDSS system is handling SMS conversions, which is grouped based on the recipient's address.

External SIP Phones

The LT-3100S GMDSS system is supporting connection of external SIP phones, up to 8 external SIP phones. The configuration of the SIP phones must be completed via the web server, see *SIP* on page 190. Figure 242 is illustrating the connection of the external SIP phones. Connect the SIP phones directly to the LT-3110S Control Unit Ethernet (LAN port) or via the LT-3140S Interface Unit (use the spare LAN ports).

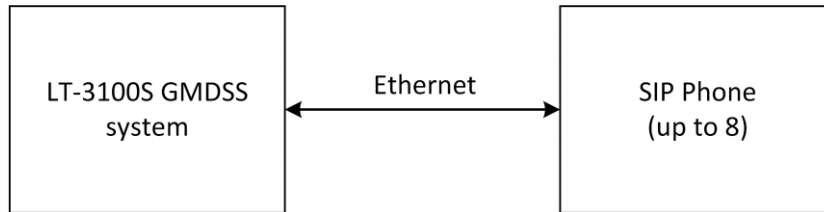
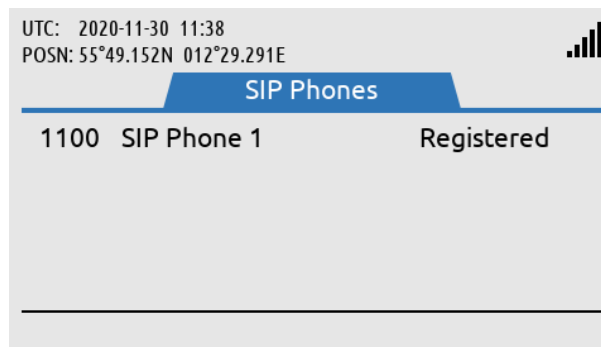

Figure 242: SIP phones

NOTE: The SIP phone might require a DHCP Server to get an IP address assigned. Depending on network setup, it might be needed to configure DHCP Server mode in the LT-3100S GMDSS system.

The LT-3110S Control Unit UI display (MENU -> System -> SIP Phones) will provide a 'live' registration status of the SIP phones configured from the web server.



SIP Phones:
MENU -> System -> SIP
Phones

Figure 243: System Submenu (SIP Phones)

An active voice call to/from a SIP phone will be presented in the Status bar with the symbol showed in Figure 244. External SIP phones can only use the General Calling (priority = Routine).

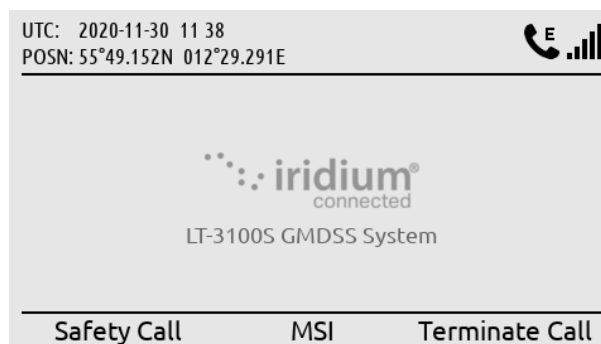

External SIP voice call is using the satellite connection. Can be terminated by using the soft key 'Terminate Call'.

Figure 244: External SIP Voice Call

By using the soft key 'Terminate Call', the external voice call from the SIP phone will be terminated. A voice call from an external SIP phone will automatically be preempted, if a service with higher priority (Safety, Urgency, or Distress) is presented.

An incoming voice call taken by the SIP phone cannot be forwarded. Once a voice call has been taken by any of the 'lines' the voice call is locked to this user.

The LT-3100S GMDSS system is supporting local calling between the SIP phones and the LT-3120 Handset. The number plan is illustrated in Table 38. The Caller ID is defined by the user, when configuring the SIP phones.

LT-3100S GMDSS System Number Plan (local calls)		
Number	Caller ID	Comments
1000	LT-3100S User	LT-3120 Handset
1100	SIP Phone 1	
1101	SIP Phone 2	
1102	SIP Phone 3	
1103	SIP Phone 4	
1104	SIP Phone 5	
1105	SIP Phone 6	
1106	SIP Phone 7	
1107	SIP Phone 8	

Table 38: Number Plan (local calls)

NOTE: The LT-3100S GMDSS system is only supporting one outgoing satellite voice connection. A local call between two local users will not busy the Satellite voice connection.

Analogue Phone Adapter

The LT-3100S GMDSS system is supporting connection of an external Analogue Phone Adapter (e.g. Grandstream). The number of POTS' phones (Plain Old Telephone System), which can be connected to the Analogue Phone Adapter, must be configured as SIP phones in the LT-3100S GMDSS system, see configuration of SIP phones in *SIP* on page 190. Connect the SIP phones directly to the LT-3110S Control Unit Ethernet (LAN port) or via the LT-3140S Interface Unit (use the spare LAN ports).

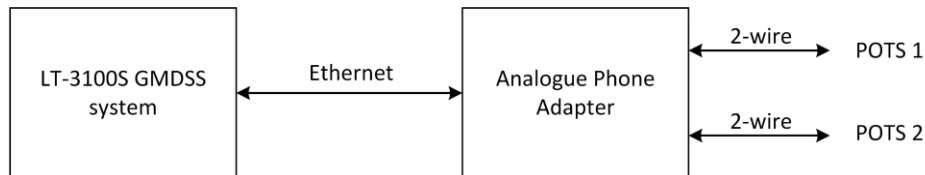

Figure 245: Analogue Phone Adapter

NOTE: The Analogue Phone Adapter might require a DHCP Server to get an IP address assigned. Depending on network setup, it might be needed to configure DHCP Server mode in the LT-3100S GMDSS system.

The Analogue Phone Adapter (POTS phones) will be handled as SIP phones in the LT-3100S GMDSS system. Therefore, carefully read the section describing the SIP phones in section *External SIP Phones* on page 144.

In order to provide some guidance for configuration of an Analogue Phone Adapter, the following description will outline some important steps for configuring an Analogue Phone Adapter.

Configuration of Grandstream HT802 Adapter (example):

If you would like to connect the Analogue Phone Adapter directly to the LT-3100S GMDSS system, then it might help you to insert a passive switch between the LT-3100S GMDSS system and the Analogue Phone Adapter, while completing the setup (to allow for an extra LAN port during configuration).

- Step 1: Connect the LT-3100S GMDSS system, Analogue Phone Adapter, and PC using a passive switch
- Step 2: Login to the LT-3100S GMDSS system web server. The IP address can be read from the display (MENU -> System -> Network: IP address)
- Step 3: Configure the LT-3100S GMDSS system to 'DHCP Server' mode (depending on network setup) and configure the SIP phones (Password, and Caller ID)
- Step 4: The Analogue Phone Adapter will now have an IP address assigned. Connect a POTS phone to the Analogue Phone Adapter and use the IVR menu to read out the IP address (off hook handset and type '***' followed by '02'). Check the instructions provided for the Analogue Phone Adapter
- Step 5: Log in to the Analogue Phone Adapter and configure FXS PORT 1 and PORT 2 (Primary SIP Server, SIP User ID, Authenticate ID, Password, and Name)
- Step 6: The POTS phones should now be registered and ready to use (the passive switch can be removed)

Data (Modem Data & SMS)

The LT-3100S GMDSS System is supporting a serial asynchronous automatic dialing and control interface (V250). The interface makes it possible for external equipment (DTE) to use the Iridium 2.4 kbps Modem Data (Direct Internet and RUDICS) service. Also, the Iridium SMS service is available over this serial interface.

The Modem Data ‘Direct Internet’ service is used for Dial-up Networking, whereas the Modem Data ‘RUDICS’ service is commonly used for Iridium Service Providers e.g. to support e-mail programs.

The LT-3110S Control Unit offers a virtual serial RS-232 interface (DCE) supporting data, control, and status signals. The serial interface is based on the Telnet Com Port Control Option network protocol (RFC 2217) and is available at the Ethernet (LAN) interface (RJ45 connector).

Access to the serial interface from a PC requires a virtual COM (or tty) port driver supporting RFC 2217 e.g., the Serial Port Redirector (from Fabulatech) on Windows and ttynvt on Mac and Linux. The virtual COM (or tty) port might be used directly by applications running on the PC (e.g., e-mail applications) or by the operating system to establish a dial-up connection to the Internet (dial-up networking).

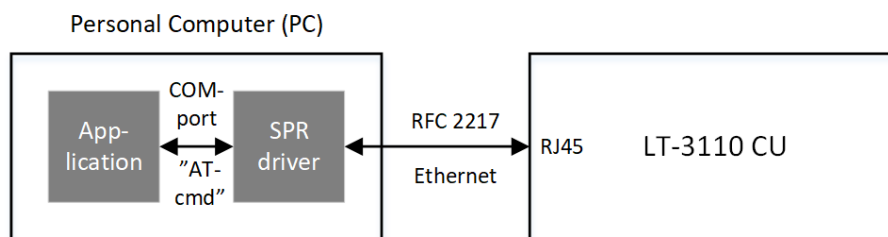

Figure 246: LT-3100S GMDSS system is supporting RFC 2217 (Serial over Ethernet)

The serial interface can be accessed by connecting to the IP address (port 5020) of the LT-3110S Control Unit. The IP address can be read out from the MENU -> System -> Network, see *System Submenus, System* on page 161. The serial interface is by default disabled and must be activated from the built-in web server, see *Web server, Data* on page 189.

NOTE: The serial interface (port 5020) must be enabled from the LT-3100S GMDSS System built-in web server to be available by any external application, see *Web server, Data* on page 189. By default, port 5020 is blocked by the built-in LT-3110S Control Unit Firewall.

The Modem Data service has priority = Routine (non-GMDSS). The Modem Data service will be preempted by the LT-3100S GMDSS system or by the Iridium GMDSS System, if a GMDSS Service (priority = Distress, Urgency, or Safety) requires this.

The LT-3110S Control Unit display will indicate, if the Modem Data service is active by showing the data symbol in the status bar and the soft key 'Terminate Data', see Figure 247.



Figure 247: Modem Data service active

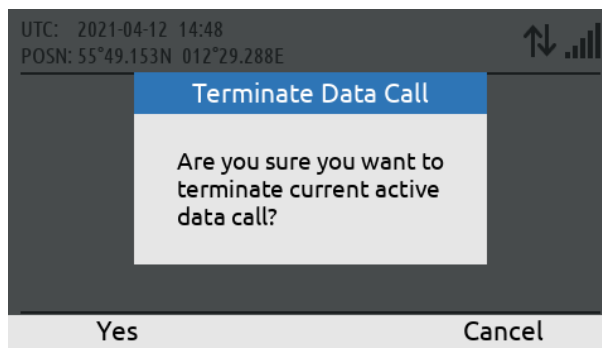

Figure 248: Modem Data service terminate

By pressing the soft key 'Terminate Data' the user of the LT-3100S GMDSS system can manually terminate the Modem Data connection. The user of the LT-3100S GMDSS system must confirm the termination of the Modem Data connection by pressing the soft key 'Yes'.

NOTE: The Modem Data connection may be preempted by a GMDSS Service if this is required for a service with higher priority to be delivered. Also, the Modem Data connection can manually be disconnected by pressing the soft key 'Terminate Data'.

The LT-3100S GMDSS system is supporting most of the AT-command set supported by the Iridium 9523N module. The Iridium 9523N AT-commands are available in the Iridium document: ISU AT Command Reference.

Modem Data Services & Numbers	
Service	Number
Direct Internet	008816000025
Direct Internet (Russia)	007954107030
RUDICS	Check with Iridium Service Provider or Application

Table 39: Iridium Modem Data Numbers

Installation of the Serial Port Redirector (virtual COM port) and Windows Dial-up Networking is further described in the following Lars Thrane A/S LT-3100 Tech Notes, which can be downloaded from our company website:

- LT-3100 Serial Port Redirector Tech Notes
- LT-3100 Windows Dial-up Networking Tech Notes

IMPORTANT: If the Modem Data service (Direct Internet) Windows Dial-up Networking is established to provide an IP data connection, then it is important to emphasize that no Firewall protection is supported by the LT-3100S GMDSS system. Firewall rules must be setup and configured in the PC to provide the required protection.

E-mail programs

External e-mail programs can be installed on a PC and use the Serial over Ethernet (RFC 2217) e.g., SPR Virtual COM port to establish a Modem Data connection (RUDICS) to a dedicated RUDICS server. Table 40 list several e-mail programs and companies, which can be used over an Iridium Modem Data (RUDICS) connection. Additional e-mail programs may be compatible with the LT-3100S GMDSS system and the Iridium Modem Data service.

External E-mail Programs	
SkyFile Mail	Marlink
OnSatMail	AST
GTSeaMail	GTMaritime
SpeedMail	SpeedCast
Iridium Mail & Web (RedPort Optimizer)	Pivotel (Global Marine Network)

Table 40: External E-mail programs

NOTE: It is important to validate the correct Modem Data (RUDICS) Dial-up number with the Iridium Service Provider or the respective company used. Also, make sure that the Modem Data connection is setup with the correct Modem Data service (+CBST - Select Bearer Service Type, default value: 9600 bps V.32). Further details for the AT-command set is available in the Iridium document: ISU AT Command Reference.

Tracking

The LT-3100S GMDSS system is supporting tracking functionality. The periodic tracking functionality must be configured from the LT-3100S GMDSS system web server, see Configuration - Tracking in *Tracking* on page 191. The LT-3100S GMDSS system tracking functionality is a non-GMDSS functionality, which the user of the system can configure and use for any private purpose.

The LT-3100S GMDSS system is supporting the following tracking formats:

Transport Types & Report Formats	
Transport Type	Report Format
SMS	Thrane (text) Human readable
E-mail	Thrane (text) Human readable
SBD	<i>Not supported</i>

Table 41: Tracking Transport Types & Report Format

If periodic tracking reports have been configured by the user of the LT-3100S GMDSS system in the web server, then a tracking symbol will be shown in the status bar of the LT-3110S Control Unit display. Also, this is to inform the user that tracking reports will be sent periodically.



Figure 249: Periodic Tracking Activated

The user of the LT-3100S GMDSS system can access the Tracking window (MENU -> System -> Tracking) to get some details about the periodic tracking configuration and reports. See Figure 250 on page 151 for the layout of the Tracking window.

The Tracking window shown in Figure 250 illustrates the following periodic tracking configuration:

- Time trigger: Enabled, Timer interval = 12:00 (HH:MM)
- Distance trigger: Enabled, Distance interval = 50.0 (NM), Minimum time interval = 04:00 (HH:MM)

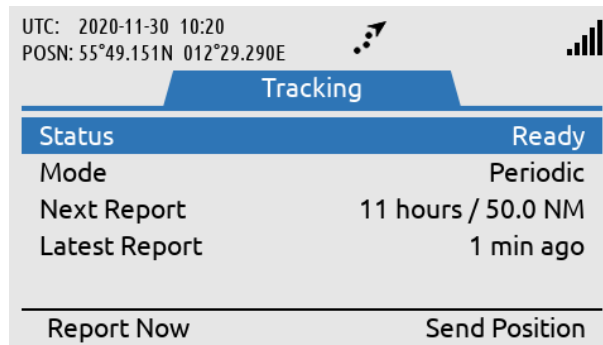

Figure 250: Tracking submenu

Last Report is indicating '1 min ago' because the soft key 'Report Now' button has been used. The soft key 'Report Now' can be used to send additional tracking reports, if tracking has been configured in the web server. Otherwise for this configuration, periodic tracking reports are to be sent every 12 hours / 50 NM (minimum time interval: 4 hours), whatever is first triggered, time or distance.

If Time and/or Distance trigger have been enabled, then Mode is set to Periodic. If none of these trigger conditions have been enabled, then Mode is set to Manual. If the Mode is configured to Manual, then only tracking configuration Options 'Send report on power-on' (configuration parameter from the web server) or the soft key 'Report Now' can activate a tracking report.

If selecting the Last Report using the Navigation key, then you will see the details of this last tracking report sent, as illustrated in Figure 251.

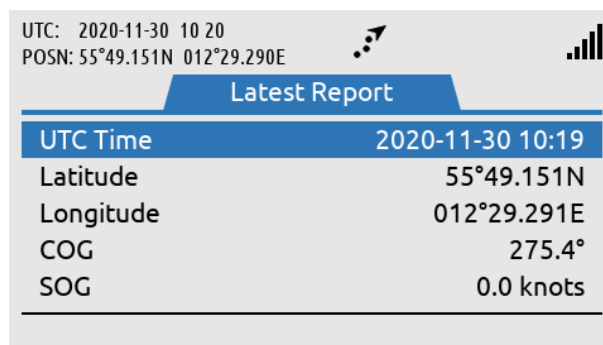

Figure 251: Tracking (Last Report)

NOTE: The LT-3100S GMDSS system support configuration of periodic tracking reports using different transport types and formats. The periodic tracking reports must be configured using the web server, see Configuration - Tracking in *Tracking* on page 191.

Instead of using the periodic tracking report, it is possible without any configuration, to send a tracking report using the Tracking window (MENU -> System -> Tracking). Use the soft key 'Send Position' as illustrated in Figure 250 on page 151.

The LT-3100S GMDSS system will preformat a tracking report using the SMS functionality and layout, where the user optionally can select between a regular subscriber number and an E-mail address. Use the hash '#' key to toggle between numbers and letters in the 'To:' field. It is possible edit the body text with optionally information to the recipient of the tracking report. Whenever the recipient address and body text are completed, use the Navigation key to enter the body text field and the soft key 'Send' will appear. Press the soft key 'Send' and status about transmitting the SMS will be available to the user. The functionality is illustrated in Figure 252 and in Figure 253.

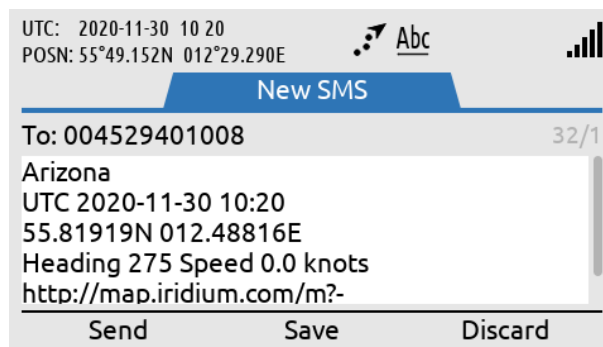

Figure 252: Tracking (Send Position)

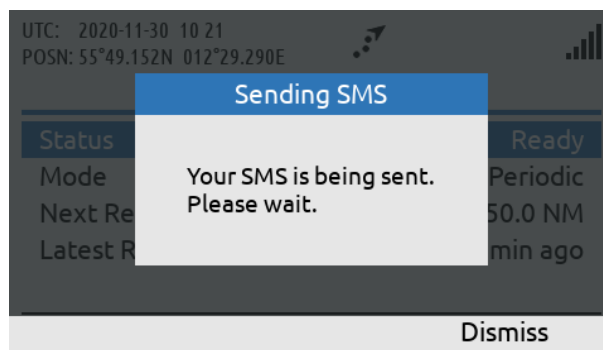

Figure 253: Tracking (Send Position)

NOTE: The LT-3100S GMDSS system can send preformatted tracking reports from the Tracking window without any preceding configuration. Enter the Tracking window (MENU -> System -> Tracking) and press the soft key 'Send' to activate this functionality and select between regular subscriber number and E-mail recipient address.

System Submenus

This section describes and illustrates all the non-GMDSS submenus: Phone, Settings, and System. The submenus are accessed by pressing the MENU button.

Phone

The Phone submenu contains the following entries: Contacts, SMS, and Call History. See Figure 254 for the layout of the Phone submenu.

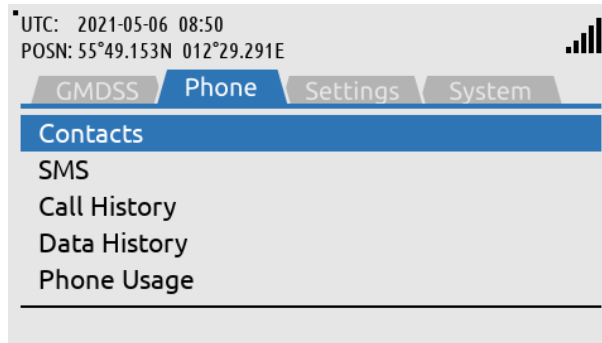

SIP Phones:
MENU -> Phone

Figure 254: Phone submenu

Contacts

The Contacts provides a list of contacts created by the user. Create a new contact by pressing the soft key 'New' and add phone number and name. The phone number is limited to numbers (e.g. 004529401008). It is currently not possible to add E-mail addresses under contacts. The Contact list can contain 100 contacts. Use international number prefix, either '+' or '00XX' in front of the number. A contact can be deleted from the list by pressing the soft key 'Delete' and confirm this.

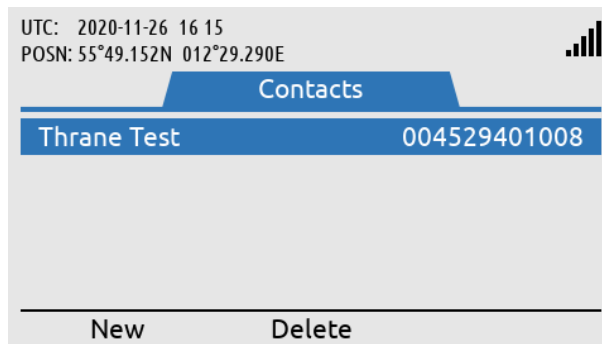

Contacts:
MENU -> Phone ->
Contacts

Figure 255: Phone submenu (Contacts)

NOTE: The user can select an entry from the Contacts (e.g. Thrane Test) and use the Off-hook button to establish a voice call to the contact.

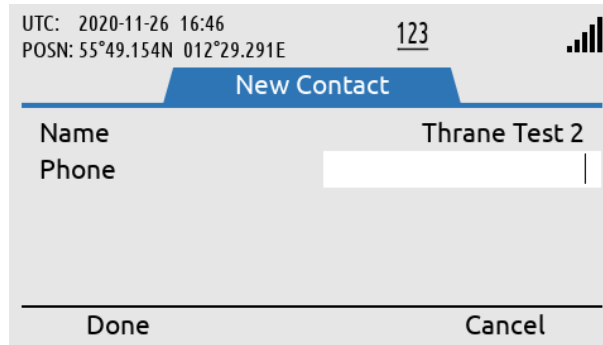

Figure 256: Contacts (New Contact)

SMS

The SMS Service is described and illustrated *General Messaging (SMS)* on page 139.

Call History

The Call History provides a complete list of all voice calls (Safety and General Calling): outgoing, incoming, and missed calls, as illustrated in Figure 257. ‘Unknown’ entries in the Call History will show the soft key ‘New Contact’ to help creating the ‘Unknown’ contacts in the Contact list. Use the soft key ‘Show Missed’ to filter for incoming missed calls.

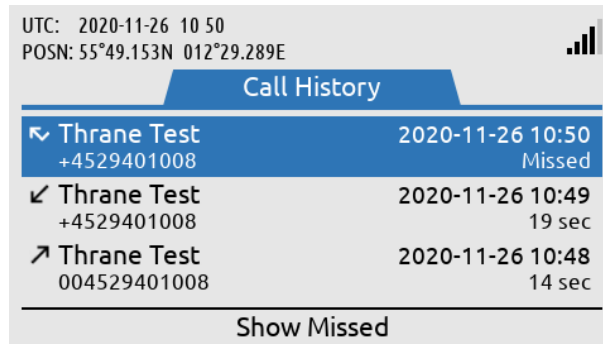

Call History:
MENU -> Phone -> Call
History

Figure 257: Phone submenu (Call History)

Date History:

The Data History provides a complete list of all Modem Data connections (Direct Internet and RUDICS): outgoing and incoming connections will be listed. The Data History is illustrated in Figure 258. The Modem Data is further described in *Data (Modem Data & SMS)* on page 147.

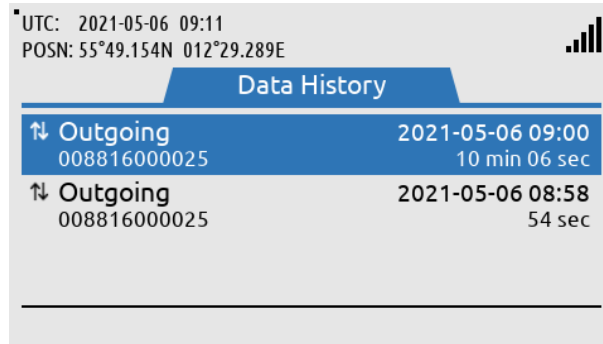

Data History:
MENU -> Phone -> Data History

Figure 258: Phone submenu (Data History)

Phone Usage

The Phone Usage submenu lists Trip and Lifetime terminal usage. To switch between Trip and Lifetime usage, press the softkey titled 'Show Lifetime/Trip'. The lists include Voice totals, SMS totals and Data totals Figure 259 to Figure 262.

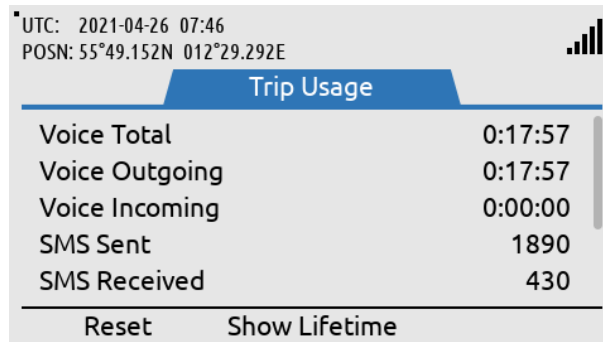

Phone Usage:
MENU -> Phone -> Phone Usage (Trip usage)

Figure 259: Phone submenu (Phone Usage)

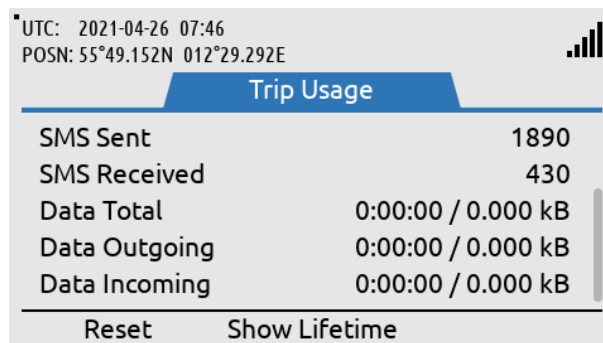



Figure 260: Phone submenu (Phone Usage)

UTC: 2021-04-26 07:46
POSN: 55°49.152N 012°29.292E



Lifetime Usage	
Voice Total	0:17:57
Voice Outgoing	0:17:57
Voice Incoming	0:00:00
SMS Sent	1890
SMS Received	430

Show Trip

Phone Usage:
MENU -> Phone -> Phone
Usage
(Lifetime usage)

Figure 261: Phone submenu (Phone Usage)

UTC: 2021-04-26 07:46
POSN: 55°49.152N 012°29.292E



Lifetime Usage	
SMS Sent	1890
SMS Received	430
Data Total	0:00:00 / 0.000 kB
Data Outgoing	0:00:00 / 0.000 kB
Data Incoming	0:00:00 / 0.000 kB

Show Trip

Figure 262: Phone submenu (Phone Usage)

Settings

The Settings submenu contains the following entries: Audio, Display, Date & Time, and Reset Options. See Figure 263 for the layout of the Settings submenu.

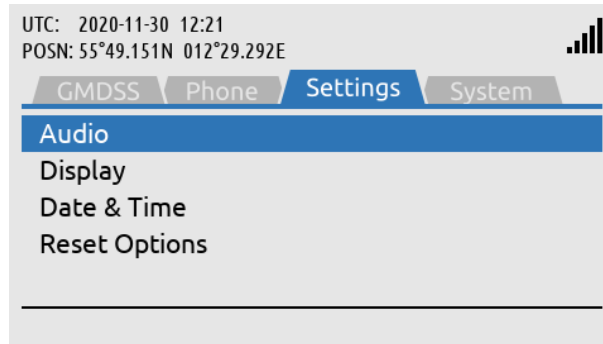

Settings:
MENU -> Settings

Figure 263: Settings submenu

Audio

The Audio settings handles all audio levels and notifications. All audio levels are adjustable in ten levels. Here is a short description of the audio settings and their functionality in the LT-3100S GMDSS system (see Figure 264 for layout):

- *Speaker Volume* adjusts the output level of the LT-3110S Control Unit speaker (located below the DISTRESS button). The Speaker Volume setting is primarily used when operating the system with the LT-3120 Handset placed in LT-3121 Cradle (e.g. making a voice call). The Navigation key (arrows up/down) can be used to control the Speaker Volume output level, when audio is directed to control unit speaker.
- *Handset Volume* adjusts the output level of the LT-3120 Handset speaker (user audio). The user can adjust the Handset Volume during a voice call by using the LT-3120 Handset volume button (up/down) on the side of the handset.
- *Ringer Volume* adjusts the output level of the ringer, when an incoming voice call is presented in the LT-3100S GMDSS system. The Ringer output will be directed to the LT-3120 Handset (integrated ringer speaker on the back side) when placed in the LT-3121 Cradle. Otherwise, the LT-3110S Control Unit speaker is used for indicating an incoming voice call.
- *Key Beep* adjusts the output level of the audio feedback when using the LT-3110S Control Unit keypad. Can be configured to 'Off' if desired.

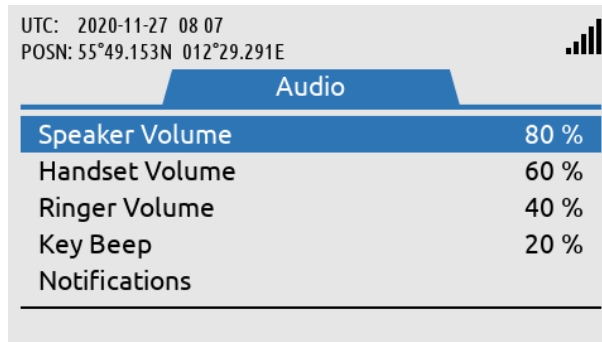

Audio:
MENU -> Settings ->
Audio

Figure 264: Settings submenu (Audio)

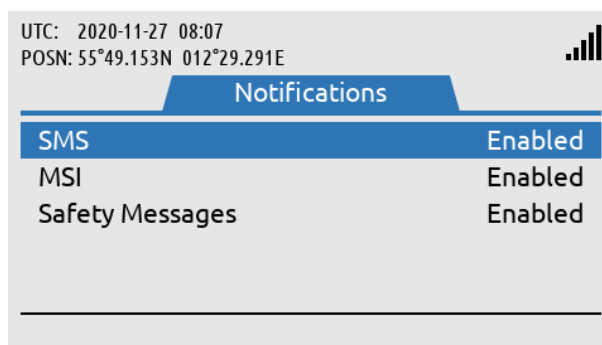

Notifications:
MENU -> Settings ->
Audio -> Notifications

Figure 265: Settings Submenu (Notifications)

NOTE: Audio notifications can be disabled for SMS, MSI, and Safety Messages. For MSI and Safety Messages the audio notification configuration is only valid for priority = Safety. The unread symbol in the status bar will still be shown if audio notifications are disabled.

Display

The Display settings handles all display settings: mode (day or night time) and brightness.

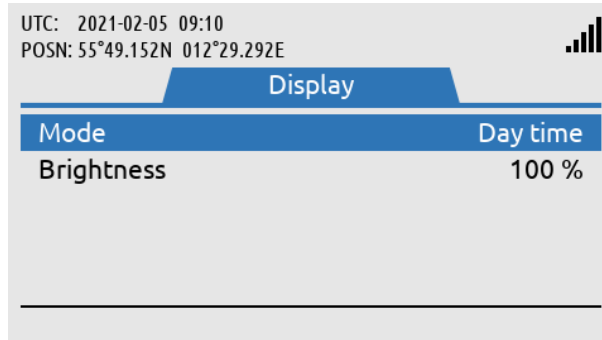

Display:
MENU -> Settings ->
Display

Figure 266: Settings submenu (Display)

NOTE: The display settings can also be configured using the 'Power & DIM' button. Short press on the 'Power & DIM' button changes the brightness, whereas long press on the 'Power & DIM' button changes between day and night time.

Date & Time

Date & Time settings provides the user with a possibility to change formats after completing the Installation Wizard. The LT-3100S GMDSS system support the following date formats: YYYY-MM-DD, D MMM YYYY, DD/MM/YYYY, and MM/DD/YYYY. The time format can be configured to either 24 or 12 hours.

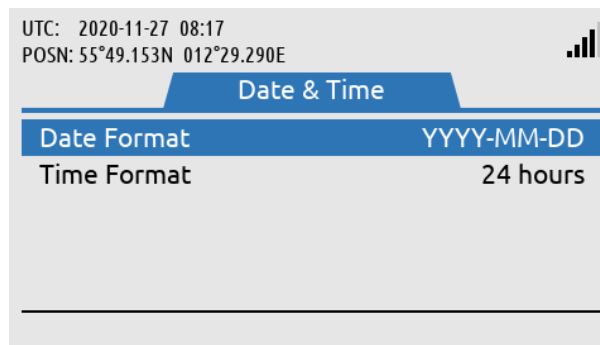

Date & Time:
MENU -> Settings -> Date
& Time

Figure 267: Settings submenu (Date & Time)

NOTE: The Date & Time format will be configured initially when completing the Installation Wizard. The Installation Wizard is described and illustrated in *Installation Wizard* on page 61.

Reset Options

The Reset Options handles the reset of the following user records and configurations: Call History, SMS, and Web Server Authentication. Use the soft key 'Execute' or the 'ENTER' button to activate the reset, when the correct Reset Option has been selected by the 'Navigation' key (arrow up/down). The user of the LT-3100S GMDSS system will have to confirm the reset, see Figure 268 and Figure 269.

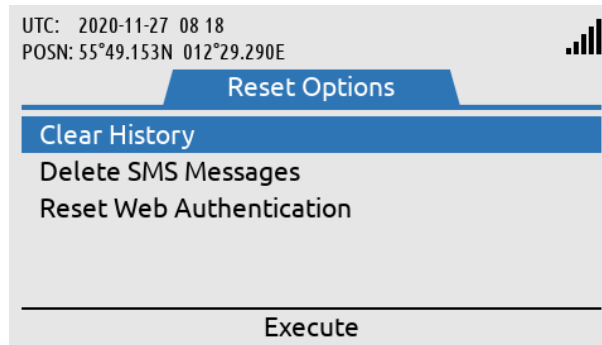

Reset Options:
MENU -> Settings ->
Reset Options

Figure 268: Settings submenu (Reset Options)

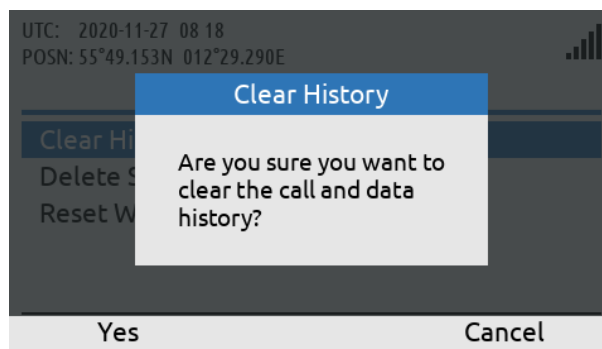
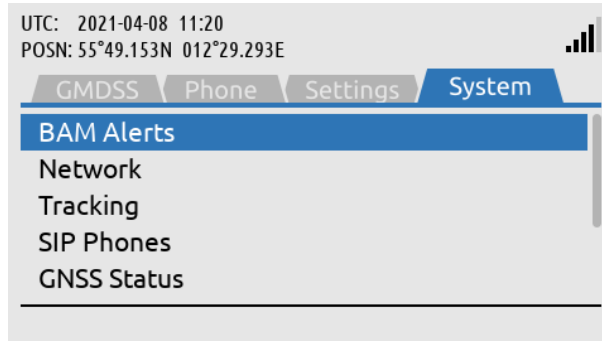

Figure 269: Settings submenu (Reset Options)

NOTE: The reset of the web server authentication can be managed from the Settings submenu for the user to get access to the web server in the situation, where the user cannot find the changed password. To avoid unwanted access to the web server via the network interface, it is highly recommended to change the web server authentication password at any time. The web server authentication is described and illustrated in *Authentication* on page 183.

System

The System submenu contains the following entries: BAM Alert, Network, Tracking, SIP Phones, GNSS Status, Subscription, System Info, and Power Supply. See Figure 270 and Figure 271 for the layout of the System submenu.



System:
MENU -> System
(upper view)

Figure 270: System submenu

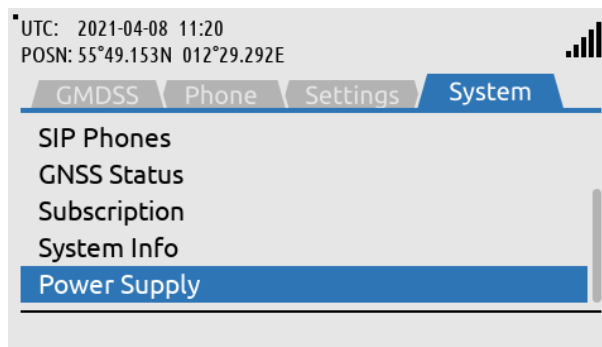

System:
MENU -> System
(lower view)

Figure 271: System submenu

BAM Alerts

BAM Alerts provides an overview of the active alerts in the LT-3100S GMDSS system. The Bridge Alert Management (BAM) is described and illustrated in detail in *Bridge Alert Management (BAM)* on page 169.

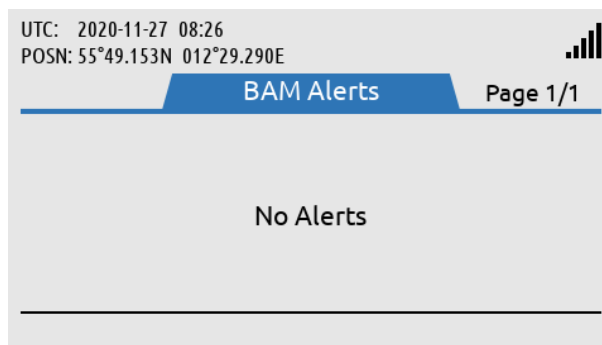

BAM Alerts:
MENU -> System -> BAM
Alerts (or long press on
the MENU button)

Figure 272: System submenu (BAM Alerts)

NOTE: The BAM Alerts list illustrated in Figure 272 should under normal conditions be empty (No Alerts). Make sure to read the alerts carefully and take appropriate action.

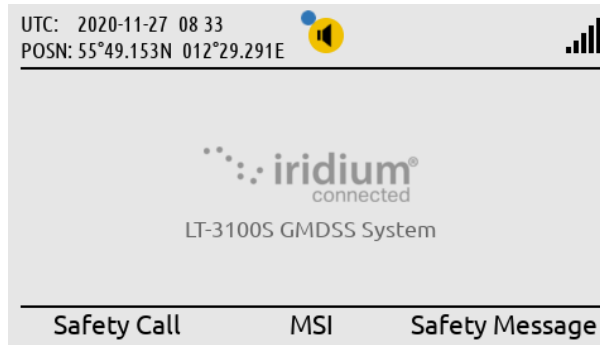

BAM alert shown in the status bar (active warning). The blue dot indicates a change in the BAM Alerts, after the user has last been in the list.

Figure 273: BAM Alerts (1 of 4)

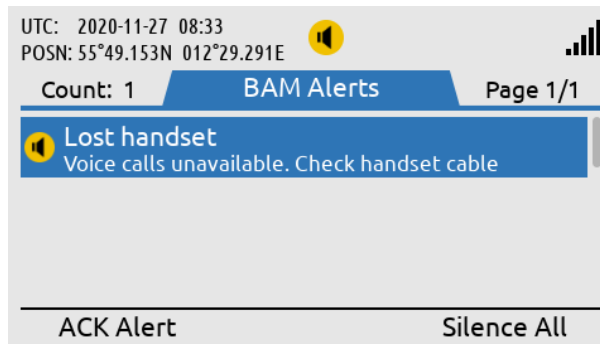

Long press on the MENU button to access the BAM Alerts (Lost Handset).

Figure 274: BAM Alerts (2 of 4)

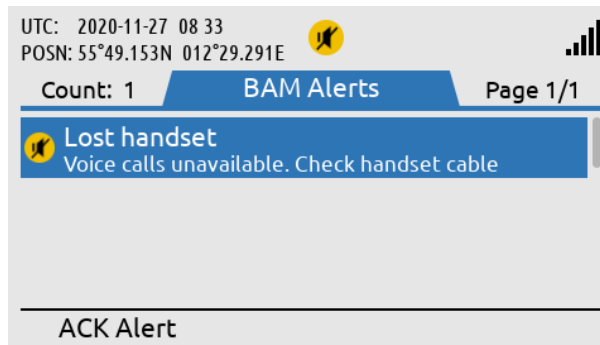

Press the soft key 'Silence All' to mute the audible alarm for 30 seconds.

Figure 275: BAM Alerts (3 of 4)

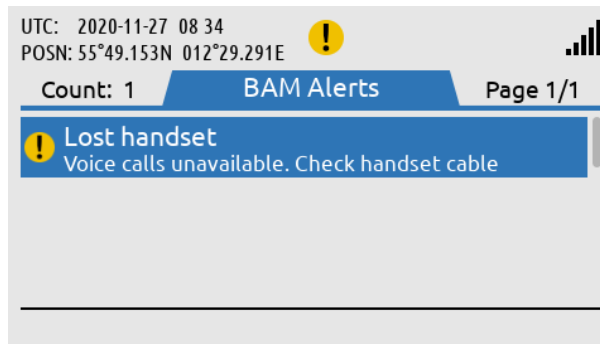

Press the soft key 'ACK Alert' acknowledge the BAM alert.

Figure 276: BAM Alerts (4 of 4)

Network

The Network provides an overview for the user of the LT-3100S GMDSS system of the IP network configuration and setup. The LT-3100S GMDSS system can be configured to: DHCP Client, DHCP Server, and Static IP address. The link status will provide the user with information about and whether an IP connection is established to the LT-3110S Control Unit. The IP address of the LT-3110S Control Unit is provided under the IP Address parameter illustrated in Figure 277.

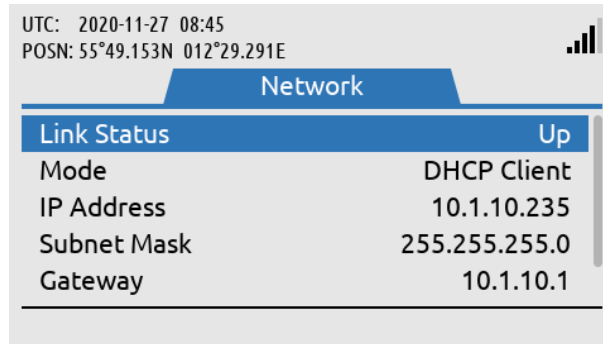

Network:
MENU -> System ->
Network

Figure 277: System submenu (Network)

NOTE: Use the IP Address to access the built-in web server. Instructions to access the built-in web server is provided in *Accessing the built-in web server* on page 178.

Tracking

The Tracking functionality is described and illustrated in *Tracking* on page 150.

SIP Phones

The SIP Phones functionality is described and illustrated in *External SIP Phones* on page 144.

GNSS Status

The GNSS Status provides an overview for the user of the LT-3100S GMDSS system built-in GNSS receiver. The GNSS receiver can be configured from the web server, see *GNSS, BAM and MSI* on page 197.

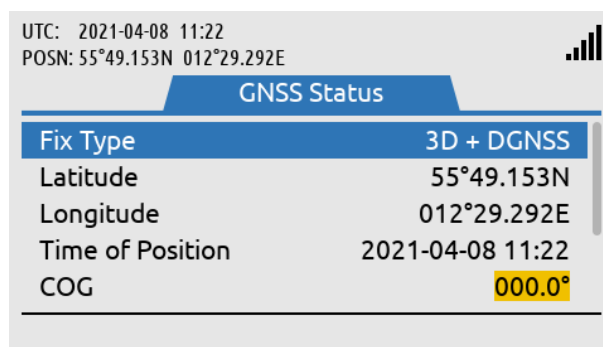

Position Status:
MENU -> System -> Position
Status
(upper view)

Figure 278: System submenu (Position Status)

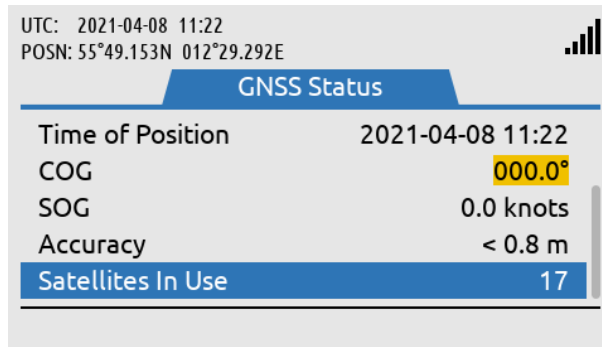

Position Status:
MENU -> System -> Position
Status
(lower view)

Figure 279: System submenu (Position Status)

NOTE: The GNSS Status window shows the GNSS receiver status (in Automatic GNSS mode). The Manual Position input will not be shown in the GNSS Status window. The GNSS Status (Automatic GNSS) integrity states are further described and illustrated in *App. G - GNSS Receiver Integrity States (Automatic GNSS)* on page 223.

Subscription

The LT-3100S GMDSS system supports both General Calling (priority = Routine) and General Messaging (priority = Routine), also mentioned as Voice Call and SMS. The Voice and SMS Service must be activated with the Iridium GMDSS Service Provider (SP) in order to be available as a service for the LT-3100S GMDSS system. The LT-3100S GMDSS System is also supporting the Iridium 2.4 kbps Modem Data (Direct Internet and RUDICS), for more information see *Data* on page 147. The Subscription status will provide the user with information whether the Voice, SMS and Data Services are activated or not.

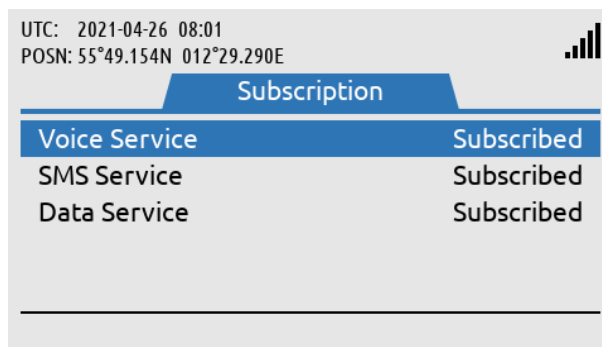

Subscription:
MENU -> System ->
Subscription

Figure 280: System submenu (Subscription)

NOTE: The Voice and SMS Service must be activated with the Iridium GMDSS Service Provider (SP). in order to be available as a service for the LT-3100S GMDSS system.

System Info

The System Info provides details about the LT-3100S GMDSS system software and hardware. In addition, the following numbers are available: MSISDN (~satellite phone number), IMEI (~mobile equipment number), and ICCID (~SIM card number). The System Info is illustrated in Figure 281 and in Figure 282.

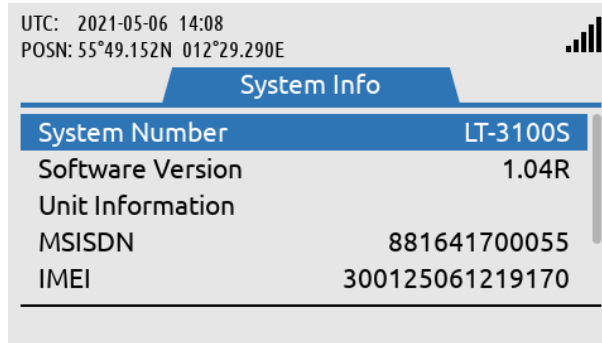

System Info:
MENU -> System -> System Info
(upper view)

Figure 281: System Submenu (System Info)

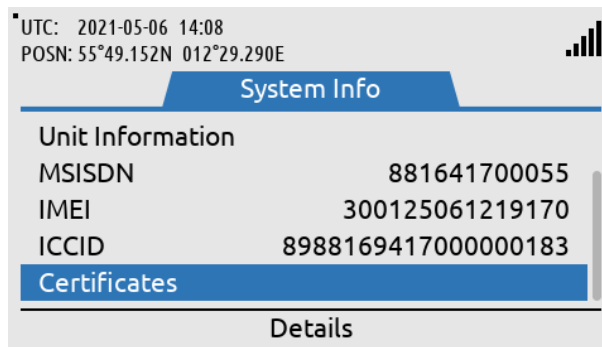

System Info:
MENU -> System -> System Info
(lower view)

Figure 282: System submenu (System Info)

To review information about configured units enter the Unit Information submenu. All configured units in the system will be displayed. The Unit information submenu is seen on Figure 283. By pressing the 'Details' Soft key, more information is available, see Figure 283 to Figure 286.

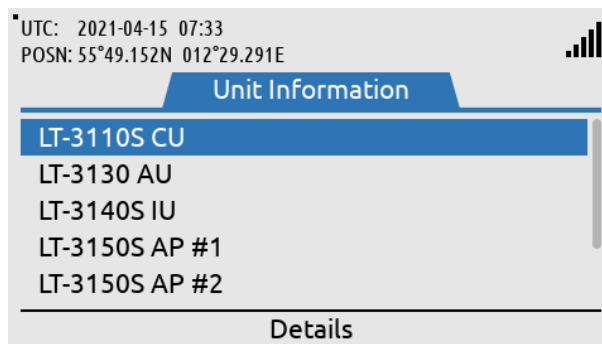

Unit Info:
MENU -> System -> System Info-> Unit Info
(top view)

Figure 283: System submenu (System Info-> Unit Info)

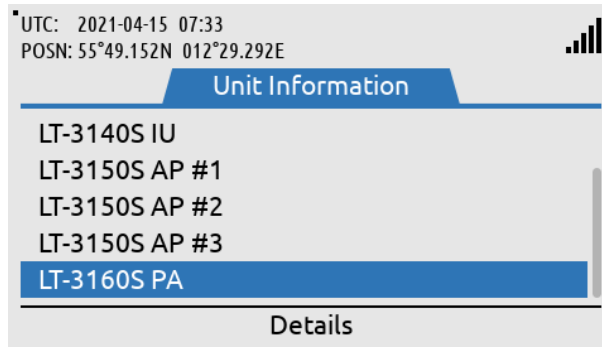

Unit Info:
 MENU -> System -> System
 Info-> Unit Info
 (lower view)

Figure 284: System submenu (System Info-> Unit Info)

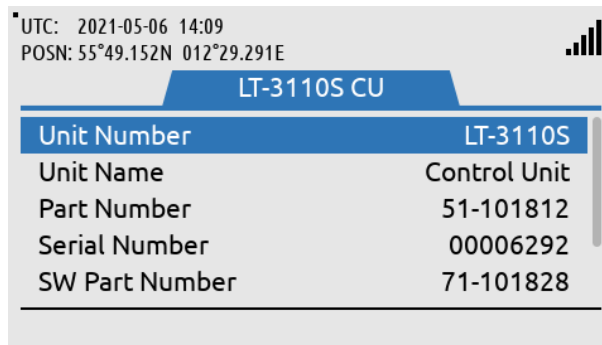

Information about the
 LT-3110S CU
 (Top view)

Figure 285: System submenu (Unit Info-> LT-3110S CU)

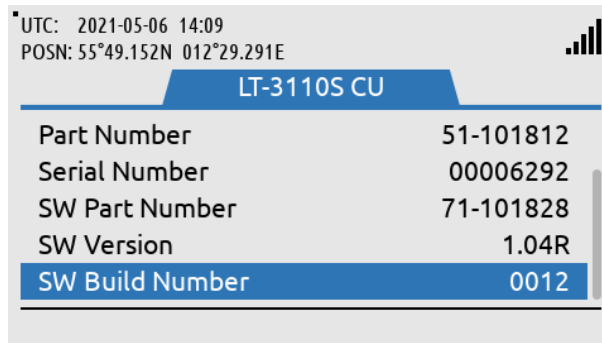

Information about the
 LT-3110S CU
 (Bottom view)

Figure 286: System submenu (Unit Info -> LT-3110S CU)

NOTE: The LT-3140S IU will only be present in the Unit Info submenu if a LT-3140S Interface Unit is configured for the system.

Certificates

LT-3100S GMDSS System certificates can be found by entering the ‘Certificates’ submenu. This is seen on Figure 287.

The screenshot shows a terminal window with the following content:

```

UTC: 2021-04-08 11:23
POSN: 55°49.153N 012°29.292E
    
```

At the top of the main display area, the word "Certificates" is centered in a blue header bar. Below this, a table lists certificate information:

RED	DK-RED001541 i01
FCC	2AP9E-10193100S
ISED	24065-10193100S
MED B	MEDB00006GB
MED D	MEDD000021J

System Info:
 MENU -> System -> System
 Info-> Certificates

Figure 287: System submenu (System Info-> Certificates)

Power Supply

The Power Supply provides details about the DC input voltage on the LT-3110S Control Unit, LT-3130 Antenna Unit and LT-3140S IU.

The screenshot shows a mobile device interface with the following information:

- UTC: 2021-04-08 12:44
- POSN: 55°49.152N 012°29.292E
- Signal strength indicator (four bars)
- Section header: Power Supply
- Table of input power values:

Unit	Input Power
CU	23.9 VDC
AU	23.7 VDC
IU	24.0 VDC

Power Supply:
MENU -> System -> Power
Supply

Figure 288: System submenu (Power Supply)

NOTE: IU Input Power is only present if an LT 3140S Interface Unit has been configured for the system.

Bridge Alert Management (BAM)

Bridge Alert Management (BAM) is the IMO defined overall concept for the harmonized management, distribution, handling and presentation of alerts on the bridge, to enable the bridge team to devote full attention to the safe operation of the ship and to immediately identify any alert situation requiring action to maintain the safe operation of the ship. The LT-3110S GMDSS system implements the BAM concept in compliance with the relevant standards (IEC 62923-1 and IEC 62923-2 Bridge Alert Management).

BAM status

The LT-3100S GMDSS system continuously monitor for fault conditions (e.g. no satellite signal) and other events (e.g. received distress communication) that requires the attention of the bridge team and raises relevant alerts. The user can, at any time, check for the presence of alerts without performing any action: if there are one or more active alerts, a BAM icon representing the alert with the highest priority is shown in the status bar (see Figure 289). The exact icon shown depends on the priority and state of the alert with the highest priority (see Table 42 on page 170). It is not possible to hide or suppress the BAM icon in the status bar.

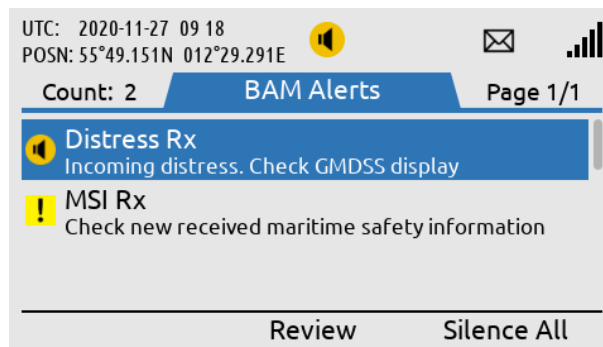

Figure 289: LT-3110S Control Unit (BAM status)

Alert list

Once the user has become aware an alert has been raised, the user can navigate to the alert list (MENU -> System -> BAM Alerts) to find further information about the alert conditions.

NOTE: For quick access to the alert list, long press (≥ 1 s) the MENU button at any time.



If MSI or a Safety Message is responsible for the BAM Alert, pressing the soft key 'Review' will direct the user to the specific MSI or Safety Message.

Figure 290: LT-3110S Control Unit (BAM Alert list)

See *App. B - Bridge Alert Management (BAM)* on page 207 for the full list of alerts that can be raised by the LT-3100S GMDSS system.

Alert priority and state

The *priority* of an alert indicates its severity. The BAM concept defines 4 priorities: Emergency Alarm, Alarm, Warning and Caution. The LT-3100S GMSDS system can raise alerts of the following priorities:

- **Warning:** Condition requiring immediate attention, but no immediate action by the bridge team. Warnings are presented for precautionary reasons to make the bridge team aware of changed conditions which are not immediately hazardous but may become so if no action is taken.
- **Caution:** Lowest priority of an alert. Awareness of a condition which does not warrant an alarm or warning condition, but still requires attention out of the ordinary consideration of the situation or of given information.

The shape and color of the BAM icon indicates the priority of the alert and the symbol inside indicates its state as per Table 42 below.







BAM Alert Icons, Priority and Stat				
Priority	Icon	State	Condition	Audible signal
Warning		Active – unacknowledged	Alert condition present. Alert not acknowledged.	Yes
		Active – silenced	Alert condition present. Alert not acknowledged, but audible signal has been silenced by the operator.	No
		Active – acknowledged	Alert condition present. Alert acknowledged by the operator.	No
		Active – responsibility transferred	Alert condition present. A function of the BAM compliant equipment with additional system knowledge has taken over.	No
		Rectified – unacknowledged	Alert condition rectified. Alert still unacknowledged.	No
	None	Normal	No alert condition present.	No
Caution		Active	Alert condition present.	No
	None	Normal	No alert condition present.	No

Table 42: BAM Alert Icons, Priority and State

Temporary silence

Active unacknowledged alerts cause a short but periodically repeated audible signal. To temporarily silence all alerts (and thus the audible signal), press the “Silence All” soft key. The temporary silence period expires after 30 s, after which active silenced alerts become active unacknowledged alerts again, causing the audible signal to resume.

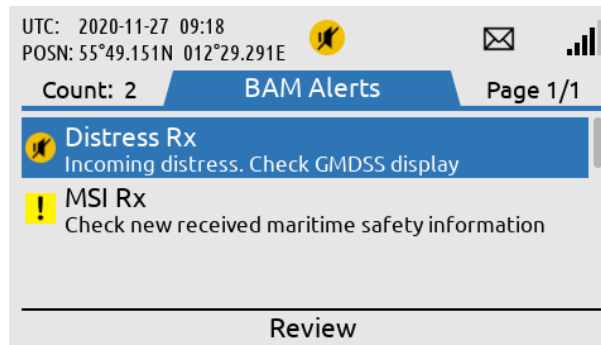

Figure 291: LT-3110S Control Unit (BAM Alerts)

NOTE: Active unacknowledged alerts cause a short but periodically repeated audible signal, which can be temporarily silenced (for 30 s) by pressing the soft key ‘Silence All’. This temporary silence has been illustrated in Figure 291. In this example, the active unacknowledged BAM alert can be cleared when the distress alert relay message has been read in the MSI Messages (e.g. by pressing the soft key ‘Review’).

Alert acknowledgement

Alerts of priority warning must be acknowledged by the user. To acknowledge an alert, press the “ACK Alert” soft key.

Some alerts cannot be acknowledged by the user, in which case the “ACK Alert” soft key will be absent. This applies to alerts for which the alert text and alert description is not enough for decision support.

When an alert is both acknowledged and rectified it disappears from the alert list. Cautions cannot be acknowledged and thus disappear as soon as they are rectified.

Aggregation

The BAM concept defines aggregation as a means for an alert source to combine multiple individual alerts of the same kind into a single aggregated header alert to reduce the risk that the number of individual alerts obscures the display of equally important additional alerts, for example due to the active alert list length exceeding the maximum display capability of the alert source UI.

NOTE: The LT-3100S GMDSS system currently does not define any alerts that can be aggregated.

Responsibility transfer

The BAM concept defines the Central Alert Management (CAM) system as equipment used for centralizing management, handling and presentation of alerts on the bridge. A CAM system may be standalone or combined with other equipment, for example in the case of an Integrated Navigation System (INS).

A CAM system connects to multiple alert sources (such as the LT-3100S GMDSS system) in order to manage and present their alerts on the CAM UI. An alert will thus be presented in the alert list of both the alert source and the CAM system.

To reduce the number of high-priority audible alerts for one situation that requires attention, if the CAM system has additional knowledge regarding an alert situation, which caused the LT-3100S GMDSS system to raise an alert, the CAM system may apply responsibility transfer and raising a new alert with, if practicable, a lower priority.

NOTE: Alerts of priority caution are not audible and therefore cannot have their responsibility transferred.

NOTE: The LT-3100S GMDSS will reject the request for responsibility transfer if no HBT sentence (indicating good status) has been received from the CAM system within the last 90 s.

Time synchronization

The LT-3100S GMDSS system can supply the UTC time of alert state changes to the CAM system due to the built-in GNSS receiver.

NOTE: If the alert state change occurs before the built-in GNSS receiver has obtained the UTC time or in case of GNSS receiver malfunctioning, the LT-3100S GMDSS system will not supply the UTC time.

Serial Interface (RS-422)

GNSS sentences

The LT-3100S GMDSS system support outputting of GNSS sentences encoded as NMEA 0183 via an RS-422 interface from the LT-3100S GMDSS system, as illustrated in Figure 292. The LT-3100S GMDSS system has a built-in GNSS receiver in the LT-3130 Antenna Unit.



Figure 292: GNSS sentences

Table 43 presents the supported GNSS sentences by the LT-3100S GMDSS system. The configuration of the GNSS sentences are illustrated and described in *GNSS, BAM and MSI* on page 197.

GNSS Sentences			
Sentence	Baud Rate		
	4.800	9.600	38.400
DTM	X	X	X
GGA	X	X	X
GLL	X	X	X
GSA	X	X	X
GSV	-	X	X
RMC	X	X	X
VTG	X	X	X
ZDA	X	X	X

Table 43: GNSS sentences

IMPORTANT: The GNSS receiver of the LT-3100S GMDSS system is not certified according to IMO performance standards for GNSS receivers. The LT-3100S GMDSS system shall not be connected to equipment where the GNSS receiver interface must be certified.

The GNSS sentences and decoding of these are further documented in *App. D - GNSS sentences* on page 217.

BAM sentences

The LT-3100S GMDSS system support connection to an external Central Alert Management (CAM) system via an RS-422 interface from the LT-3100S GMDSS system, as illustrated in Figure 293. The CAM system can receive BAM information (e.g. warning and cautions) from the bridge equipment and centralize and present this information to the user, which can be acknowledged to the BAM equipment (here the LT-3100S GMDSS system).

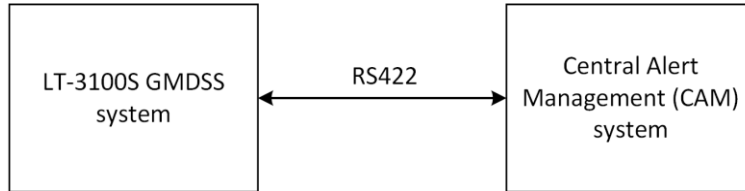

Figure 293: CAM/BAM system

Table 44 presents the supported BAM sentences by the LT-3100S GMDSS system. The configuration of the BAM sentences are illustrated and described in *GNSS, BAM and MSI* on page 197.

Sentences Received by SES		
Sentence	Name	Comment
ACN	Alert Command	Alert command for instance acknowledge
HBT	Heartbeat	Support reliable alert related communication
Sentences Transmitted by SES		
Sentence	Name	Comment
ARC, ALC, ALF	Alert information	

Table 44: BAM sentences

NOTE: The encoding of BAM sentences is defined in IEC 61162-1 (Edition 5.0, 2016-08), the encoding is similar to NMEA 0183.

The BAM sentences and decoding of these are further documented in App. E - BAM sentences on page 219.

MSI sentences

The LT-3100S GMDSS system supports connection to an external ECDIS system via an RS-422 interface from the LT-3100S GMDSS system, as illustrated in Figure 294. The MSI sentences are transmitted from the LT-3100S GMDSS system as ‘information only’. The MSI messages transmitted from the Iridium GMDSS System (IGS) must always be read via the LT-3110S Control Unit UI display (MSI messages cannot be marked/acknowledged via the external ECDIS system receiving these MSI messages).

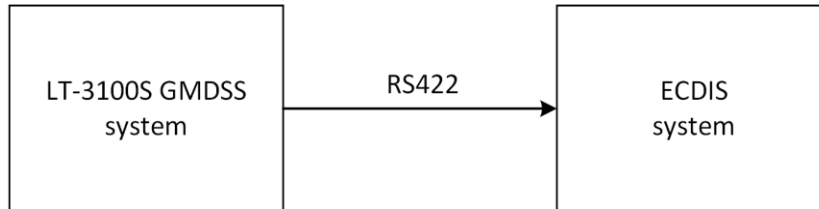

Figure 294: MSI sentences

Table 45 presents the supported MSI sentences by the LT-3100S GMDSS system. The configuration of the MSI sentences are illustrated and described in *GNSS, BAM and MSI* on page 197.

Sentences Transmitted by the SES		
Sentence	Name	Comment
SM1, SM2, SM3, SM4, SMB, SMV	Maritime Safety Information (MSI)	

Table 45: MSI sentences

NOTE: The encoding of MSI sentences is defined in the IEC-61097-16 (Edition 1.0 2019-07) standard, the encoding is similar to NMEA 0183.

The MSI sentences and decoding of these are further documented in *APP. F - MSI sentences* on page 221.

GMDSS Printers

The LT-3100S GMDSS system support connection of an external GMDSS printer. The GMDSS printer must be connected via the LT-3140S interface Unit and use the proprietary LT-3160S Printer Adapter from Lars Thrane A/S. The LT-3160S Printer Adapter is connecting to the GMDSS printer via a Centronics interface, 36 pins (IEEE Std 1284-2000, 1284-B receptacle connector). The LT-3160S Printer Adapter is connected to the LT-3140S Interface Unit, using the interface marked 'Printer'. The LT-3160S Printer Adapter is powered from the LT-3140S Interface Unit.

The LT-3100S GMDSS system can print the International Reference Alphabet (IRA) character set (also known as IA5 or T.50).

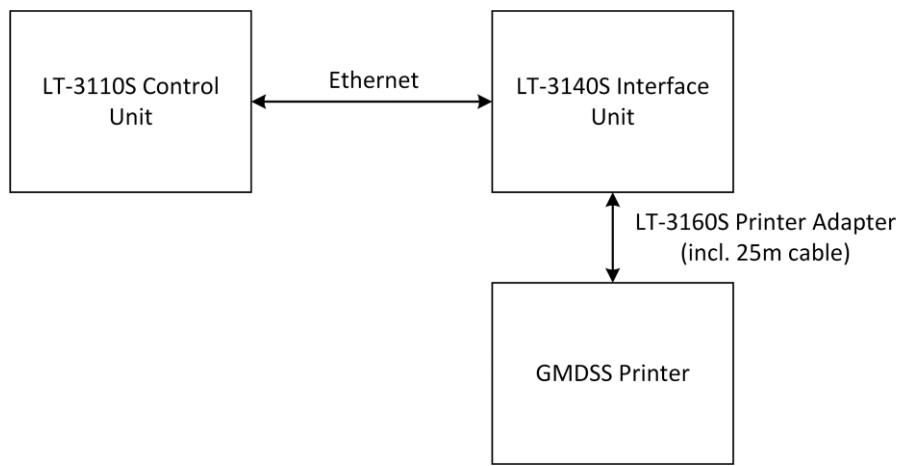

Figure 295: Connect a GMDSS Printer

The GMDSS printer will be detected when running the Installation Wizard, see *Installation Wizard* on page 61. If the GMDSS printer is added after completion of the Installation Wizard, then the Service Wizard will detect the GMDSS printer and complete the setup.

The LT-3100S GMDSS system is supporting the GMDSS printers listed in Table 46.

GMDSS Printers	
Manufacturer	Model No.
Furuno	PP-520
JRC	NKG-900
Cobham / SAILOR	H1252B/TT-3608A

Table 46: GMDSS Printers Supported

NOTE: The LT-3100S GMDSS system will generate a BAM alert, if the GMDSS printer is running out of paper, see BAM alerts in *App. B - Bridge Alert Management (BAM)* on page 207.

NOTE: Accordingly, to the new GMDSS standard IEC 61097-16, it is no longer a requirement to have a GMDSS printer as part of the GMDSS Satcom installation.

Web server

The LT-3110S Control Unit has a built-in webserver, which can be accessed from the Ethernet (RJ45) interface from the back side of the control unit. A PC must be connected to the control unit, either directly by connecting an Ethernet cable between a PC and the LT-3110S Control Unit, or by connecting the LT-3110S Control Unit to a Local Area Network (LAN), to where the PC is connected.

NOTE: The IP address allocated to the LT-3110S Control Unit, is shown in the GUI (Menu -> System -> Network: IP Address).

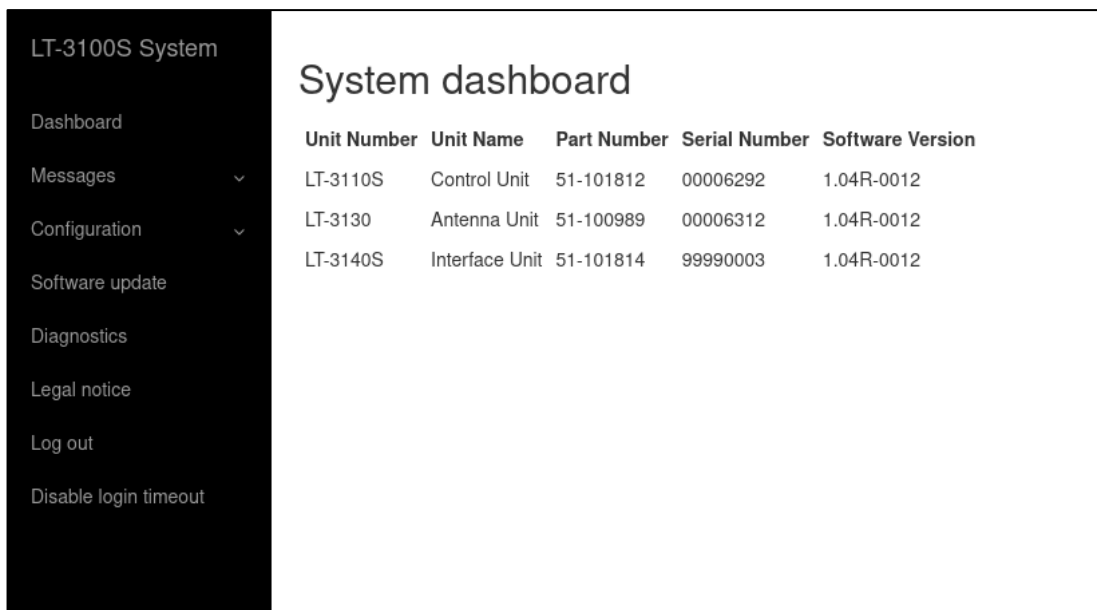

Figure 296: Web server (System dashboard)

The functionality of all web pages is described in further detail in the following sections. Some of the sections will refer to other sections in this User & Installation Manual, e.g. hardware interfaces.

NOTE: All web pages functionality will be described in detail for the LT-3100S GMDSS system. It is the intention that the web pages should be used during the installation and configuration of the system. During normal operation of the system, it shouldn't be necessary to access the web pages.

Accessing the built-in web server

To access the built-in web server of the LT-3100S GMDSS system, please complete the following steps:

1. Connect the LT-3110S Control Unit directly to a PC using an Ethernet cable, or connect the LT-3110S Control Unit to a Local Area Network (LAN), where a PC is connected. If the LT-3140S Interface Unit is connected to the LT-3110S Control Unit, then use one of the spare Ethernet ports on the LT-3140S Interface Unit, which will behave as a Layer 2 Ethernet (network) Switch.
2. Identify the IP address that is assigned to the LT-3110S Control Unit. The IP address can be read out from the display (MENU -> System -> Network: IP Address). The IP address is valid if the 'Link Status' is showing 'Up'. The IP address is assigned dynamically by a DHCP server.
3. From the PC, start a browser (e.g. Microsoft Edge, Explorer, Chrome, etc.) and type in the IP address, which was identified in the LT-3110S Control Unit (e.g. 169.254.1.1).
4. The browser might show you a warning about an invalid web server certificate, as illustrated in Figure 297. Make sure, that you have typed in the correct IP address.
5. Press 'Details' and you will be presented for an extended page view (including a link), which will direct you to the LT-3100S GMDSS system dashboard 'Go on to the webpage (Not recommended)'.
6. You will now see the LT-3100S GMDSS system dashboard.

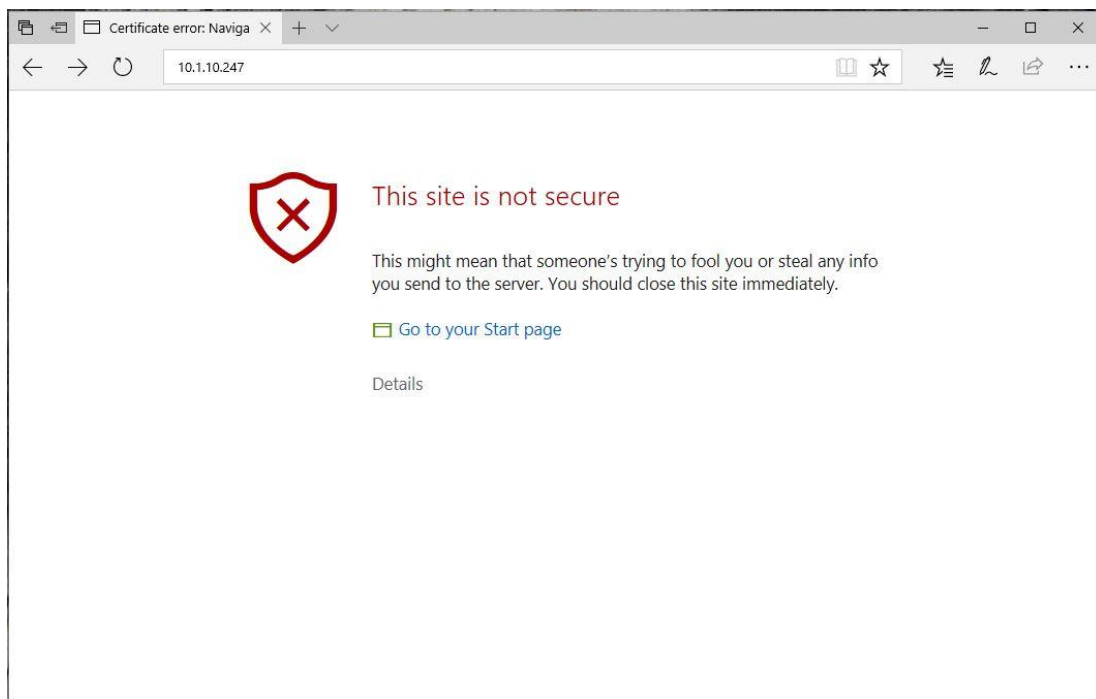
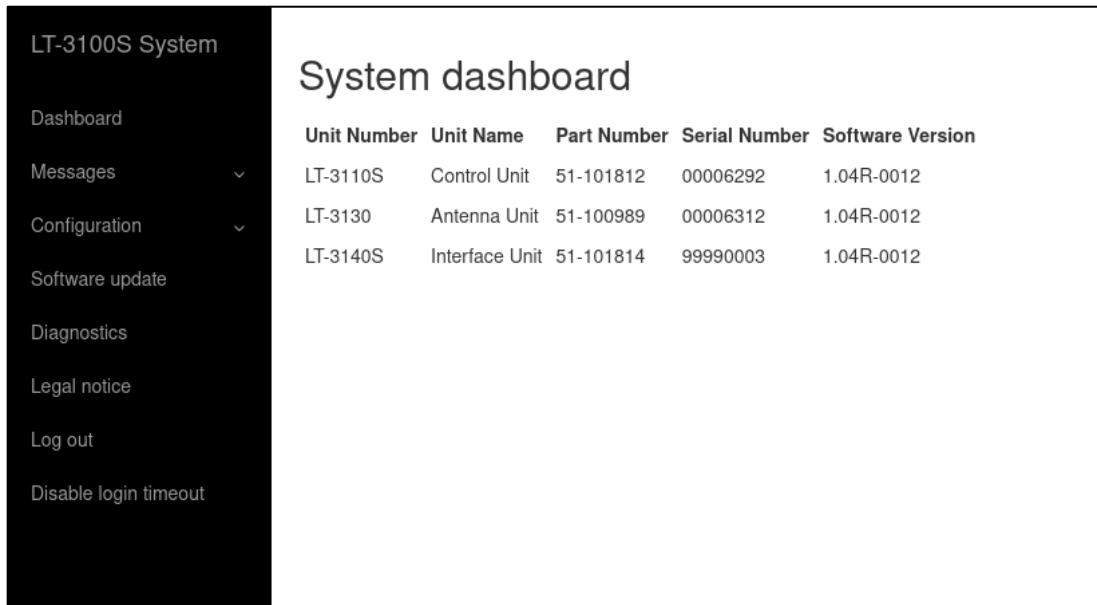

Figure 297: Accessing the built-in web server ("This site is not secure").

Dashboard

The dashboard is showing details about the main units, which forms the satcom system: the LT-3110S Control Unit, LT-3130 Antenna Unit, LT-3140S Interface Unit, LT-3150S Alarm Panel, and LT-3160S Printer Adapter. If the units are connected correctly to the control unit, then the units will be visible on the web server dashboard, as illustrated in Figure 298. Otherwise, only the control unit will be visible. For each unit, the following information will be available: unit number, unit name, unit part number, unit serial number, and software version. The antenna unit, interface unit, alarm panels, and printer adapter will automatically be updated with the software installed in the control unit.



The screenshot shows the 'System dashboard' for the LT-3100S system. On the left is a dark sidebar with navigation options: Dashboard, Messages, Configuration, Software update, Diagnostics, Legal notice, Log out, and Disable login timeout. The main content area displays a table with the following data:

Unit Number	Unit Name	Part Number	Serial Number	Software Version
LT-3110S	Control Unit	51-101812	00006292	1.04R-0012
LT-3130	Antenna Unit	51-100989	00006312	1.04R-0012
LT-3140S	Interface Unit	51-101814	99990003	1.04R-0012

Figure 298: Web server (System dashboard)

The web server has the following webpages:

- Dashboard
- Messages (MSI)
- Configuration (*contains subpages*)
- Software update
- Diagnostics
- Legal notice
- Log out
- Disable login timeout

Messages (MSI)

The LT-3100S GMDSS system is supporting Maritime Safety Information (MSI), which is described in *Maritime Safety Information (MSI)* on page 88. The LT-3100S GMDSS system is offering ‘read-only’ access of the MSI messages via the web server as illustrated in Figure 299 and Figure 300. By clicking on the individual MSI messages the message will expand and the user can read the content of the message.

No.	Priority	Class	Area	Cancel By	Advisory ID
30	SAFETY	NAV	1	2021-06-08 02:19	6087747f_2f8d
29	SAFETY	NAV	1	2021-04-27 03:16	608773f0_b833
28	SAFETY	MET	1	2021-04-27 09:25	60872fbd_21cd
27	URGENCY	SAR	CIRC	2021-04-26 13:47	6086b612_106f
26	SAFETY	MET	1	2021-04-26 21:25	60868708_9818
25	SAFETY	NAV	1	2021-05-02 18:00	60863892_7980
24	SAFETY	MET	1	2021-04-26 09:25	6085de37_e389
23	SAFETY	NAV	1	2021-06-06 10:01	60853dd3_fb3e
22	SAFETY	NAV	1	2021-04-25 11:00	60853d9c_7d84
21	SAFETY	NAV	1	2021-06-06 09:57	60853c92_2576
20	SAFETY	MET	1	2021-04-25 21:25	6085357a_7c03
19	SAFETY	MET	1	2021-04-25 09:25	60848cb6_7a93
18	SAFETY	MET	1	2021-04-24 21:25	6083e3f7_fb61
17	SAFETY	MET	1	2021-04-24 09:25	60833b3c_9bb1

Figure 299: Web server (Maritime Safety Information (MSI))

NOTE: The MSI messages ‘read-only’ access on the web server is for information only and will list all received MSI messages. The user of the LT-3100S GMDSS system cannot see whether the MSI messages has been read from the LT-3110S Control Unit display or not. It is a requirement that the user of the LT-3100S GMDSS system reads and understand all MSI messages received from the Iridium GMDSS System. The Bridge Alert Management (BAM) supported in the LT-3100S GMDSS system will clearly show (e.g. in the status bar), if there are unread MSI messages, which must be read.

It is possible to create a MSI login to the web server, which only gives permissions to read MSI messages. The MSI login access is described in *Authentication* on page 183.

LT-3100S System

Dashboard

Messages ^

MSI

Configuration v

Software update

Diagnostics

Legal notice

Log out

Disable login timeout

GMDSS

Maritime Safety Information

No.	Priority	Class	Area	Cancel By	Advisory ID
30	SAFETY	NAV	1	2021-06-08 02:19	6087747f_2f8d

```

----- MSI MESSAGE 30 BEGIN -----
TYPE      : NAVIGATIONAL WARNING OR BULLETIN
PRIORITY  : SAFETY
CREATED   : 2021-04-27 02:19 UTC
RECEIVED  : 2021-04-27 05:40 UTC
CANCEL BY : 2021-06-08 02:19 UTC
TARGET AREA : NAVAREA 1
ADVISORY ID : 6087747F_2F8D
BODY LENGTH : 471 CHARACTERS
----- MESSAGE BODY -----
NAVAREA I 054/21
NORTH SEA, UK AND NORWEGIAN SECTORS.
Shetland Islands North-eastwards.
Chart GB 2182D (INT 1040).
1. Seismic survey in progress by M/V SW Amundsen towing 12 x 8000 metre cables within area bounded by 62-02.1N 000-11.1E,
62-03.2N 001-29.1E, 61-54.9N 001-25.9E, 61-55.0N 004-11.5E, 60-39.1N 004-08.6E, 60-37.7N 000-36.6E, 61-34.0N 000-32.5E
and 61-33.6N 000-13.7E.
Wide berth requested. M/V Sanco Scorpio and M/V Tess in attendance.
2. Cancel NAV I 052.
----- MSI MESSAGE 30 END -----
                
```

29	SAFETY	NAV	1	2021-04-27 03:16	608773f0_b833
28	SAFETY	MET	1	2021-04-27 09:25	60872fbd_21cd
27	URGENCY	SAR	CIRC	2021-04-26 13:47	6086b612_106f

Figure 300: Web server (Maritime Safety Information (MSI))

Configuration

The LT-3100S GMDSS system is initially configured and fully operational after the Installation Wizard has been completed. The Installation Wizard is described and illustrated in *Installation Wizard* on page 61. Additionally, the GMDSS settings can be configured via the GMDSS submenu, as described in *GMDSS Submenu* on page 102. In this section there will be a description of system settings, which is not covered by the Installation Wizard and the LT-3110S Control Unit display menu layout.

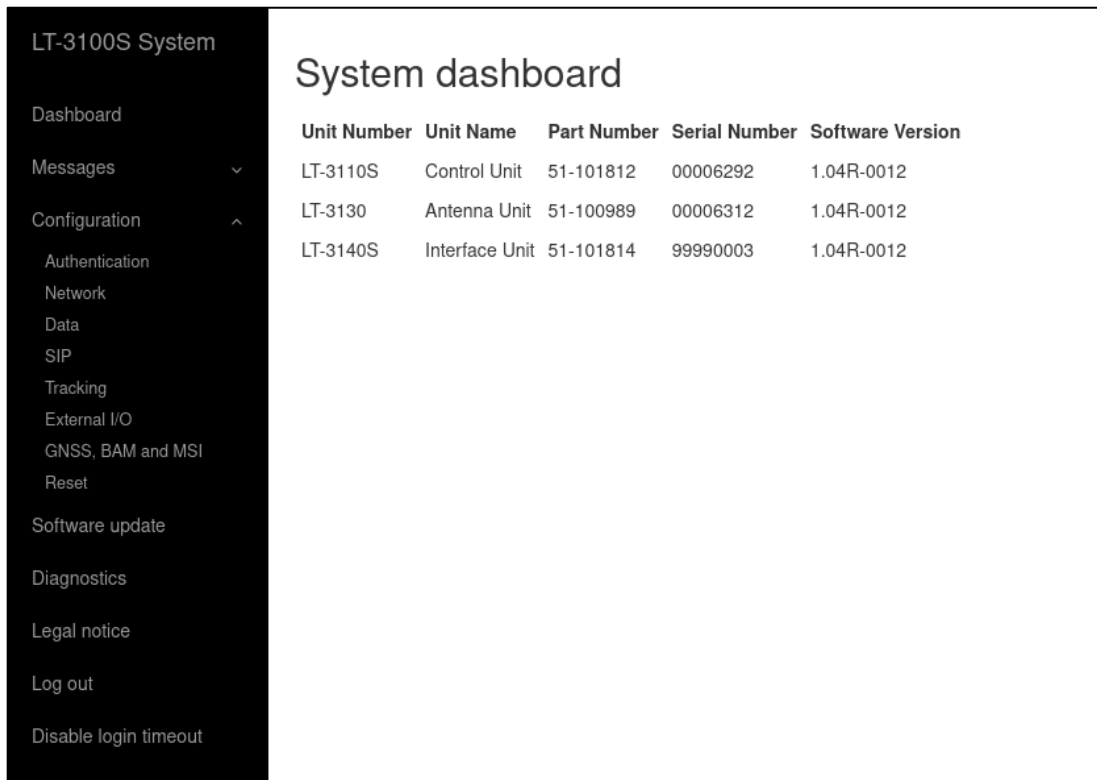

The screenshot shows the 'System dashboard' of the LT-3100S system. On the left is a dark sidebar menu with the following items: Dashboard, Messages (with a dropdown arrow), Configuration (with an expand arrow), Authentication, Network, Data, SIP, Tracking, External I/O, GNSS, BAM and MSI, Reset, Software update, Diagnostics, Legal notice, Log out, and Disable login timeout. The main content area displays a table with the following data:

Unit Number	Unit Name	Part Number	Serial Number	Software Version
LT-3110S	Control Unit	51-101812	00006292	1.04R-0012
LT-3130	Antenna Unit	51-100989	00006312	1.04R-0012
LT-3140S	Interface Unit	51-101814	99990003	1.04R-0012

Figure 301: Web server (Configuration)

Under Configuration, the following webpages are available:

- Authentication
- Network
- Data
- SIP
- Tracking
- External I/O
- GNSS, BAM and MSI
- Reset

Authentication

The LT-3100S GMDSS system support configuration of authentication on the web server.

The default password for the User = admin and Password = admin. The LT-3100S GMDSS system will always be delivered from Lars Thrane A/S with the default password configured.

NOTE: It is highly recommended that the installer of the LT-3100S GMDSS system changes the default password during the installation of the system, so that a random user on the network does not have access to the web server.

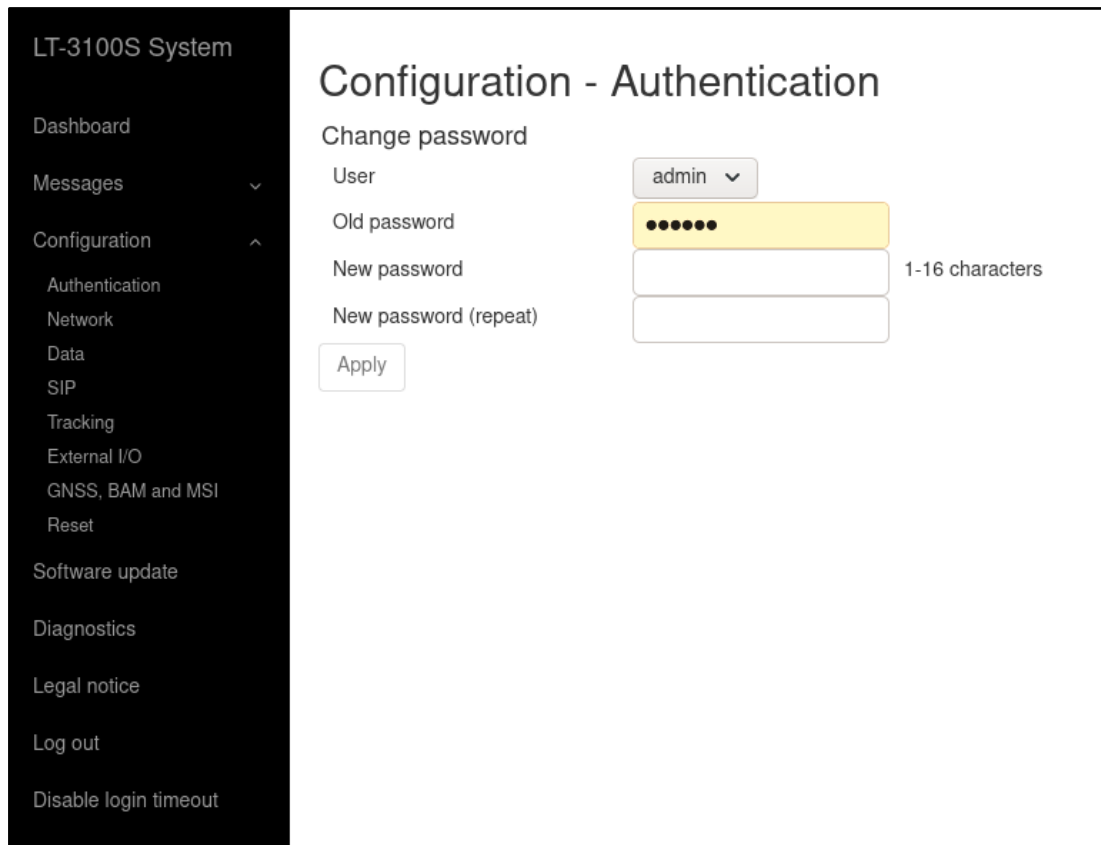

Figure 302: Web server (Authentication)

If the authentication password is changed from default and forgotten, then the authentication password can be reset from the display (MENU -> Settings -> Reset Options: Reset Web Authentication). Remember to change the authentication password away from the default password, as soon as it has been possible to re-enter the web server. The Reset Web Authentication is further described and illustrated in *Settings* on page 157.

MSI login

The LT-3100S GMDSS system supports configuration of a separate web server login for the purpose of reading MSI. Upon selecting the MSI profile, the operator is prompted to create a new password for logging in as the MSI user, this is displayed on Figure 303.

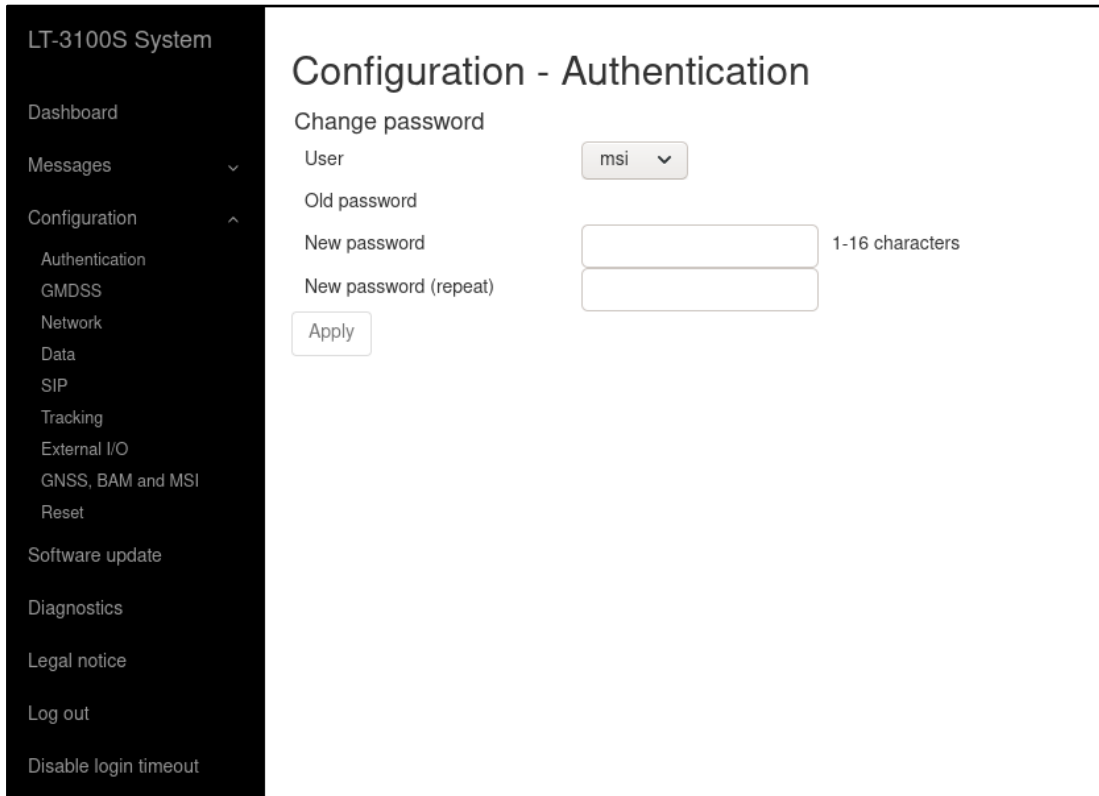

Figure 303: Web server (MSI login)

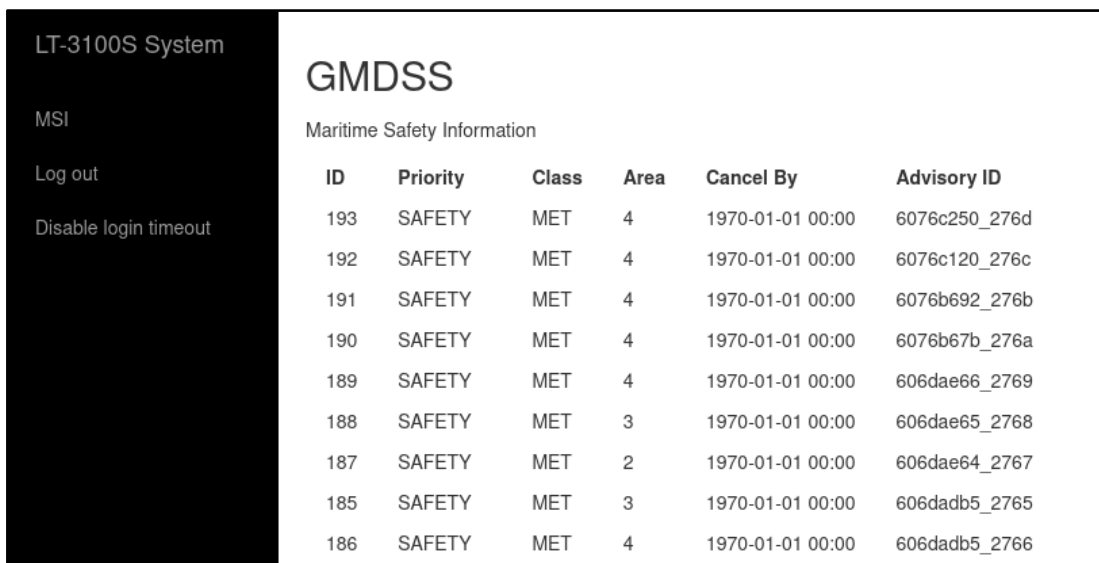

Figure 304: Web server (MSI login)

When logging in using the MSI profile, only the MSI tab will be available. From here MSI can be read, this is displayed in Figure 304.

NOTE: It is recommended that the installer of the LT-3100S GMDSS system sets the MSI profile password during the installation of the system. It is highly recommended to keep the MSI profile password different from the admin profile password.

Network

The LT-3100S GMDSS system is supporting the most common network configurations for Local Area Network (LAN). The LT-3100S GMDSS system has one Ethernet (RJ45) interface, which is described in *Ethernet RJ45 (LAN)* on page 35.

The following network configuration modes will be described in this section:

- DHCP client
- DHCP server
- Static

The default network configuration mode for the Ethernet interface is DHCP client.

The screenshot shows the web interface for the LT-3100S System. On the left is a dark sidebar menu with options: Dashboard, Messages, Configuration (expanded), Authentication, Network, Data, SIP, Tracking, External I/O, GNSS, BAM and MSI, Reset, Software update, Diagnostics, Legal notice, Log out, and Disable login timeout. The main content area is titled 'Configuration - Network'. Under the 'DNS' section, there are two input fields: 'Hostname' containing 'lt-3100s' and 'Domain' containing 'thrane.io'. Under the 'Ethernet interface' section, there is a 'Mode' dropdown menu currently set to 'DHCP client' and an 'Apply' button below it.

Figure 305: Web server (Network - DHCP client)

NOTE: In DHCP client mode, Link-local is supported, in order to connect another 'passive' IP-device (e.g. a PC) directly to the LT-3110S Control Unit. Expect the LT-3110S Control Unit to get the IP-address: 169.254.1.1.

NOTE: The IP-address of the LT-3110S Control Unit is always available from the display (MENU -> System -> Network), see details in *System* on page 161. If the LT-3110S Control Unit is starting up showing the Installation Wizard, then make a short press on the MENU button and details will be available (incl. the IP Address of the control unit).

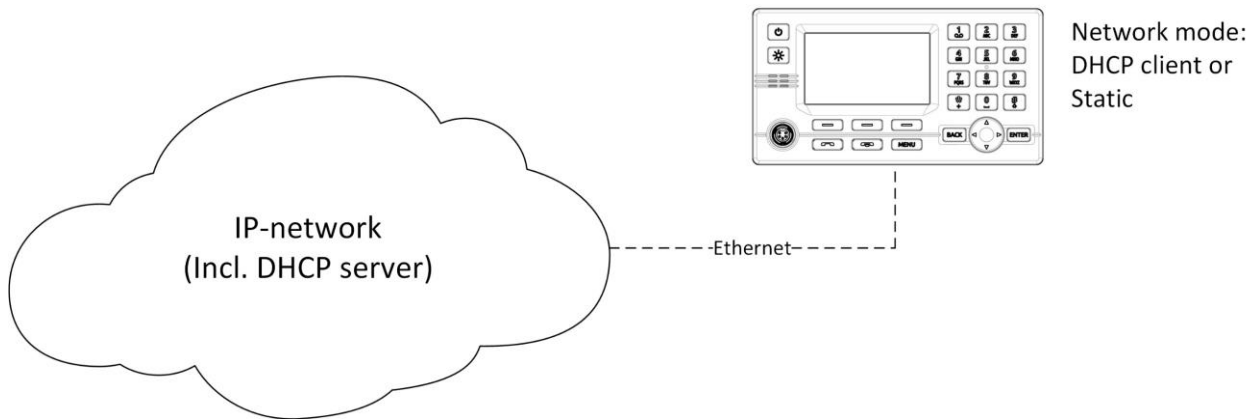

Figure 306: LT-3100S GMDSS System and IP Network

If the LT-3100S GMDSS system is connected to a local network as illustrated in Figure 306, where a DHCP server is already available, then the LT-3100S GMDSS system must be configured to either DHCP client or Static mode. The Static mode can be used, if it is required that the IP-address of the LT-3110S Control Unit must never change.

The LT-3100S GMDSS system has two reserved network ranges, which are documented in Table 47.

Reserved Network Ranges	
Reserved	Sub-nets
Reserved External	192.168.255.0/24 - i.e. 192.168.255.0 netmask 255.255.255.0
Reserved Internal	172.27.0.0/16 - i.e. 172.27.0.0 netmask 255.255.0.0

Table 47 Reserved Network Ranges

NOTE: The LT-3140S Interface Unit contains a 4-port Layer 2 Ethernet (network) Switch. When an LT-3140S Interface Unit is connected to the LT-3110S Control Unit, then it is possible to use one of the three remaining Ethernet (RJ45) ports to connect to an external IP network. The LT-3140S Interface Unit will behave as a passive network switch between the LT-3110S Control Unit and the external IP network.

IMPORTANT: Do not connect the LT-3100S GMDSS System to any external IP networks, which are not trusted. The LT-3110S Control Unit and LT-3140S Interface Unit both have Firewall rules configured on all Ethernet ports to avoid unwanted IP traffic.

DHCP client

The DHCP client mode is the configuration of the LT-3110S Control Unit from the factory. The DHCP client mode must be used, if the IP network already has a DHCP server available.

DHCP Server

The DHCP server mode must be used when connecting the LT-3110S Control Unit directly to another IP-device or local network, where no DHCP server is offered, and where it is required that a DHCP server is offered for assigning IP addresses to network clients. The web server DHCP server mode setting is illustrated in Figure 307.

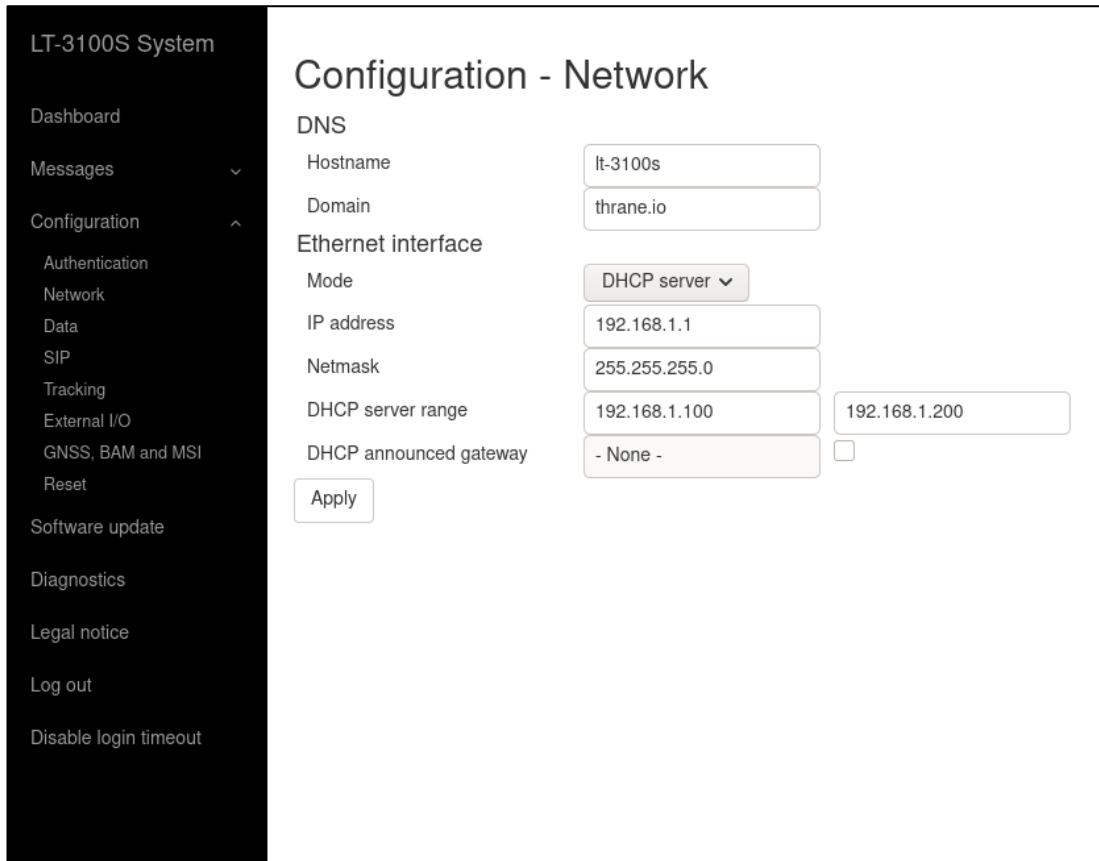

Figure 307: Web server (Network - DHCP server)

NOTE: A user scenario for configuration the DHCP server mode is when e.g. connecting IP-based communication devices: Analogue Phone Adapter or SIP Phones directly to the LT-3110 Control Unit via the Ethernet interface. Connecting an Analogue Phone Adapter is further described in *Analogue Phone Adapter* on page 146.

Static

The Static mode must be used when the IP address of the LT-3110 Control Unit must never change. Typically used, if connecting the LT-3110 Control Unit to an IP network, where a DHCP server is already available, and where it is important that the IP address assigned for the LT-3110 Control Unit is never changed.

Data

The LT-3100S GMDSS system is supporting Modem Data (Direct Internet and RUDICS) services via Serial over Ethernet on the Ethernet (RJ45) interface, which is described in *Ethernet RJ45 (LAN)* on page 35. The Modem Data services are described in *Data* on page 147.

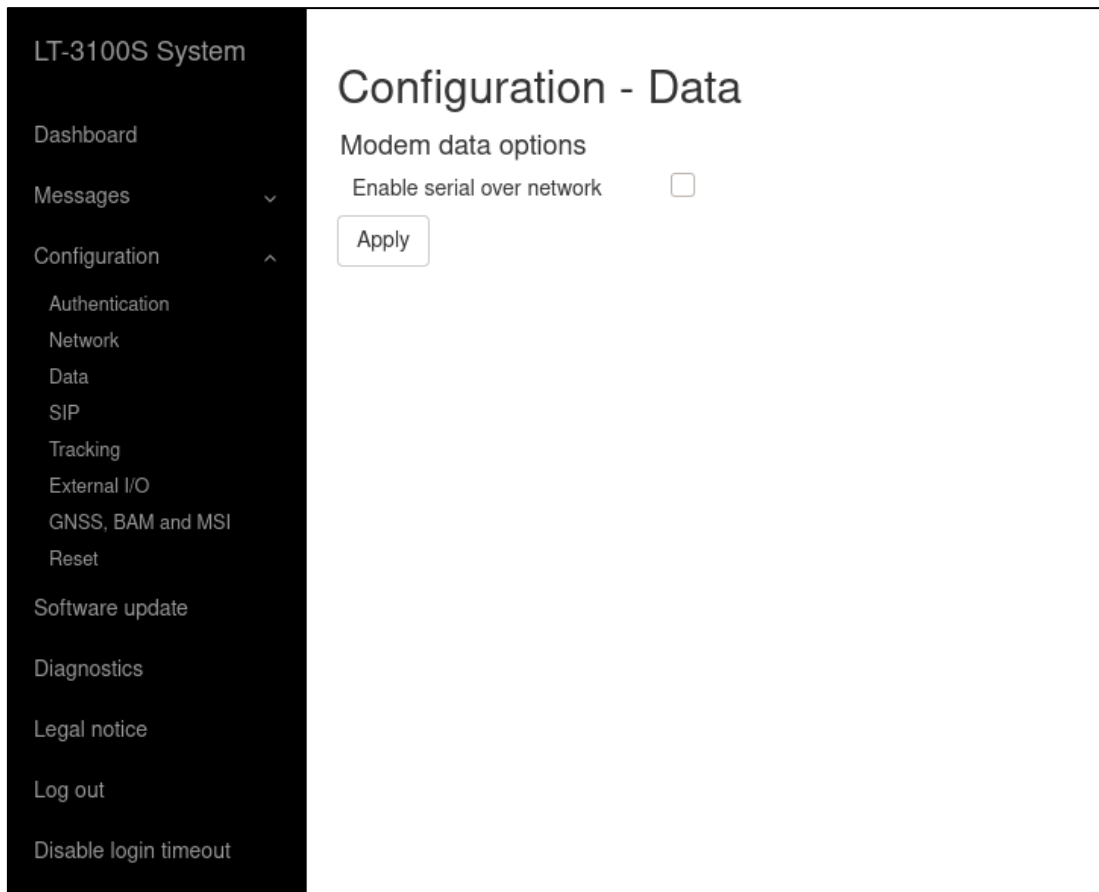

Figure 308: Web server (Data)

By activating ‘Enable serial over network’ the LT-3110S Control Unit will give access to the AT-command interface (port 5020) on the IP-address. The LT-3100S GMDSS System is supporting Serial over Ethernet (RFC 2217), incl. all the hardware control signals, emulated over the Ethernet interface. It may be required to install a Virtual COM port (e.g., the Serial Port Redirector license) to have an external application work properly utilizing the Modem Data services.

SIP

The LT-3100 System has a built-in PBX trunk (SIP), which support internal and external satellite calling. The LT-3100 system only supports 1 x Iridium satellite voice channel. The PBX trunk (SIP) can be accessed via Ethernet, RJ45. Up to 8 external SIP devices can be registered in the PBX trunk. The web server, Configuration - SIP is illustrated in Figure 309.

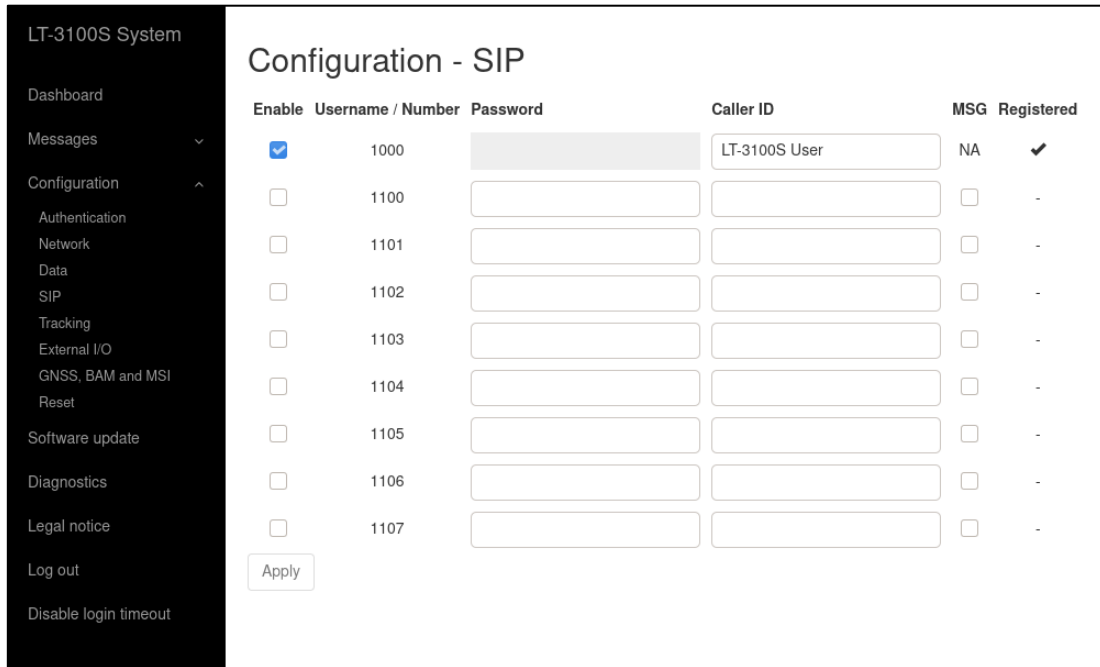

Figure 309: Web server (SIP)

In the LT-3110S Control Unit display (MENU -> System -> SIP) it is possible to get an actual status of the number of SIP devices and their registration status. This is further illustrated and described in *System on page 161*.

The following external applications requires a SIP configuration:

- Connection of ships PBX
- External SIP Phones
- External Analogue Phone Adapter
- SIP Softphones via external Wi-Fi Access Point (WAP)

NOTE: External SIP phones and registered SIP devices can only initiate and receive voice calls (priority = routine). If an external SIP phone is in an active voice call, then a dedicated symbol will be shown in the status bar (see Table 19 on page 53). A Safety Call will always preempt the voice call (priority = routine).

An incoming voice call (priority = routine) to the LT-3100S GMDSS system, will be signaled to all external SIP devices. The first SIP devices or LT-3120 Handset answering the incoming voice call will be connected. The LT-3100S GMDSS system is currently not supporting call forwarding.

Tracking

The LT-3100S GMDSS system is supporting tracking (position reporting) using different transport types and report formats. This section will briefly describe the different Tracking configurations options. For more details on Lars Thrane A/S tracking protocol supported in the LT-3100S GMDSS system, please get in contact with Lars Thrane A/S. Figure 310 is illustrating the web server, configuration - tracking.

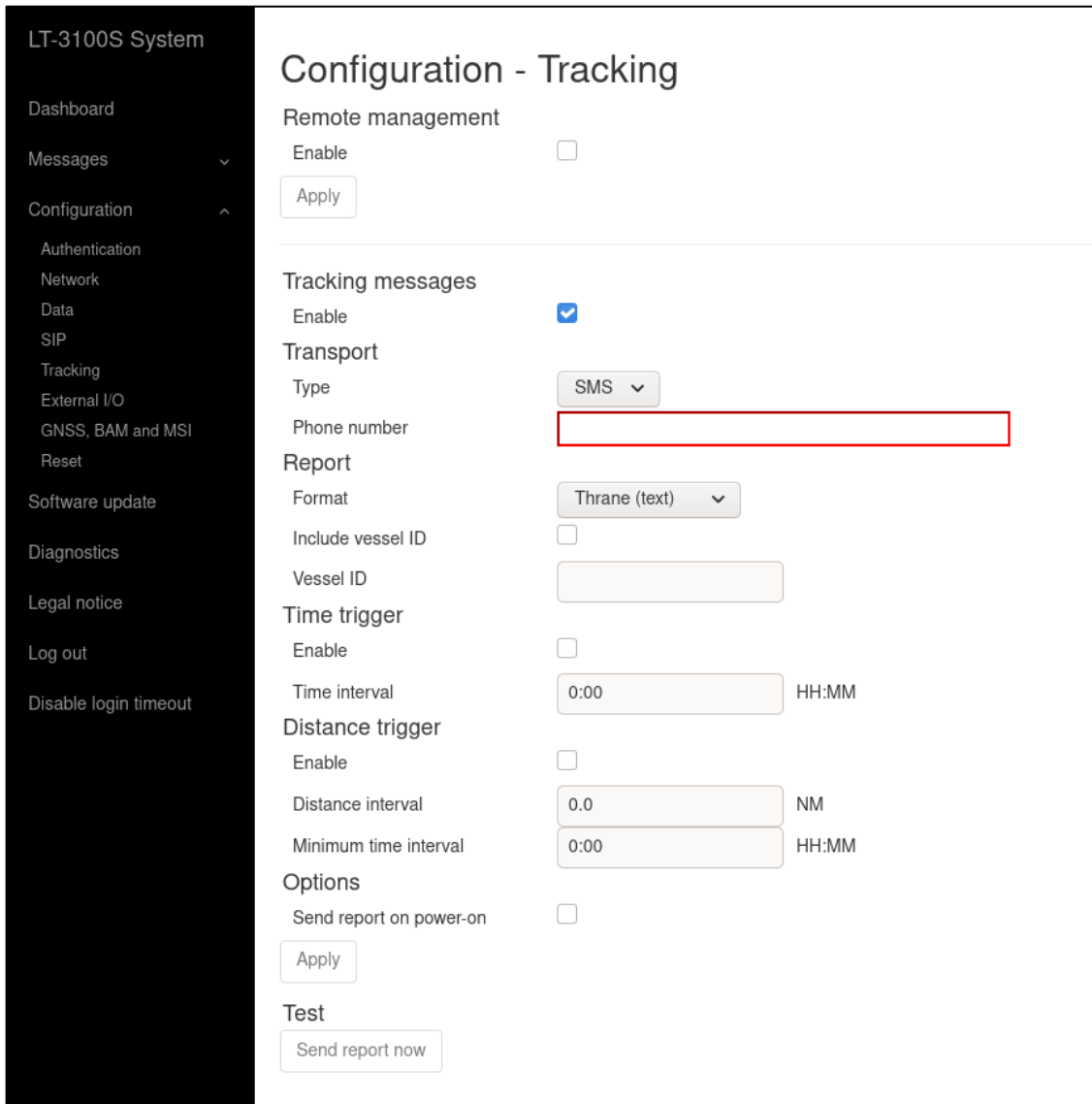

Figure 310: Web server (Tracking)

The tracking transport types, and report formats currently supported in the LT-3100S GMDSS system are summarized in Table 48.

Transport Types & Report Formats		
Transport Type	Report Format	Comments
SMS	Thrane (text)	Text format to be used for machine reading and decoding
	Human readable	Text format to be used for human reading
E-mail	Thrane (text)	Text format to be used for machine reading and decoding
	Human readable	Text format to be used for human reading

Table 48: Web server - Tracking (transport types and report formats)

NOTE: Lars Thrane A/S has an Interface Control Document (ICD) with details describing the following content: binary and text formats, remote management (configuration, requesting position report, and trigger position report). In order to support the Thrane (binary) format it is a requirement to get access to this ICD. The SBD binary format is not supported in the LT-3100S GMDSS system.

The trigger configuration options and intervals are summarized in Table 49.

Trigger Configurations			
Trigger	Format	Interval	Comments
Time			
Time interval	HH:MM	0:01 to 168:00	Time can be configured from 0.01 (1 minute) to 168:00 (up to 7 days)
Distance			
Distance interval	NM	0.1 to 999	Distance can be configured from 0.1 to 999 NM
Minimum time interval	HH:MM	0:01 to 168:00	Minimum time can be configured from 0.01 (1 minute) to 168:00 (up to 7 days)

Table 49: Web server (Tracking - trigger configurations)

The time and distance trigger conditions can be configured individually. A tracking report will be sent, when a trigger condition has been met - time and/or distance. The trigger algorithm will 'reset' every time a tracking report has been sent.

The time trigger condition can be configured from 1 minute (0:01) and up to 7 days (168:00). The distance trigger condition can be configured from 0.1 NM and up to 999.0 NM. For the distance trigger condition, it is possible to configure a Minimum time interval, which has the purpose to make sure that not too many tracking reports are sent.

Example: If the distance interval is configured to 5.0 NM and Minimum time interval is configured to 01:00 hour, then position reports will be sent, when both requirements have been met (maximum every 1 hour). If the speed over ground is < than 5 knots, then a tracking report will be sent every 5.0 NM. If the speed over ground is > 5 knots, then a tracking report will be sent every 1 hour.

Under Options - Send report on power-on it is possible to configure the LT-3100S GMDSS system to send a tracking report every time the terminal is powered on.

Use the button 'Send report now', illustrated in Figure 310 on page 191, to overwrite the tracking algorithm and send a tracking report instantly. Also, use the button to test the format of the tracking reports after tracking configurations have been applied.

NOTE: The LT-3110S Control Unit display has a tracking window (MENU -> System -> Tracking), providing tracking status overview. From this tracking window, it is possible to initiate a periodic tracking report (if configured) or initiate a tracking message, which will be sent to either an SMS or E-mail destination. For further details see *Tracking* on page 150.

SMS

The LT-3100S GMDSS system supports SMS as transport type for tracking reports, see configuration options in Figure 311. The SMS tracking is supporting two formats: ‘Thrane (text)’ and ‘Human readable’.

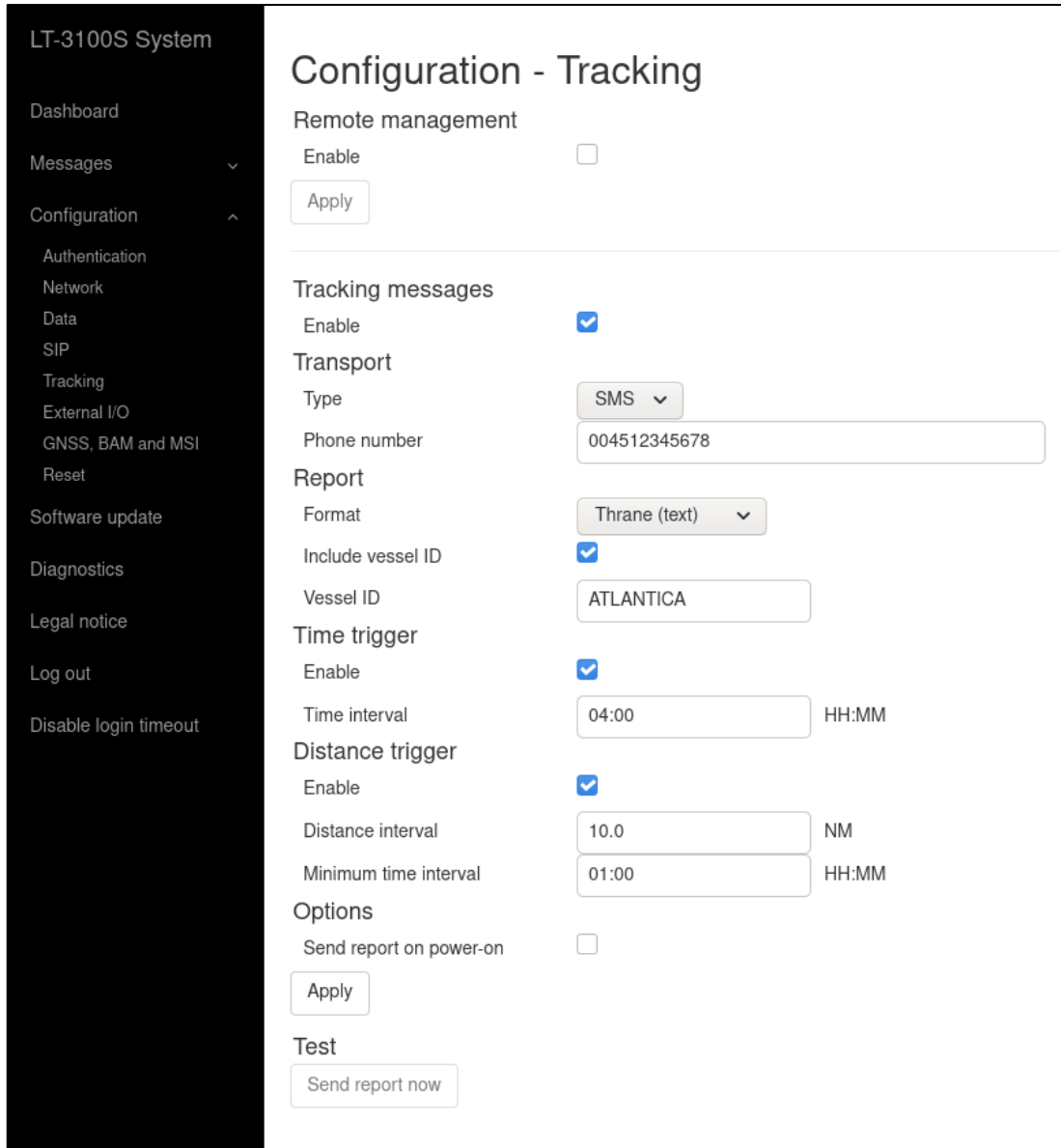

Figure 311: Web server (Tracking - SMS)

The format of a tracking report ‘Human readable’ sent to e.g. a smartphone is illustrated in Figure 312.

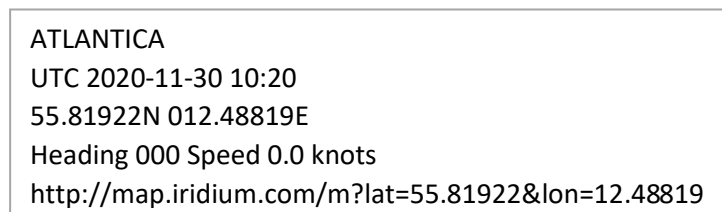

Figure 312: Tracking Report (SMS - Human Readable)

E-mail

The LT-3100S GMDSS system supports E-mail as transport type for tracking reports, see configuration options in Figure 313. The E-mail tracking is supporting two formats: ‘Thrane (text)’ and ‘Human readable’.

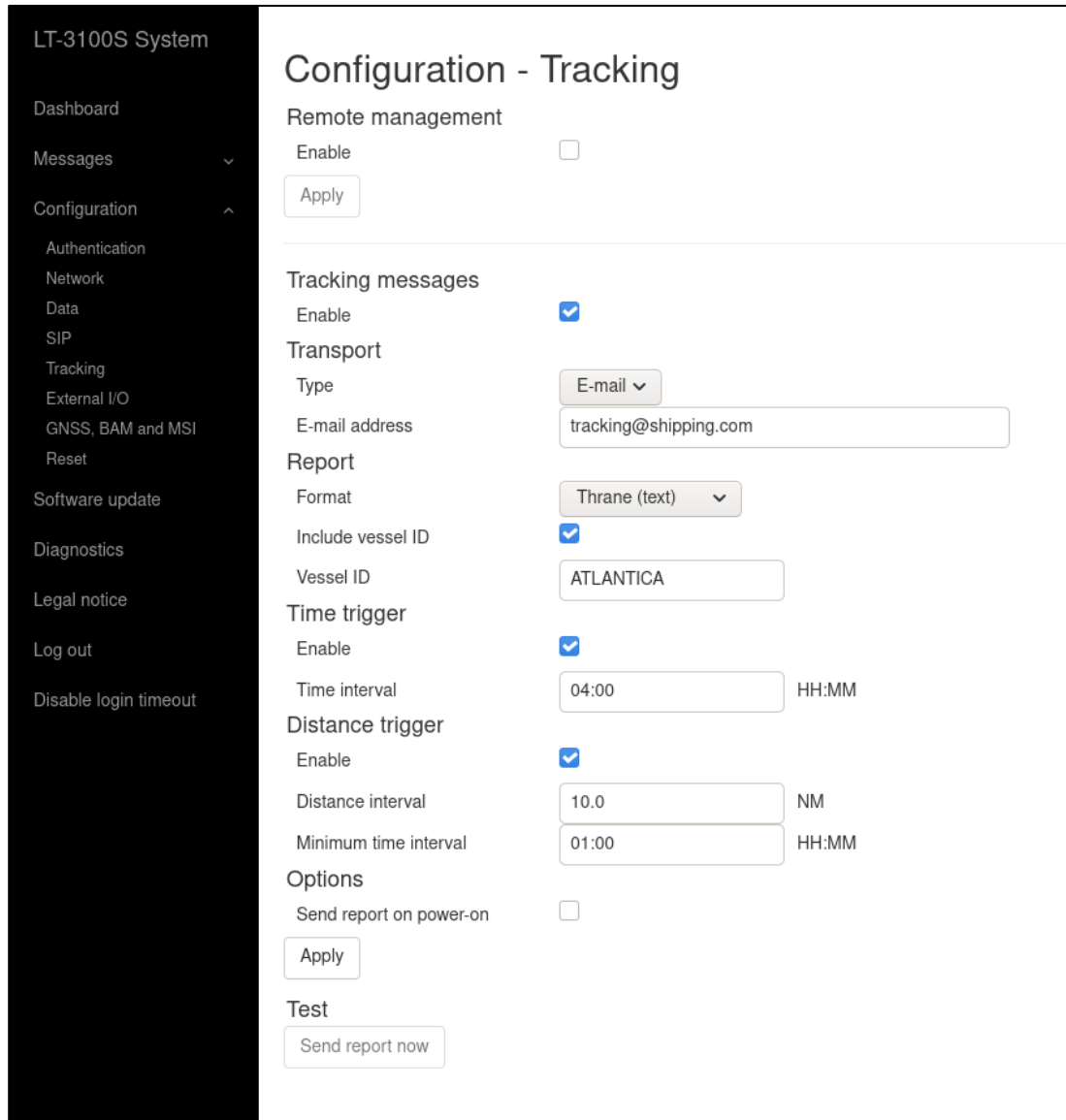

Figure 313: Web server (Tracking - E-mail)

The format of a tracking report ‘Thrane (text)’ sent to an E-mail address is illustrated in Figure 314.

```
SMS from 88XXXXXXXXXX@msg.iridium.com
88XXXXXXXXXXXX@iridium.com
To: tracking@shipping.com
LT=T;M=P;D=1603985517,0,55.81921,12.48818,39.6,0.0;VI=ATLANTICA
```

Figure 314: Tracking Report (E-mail - Thrane (text))

Remote management

The LT-3100S GMDSS system supports Remote Management for the tracking application. In order for Remote Management to work, the Remote Management must be enabled by the user and a password must be chosen as illustrated on Figure 315. The Remote Management is using the General Messaging (~SMS) service as communication layer.

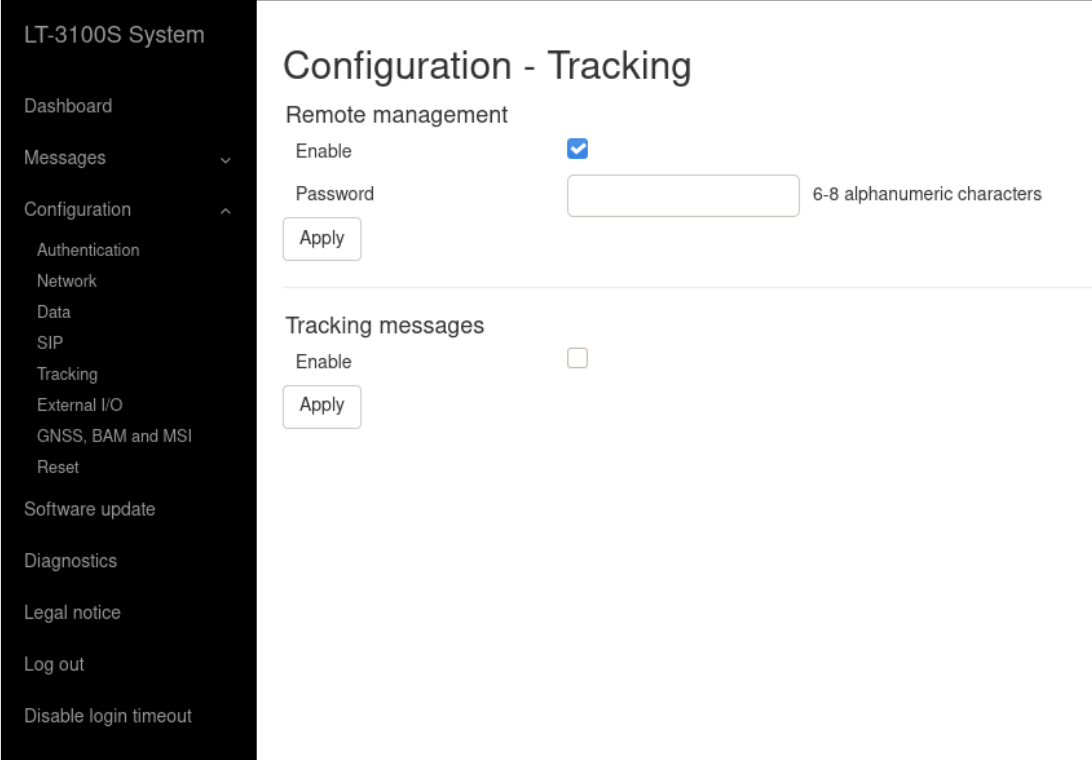

The screenshot shows the 'Configuration - Tracking' page of the LT-3100S System web server. The left sidebar contains a navigation menu with the following items: Dashboard, Messages, Configuration, Authentication, Network, Data, SIP, Tracking, External I/O, GNSS, BAM and MSI, Reset, Software update, Diagnostics, Legal notice, Log out, and Disable login timeout. The main content area is titled 'Configuration - Tracking' and is divided into two sections. The first section, 'Remote management', has an 'Enable' checkbox checked and a 'Password' input field with a placeholder '6-8 alphanumeric characters'. Below this is an 'Apply' button. The second section, 'Tracking messages', has an 'Enable' checkbox unchecked and an 'Apply' button below it.

Figure 315: Web server (Tracking - Remote Management)

The Tracking Remote Management functionality is supporting:

- Request Position Report
- Trigger Position Report
- Change Tracking Configuration

NOTE: For further details about the Remote Management functionality, please contact Lars Thrane A/S.

External I/O

The LT-3100S GMDSS system supports configuration of External I/O. The LT-3100S GMDSS system has one input and one output supported in the AUX connector. The AUX connector is described in *Auxiliary (AUX)* on page 36. Figure 316 is illustrating the configuration of the External I/O.

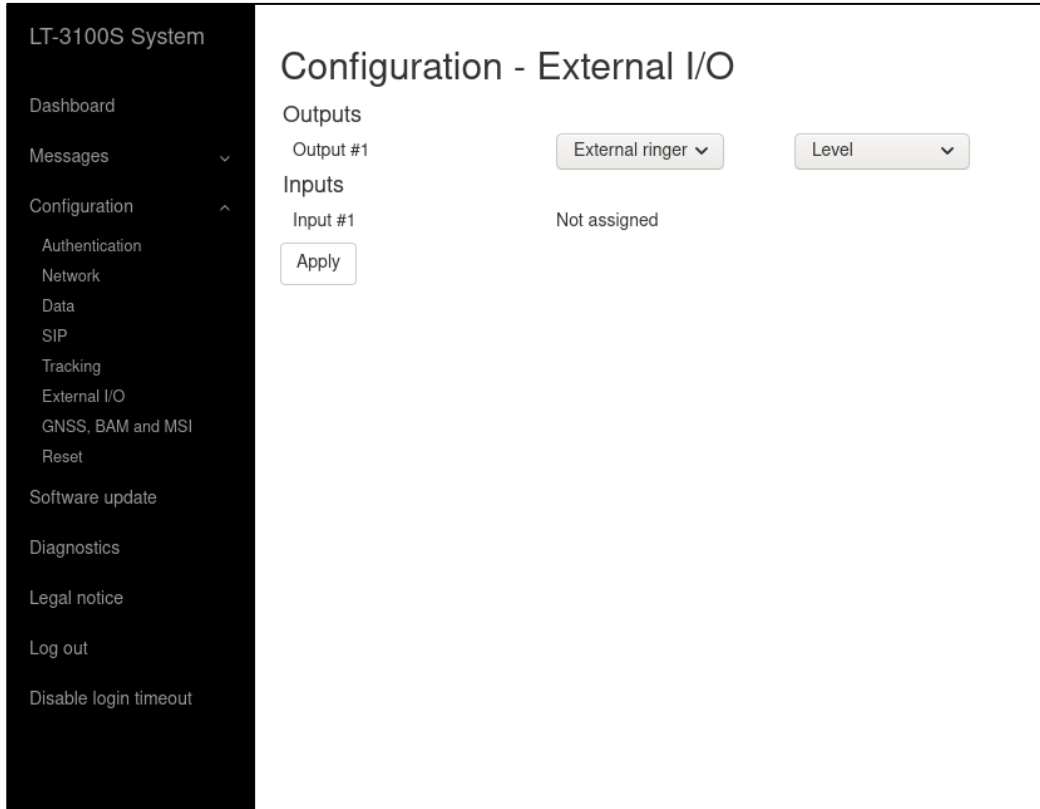

Figure 316: Web server (External I/O)

Output

The External I/O output configuration options are listed in Table 50.

External I/O - Output Configuration	
Not assigned	default
External ringer	Level
	Pulse @ 0.5 Hz
	Pulse @ 1 Hz
	Pulse @ 2 Hz

Table 50: External I/O (Output)

Input

The LT-3100S GMDSS system is currently not supporting any functionality for the External I/O input.

GNSS, BAM and MSI

The LT-3100S GMDSS system has a built-in GNSS receiver located in the LT-3130 Antenna Unit. The GNSS receiver is used for time, date, and position of the LT-3100S GMDSS system, for example used for position reporting in connection with sending a Distress Alert message or used by the tracking application. The GNSS receiver can be configured to operate on different satellite systems (e.g., GPS only) - this can be managed under the GNSS module, as illustrated in Figure 317.

It is possible to configure the following functionality: GNSS, BAM and MSI on the LT-3110S Control Unit (CU - AUX) and LT-3140S Interface Unit (IU - Port 1 and IU - Port 2) interfaces, respectively.

This section describes the following configuration options:

- GNSS module
- GNSS (output of NMEA 0183 sentences)
- Bridge Alert Management (BAM)
- Maritime Safety Information (MSI)

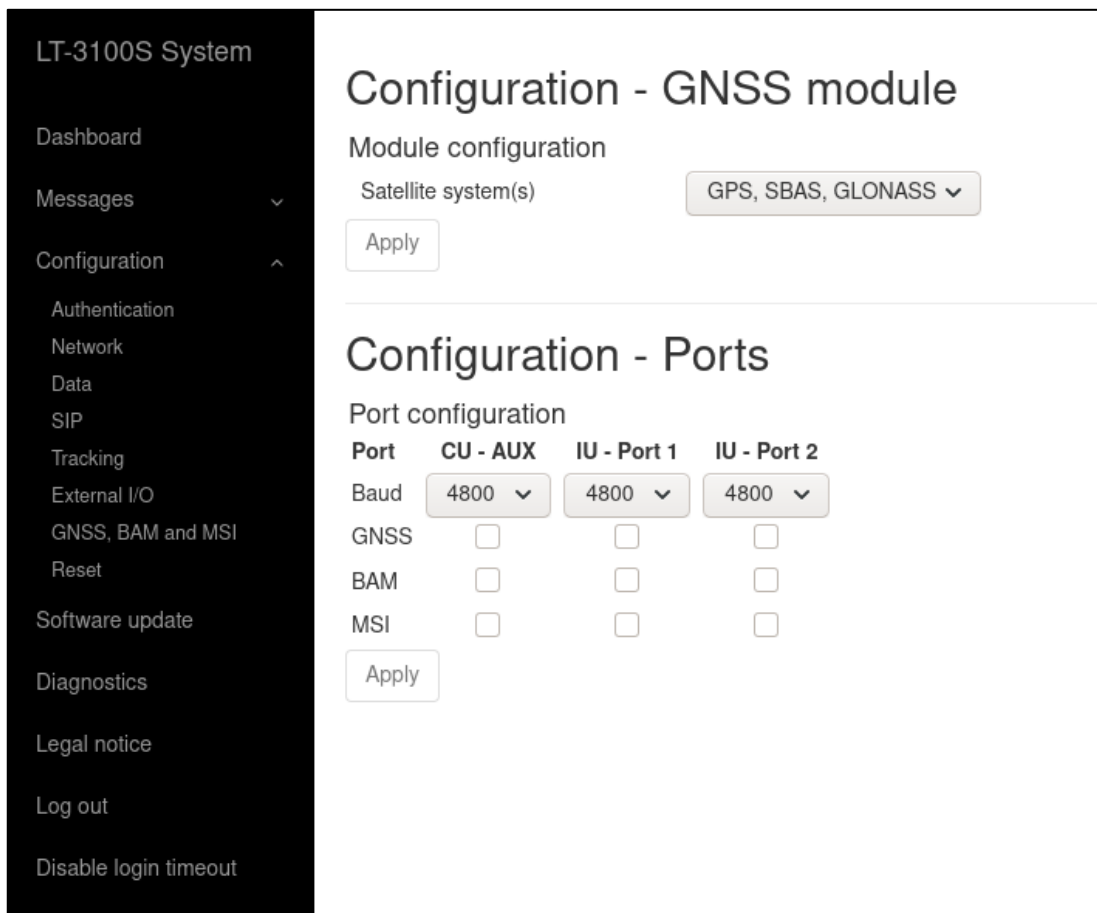

Figure 317: Web server (GNSS, BAM and MSI)

NOTE: The Port configuration illustrated above in Figure 317 for GNSS, BAM and MSI supports the following baud rates: 4800, 9600, and 38400. The baud rate can be configured individually per port. The ports are all bi-directional RS-422. Only BAM can receive data.

GNSS module

The GNSS receiver used in the LT-3130 Antenna Unit is a 72 ch. receiver with SBAS reception. The GNSS receiver performance is listed in Table 51.

GNSS receiver performance			
Data	Accuracy	Resolution	Comments
Position	GNSS: < 2.5 m SBAS: < 2 m	0.1 m	CEP, 50%, 24 hours static, -130 dBm, > 6 SVs By default, the GNSS receiver is configured for GPS, SBAS, GLONASS reception Time-To-First-Fix (cold acquisition): 26 s.
SOG	0.1 knot	0.1 knot	0 to 195 knots

Table 51: GNSS receiver performance

The GNSS receiver can be configured to the options listed in Table 52. The GPS, SBAS, GLONASS configuration is the recommended configuration.

GNSS Receiver configuration	
GNSS Receiver	Talker ID
GPS, SBAS, GLONASS	GN
GPS, SBAS, BeiDou	GN
GPS, SBAS	GP
GPS	GP
GLONASS	GL
BeiDou	GB

Table 52: GNSS receiver configuration

The horizontal position accuracy (static) has been measured for different configurations of the GNSS receiver, see Figure 318.

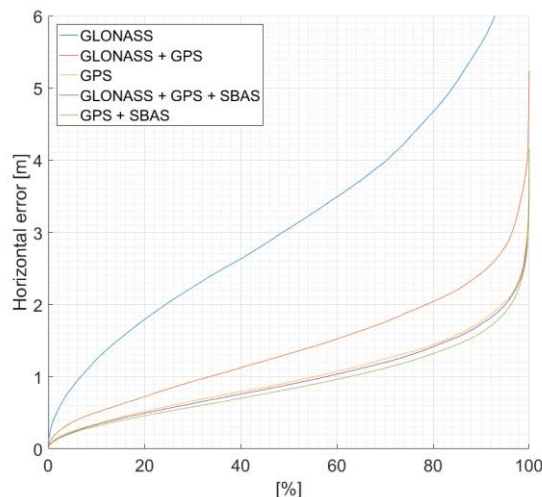

Figure 318: GNSS receiver horizontal position error

IMPORTANT: The installation of the LT-3130 Antenna Unit will affect the performance of the GNSS receiver. If line-of-sight to the GNSS satellites are disturbing the quality of the signal received by the GNSS receiver, then degraded performance must be accepted.

GNSS

The LT-3100S GMDSS system supports outputting of GNSS NMEA 0183 sentences via the LT-3110S Control Unit AUX (RS-422) or via the LT-3140S Interface Unit RS-422 (Port 1 or Port 2) interface. The AUX connector is described in detail in *Auxiliary (AUX)* on page 36. The GNSS output must be enabled via the web server, under Configuration - GNSS, BAM and MSI. The baud rate can be configured to 4.800, 9.600, or 38.400 baud. The output rate of the NMEA 0183 sentences is 1 Hz. Figure 319 below shows the NMEA 0183 sentences supported by the LT-3100S GMDSS system.

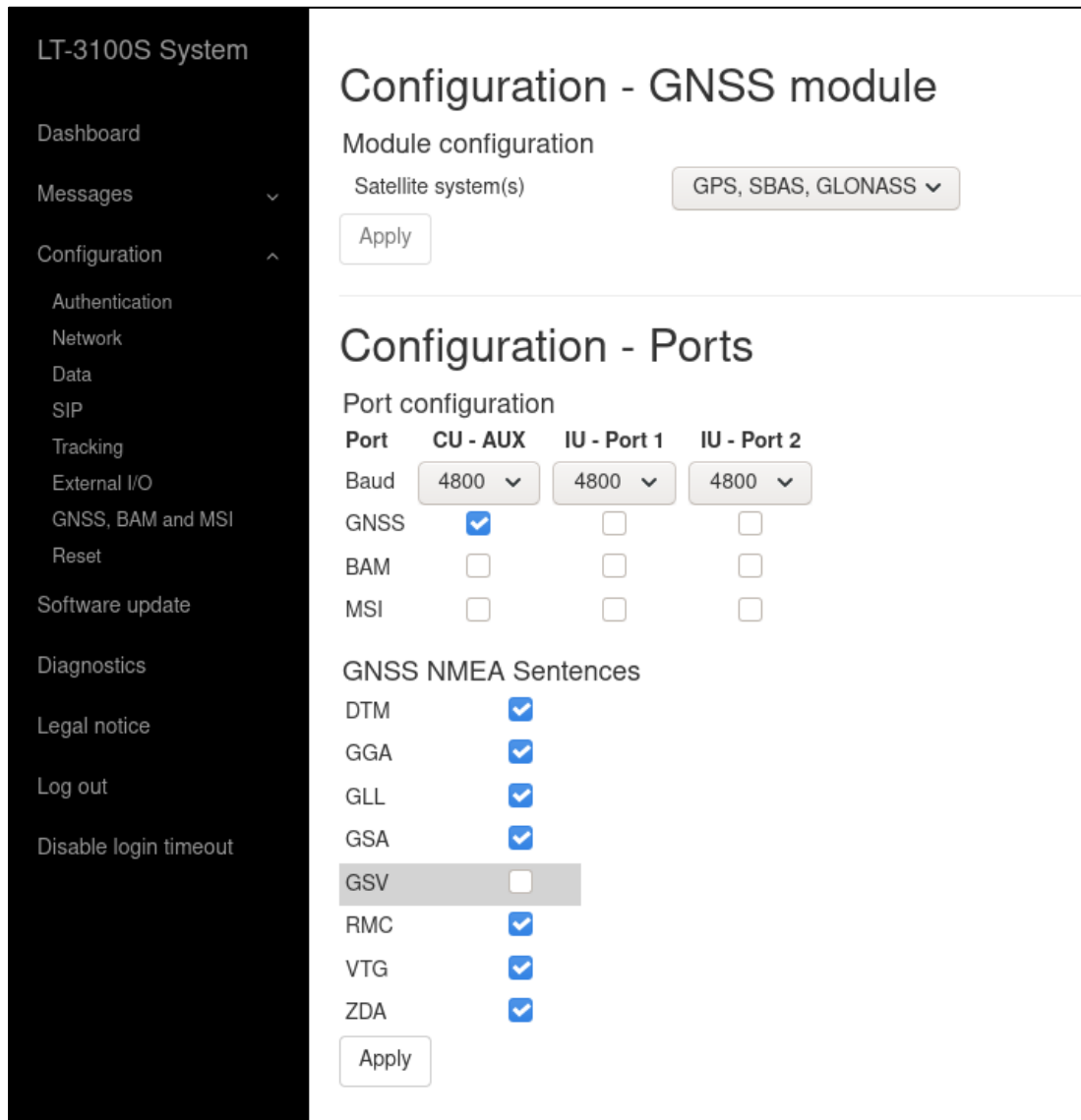

Figure 319: Web server (GNSS - NMEA 0183 sentences)

The GSV sentence is not supported for the 4.800 and 9.600 baud configuration.

NOTE: Changing the GNSS receiver configuration (default: GPS, SBAS, GLONASS) might affect the NMEA 0183 Talker ID. The Talker ID for the different configurations of the GNSS receiver is listed in Table 52 on page 198.

BAM and MSI

The LT-3100S GMDSS system supports BAM and MSI via the LT-3110S Control Unit AUX (RS-422) or via the LT-3140S Interface Unit RS-422 (Port 1 or Port 2) interface. The AUX connector is described in detail in *Auxiliary (AUX)* on page 36. BAM and MSI must be enabled via the web server, under Configuration - GNSS, BAM and MSI. The baud rate can be configured to 4.800, 9.600, or 38.400 baud. The BAM and MSI functions must be enabled individually on separate interfaces, see Figure 320 below.

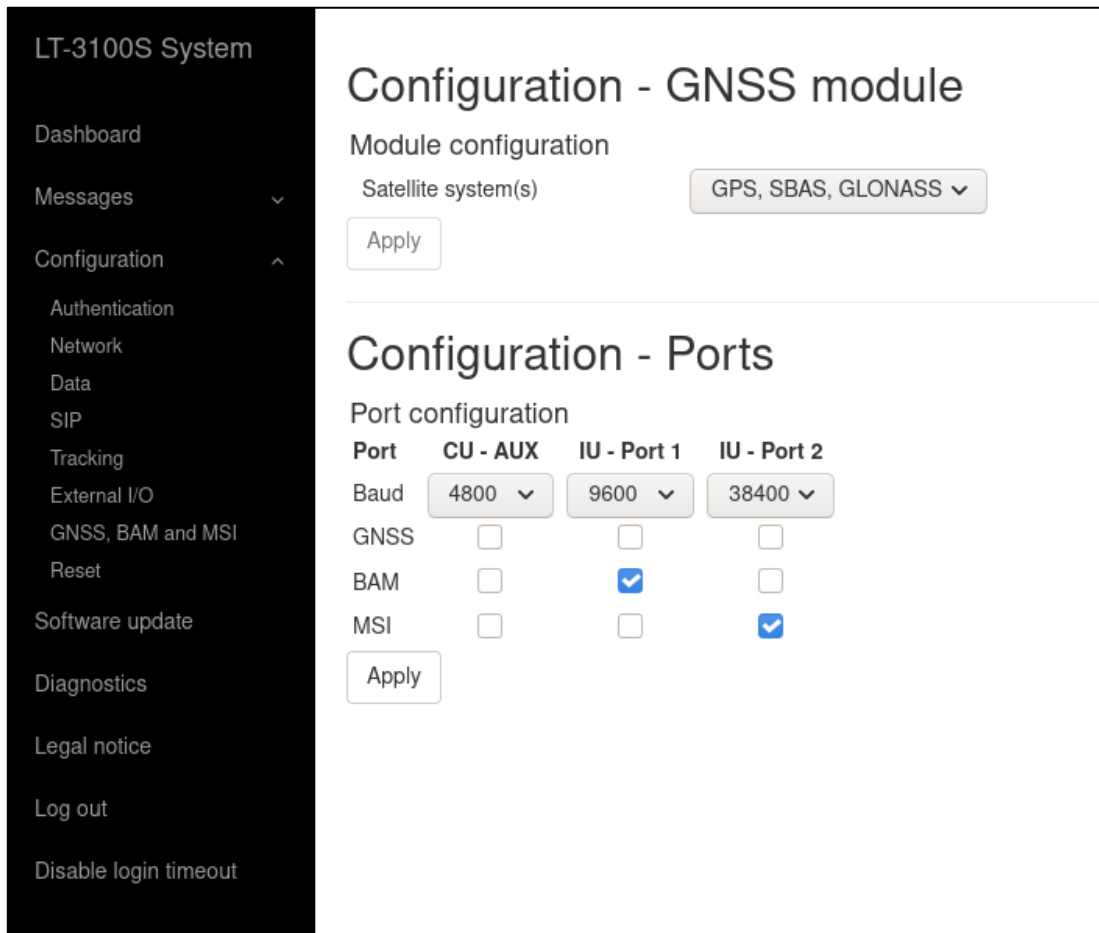

Figure 320: Web server (BAM and MSI)

NOTE: The LT-3110S Control Unit AUX connector is providing one bi-directional RS-422 interface. The LT-3140S Interface Unit RS-422 (Port 1 and 2) is providing two bi-directional RS-422 interfaces.

The Supported BAM sentences are described in *BAM sentences* on page 174. The Supported MSI sentences are described in *MSI sentences* on page 175.

Reset to factory default

The LT-3100S GMDSS system support a reset to factory default. This reset functionality is only available via the web server, see Figure 321. By pressing 'Reset to factory default' and acknowledging this reset, the LT-3100S GMDSS system will configure all settings to default and remove all user data (e.g., Contact List, Call History, SMS, Safety Messages, Safety Calls, MSI, etc.). The LT-3100S GMDSS system will reboot once the factory reset has been affected and start up again showing the Installation Wizard in the display. The Installation Wizard must be completed again before the system is operational. The Installation Wizard is described and illustrated in *Installation Wizard* on page 61.

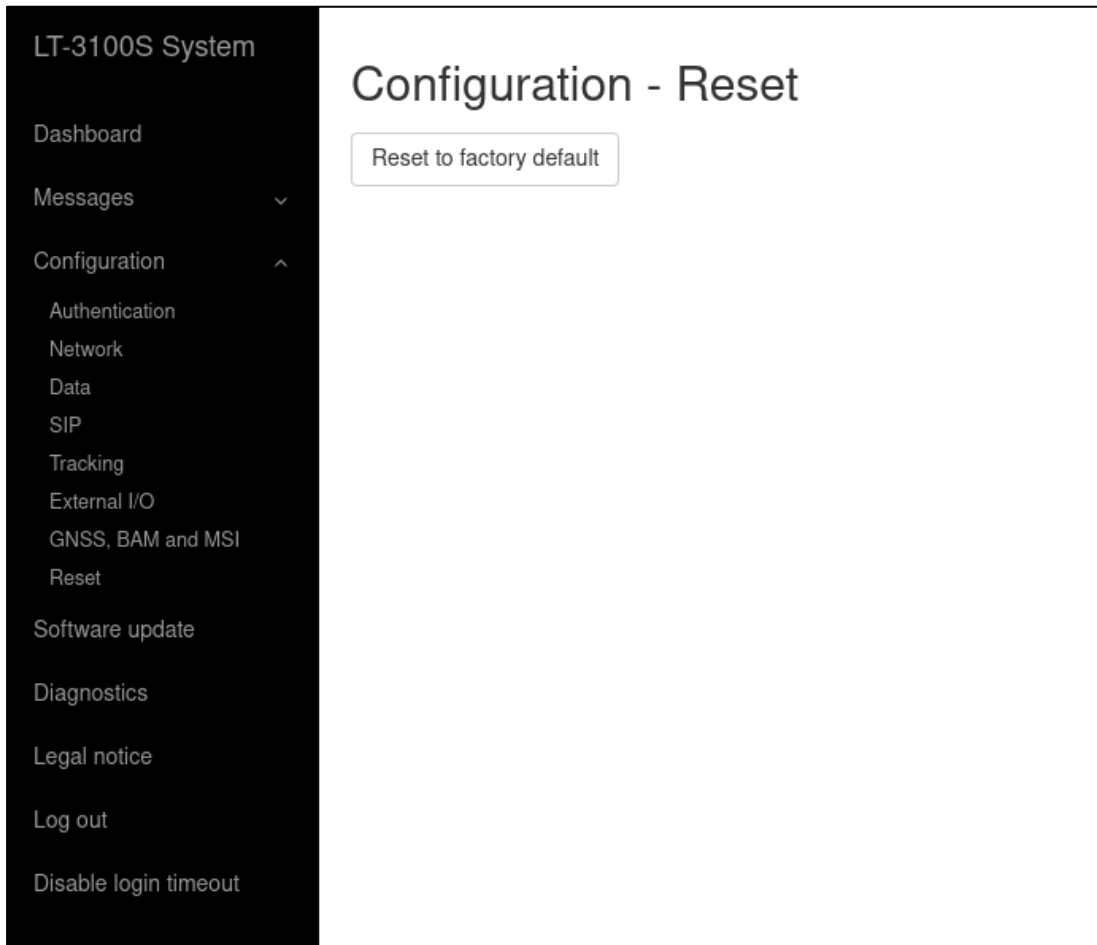

Figure 321: Web server (Reset to Factory Default)

NOTE: By 'Reset to factory default' the LT-3100S GMDSS system will lose all settings configured and user data will be lost. The system will be operational again once the Installation Wizard has been completed.

NOTE: A factory default reset will configure the following display and audio settings:
Display: Mode = Day time and Brightness = 70%.
Audio: Speaker Volume = 80%, handset Volume = 60%, Ringer Volume = 80%, and Key Beep = 40%.

Software update

Carefully read the software release note, provided by Lars Thrane A/S, before software updating the LT-3100S GMDSS system.

Access the web server of the LT-3100S GMDSS system, by follow the instructions in *Accessing the built-in web server* on page 178. Select the 'Software update' web page and click the 'Choose File' button to select the LT-3100S GMDSS system file, which must be uploaded to the system. The software image has the following filename (example): LT-3100S-v1.04R-0012.Iti - the software image and release documentation will be available on the official company website: <https://www.thrane.eu>, under the specific product or in the Partner Area. Click the 'Upload' button to start the upload of the new software image. The upload and installation of the software image will take a few minutes. Progress indication bars can be monitored on the Software update webpage, while the software update is on-going. The LT-3100S GMDSS system will reboot once the software image is installed safely in all units. The LT-3100S GMDSS system will start up showing the Service Wizard, when the system has been software updated, see *Service Wizard* on page 76.

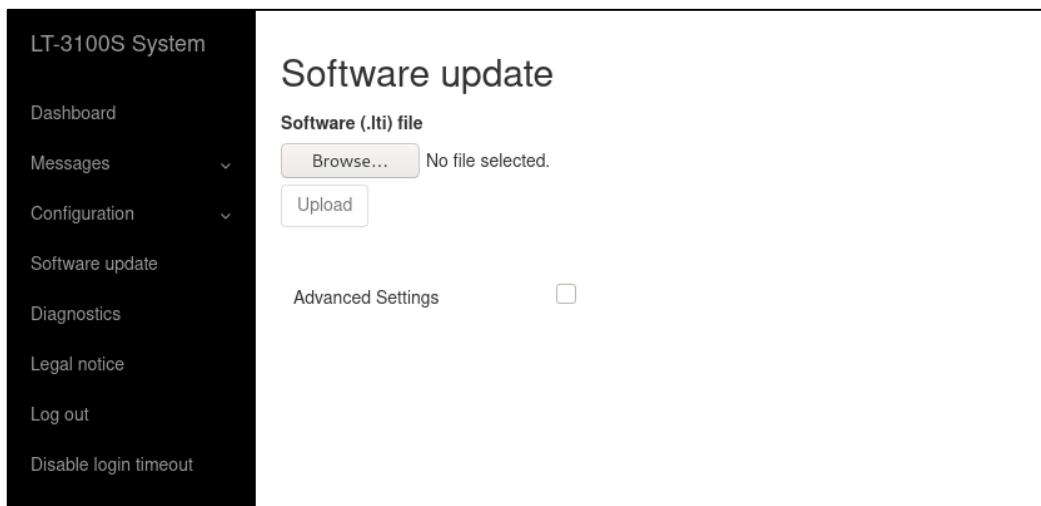

Figure 322: Web server (Software update)

NOTE: The LT-3110S Control Unit, LT-3130 Antenna Unit, and LT-3140S Interface Unit must be operated with the same software version. The software update will happen automatically, if the control unit identifies that the software version in the other units is different. Check or verify the web server Dashboard for software versions in each of the LT-3100S GMDSS system units, see *Dashboard* on page 179.

IMPORTANT: Do not remove power from the control unit or interface unit while the software update is on-going. Also, do not disconnect the antenna cable between the control unit and the antenna unit, while the software update is on-going.

IMPORTANT: The Advanced Settings shall not be used under normal circumstances. Do not use this function unless specifically instructed by Lars Thrane A/S or by GMDSS certified partner.

Diagnostic

A diagnostic report can be downloaded from the webpage ‘Diagnostics’. Navigate to the webpage and press the ‘Download diagnostics report’ button. A file with the following filename (example): LT-3100S_00000061_191115-152149.tar.gz will be downloaded to a location selected by the user. The Diagnostics Report can be sent back to Lars Thrane A/S in case of required support and assistance. The Diagnostics Report contains data describing the current state of the system and historical events. The data can be used by support to identify issues and determine their cause.

To help identifying a potential problem with the LT-3100S GMDSS system it is very important that the Diagnostic Report is sent back to Lars Thrane A/S.

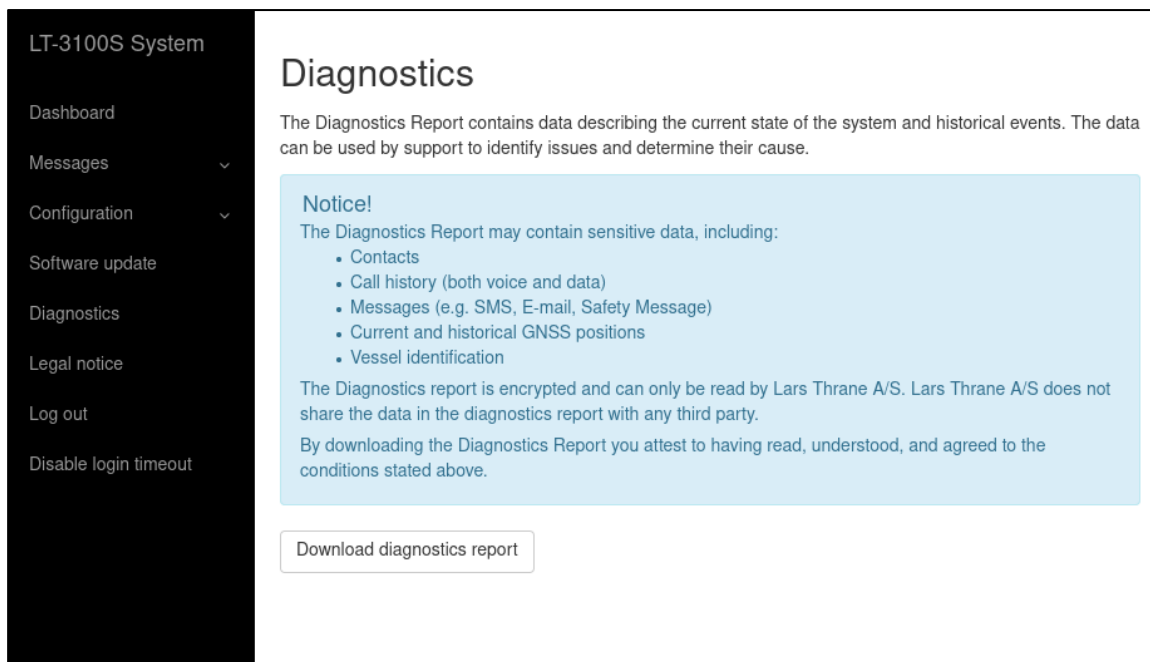

Figure 323: Web server (download diagnostics report)

NOTE: The diagnostic report is encrypted and can only be read by Lars Thrane A/S. Lars Thrane A/S does not share the data in the diagnostics report with any third party. By downloading and sending the diagnostic report to Lars Thrane A/S you attest to having read, understood, and agreed to the conditions stated under the Notice! (highlighted in Figure 323 above).

Legal notice

The LT-3100S GMDSS system contains Open Source software components. The Open Source software components used and related license information can be viewed by pressing the link 'here' under the Legal notice webpage, see Figure 324.

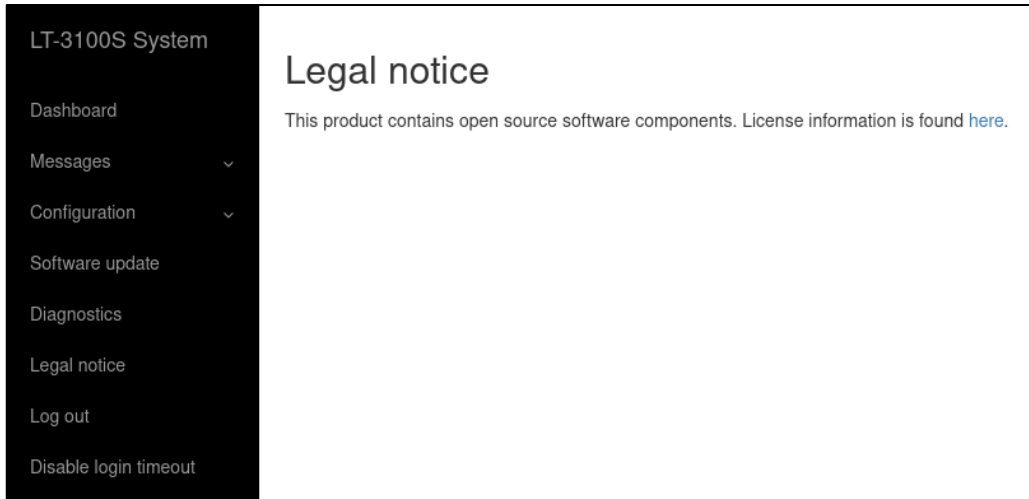

Figure 324: Web server (legal notice)

Log out

By pressing the 'Log out' webpage the web server will redirect you to the Authentication login, where it is required to use the Username and Password to re-enter the web server again. The Authentication is described in *Authentication* on page 183.

Disable login timeout

The web server will automatically logout after 5 minutes without activity. The user can disable this automatic logout by pressing the 'Disable login timeout' webpage, which then will change to a red color and text: 'Enable login timeout'. The user must manually remove this configuration by pressing the webpage to go back to default settings and automatically logout.

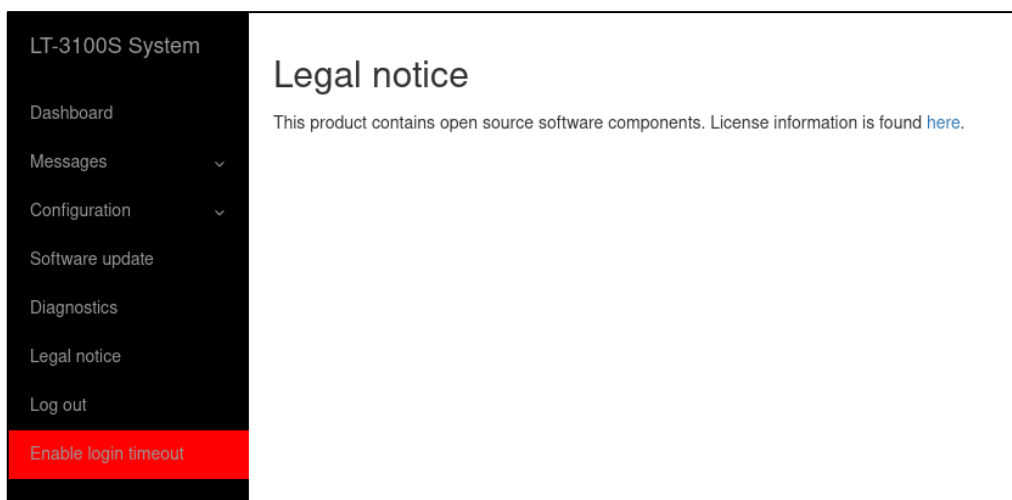

Figure 325: Web server (disable login timeout)

Service & Repair

This section describes what the end-user must do in case of required service or repair.

NOTE: The LT-3100S GMDSS system does not require any scheduled maintenance or service. Make sure that the product is installed, as described in this manual, before making contact to the distributor or dealer for further assistance.

If the LT-3100S GMDSS system for some reason does not work as described in this manual, contact the distributor or dealer, from where the product was originally bought. The distributor or dealer will have experience and know-how to assist with further technical support and troubleshooting.

Contact your GMDSS Partner:

- 1) Make sure to have the product name, unit part numbers, and unit serial numbers identified. The unit part numbers, and the unit serial numbers are identified on the unit label, which is found on the backside, or at the bottom side of the units. Alternatively, use the built-in web server to read-out the unit part numbers, and the unit serial numbers
- 2) Write a technical report about the observation or error. If possible, attach a picture of the installed product and include a wiring diagram. If possible, download a diagnostic report as described in *Diagnostic* on page 203
- 3) Send all information to the official LT GMDSS Partner

IMPORTANT: Unless otherwise agreed, the end-user shall always coordinate service and repair issues directly with the LT GMDSS Partner. This practice also applies for returning of products for service and repair.

All information that will get back to Lars Thrane A/S, either directly or indirectly, will be handled with confidentiality. End-user sensitive data will not be shared with any third party without prior written acceptance from the involved parties.

Appendixes

App. A - Applicable Standards

- [1] IEC 61097-16, Edition 1.0, 2019-07
Global maritime distress and safety system (GMDSS)
Part 16: Ship earth stations operating in mobile-satellite systems recognized for use in the GMDSS
Operational and performance requirements, methods of testing and required test results
- [2] IEC 61162-1, Edition 5.0, 2016-08
Maritime navigation and radiocommunication equipment and systems - Digital interfaces
Part 1: Single talker and multiple listeners
- [3] IEC 61162-2, Edition 1.0, 1998-09
Maritime navigation and radiocommunication equipment and systems - Digital interfaces
Part 2: Single talker and multiple listeners, high-speed transmission
- [4] IEC 61162-450, Edition 2.0, 2018-05
Maritime navigation and radiocommunication equipment and systems - Digital interfaces
Part 450: Multiple talkers and multiple listeners – Ethernet interconnection
- [5] IEC 62923-1, Edition 1.0, 2018-08
Maritime navigation and radiocommunication equipment and systems - Bridge alert management
Part 1: Operational and performance requirements, methods of testing and required test results
- [6] IEC 62923-2, Edition 1.0, 2018-08
Maritime navigation and radiocommunication equipment and systems - Bridge alert management
Part 2: Alert and cluster identifiers and other additional features

App. B - Bridge Alert Management (BAM)

Alert generating functions

The LT-3100S GMDSS system contains the following functions capable of raising alerts.

Name	Can be deactivated	Description
GMDSS	No	Responsible for all GMDSS services (Distress Alert & Distress Call, Distress Alert Relay, MSI, Safety Voice, Safety Messaging). It is not possible to deactivate this function.
GNSS Position	Yes	The system can be configured to use either GNSS position (automatic) or manual position. Alerts of the disabled mode will be cleared.
Manual Position	Yes	
SIM	No	Responsible for managing the Subscriber Identity Module (SIM) card. It is not possible to deactivate this function.

Table 53: Alert generating functions

Alert categories

The BAM concept groups alerts into categories as a mean to indicate where an alert may be acknowledged (and thus also whether it can have its responsibility transferred):

Category	Description
A	Alert for which additional information at the alert source is necessary, as decision support for the evaluation of the alert related condition. Alert can only be acknowledged at the alert source.
B	Alert where no additional information for decision support is necessary besides the information which can be presented at the CAM UI. Alert may be acknowledged at the alert source and/or the CAM system.
C	Alert that cannot be acknowledged on the bridge but for which information is required about the status and treatment of the alert.

Table 54: BAM alert categories

List of alerts

ID:	3013	Priority:	Caution	Category:	B
Title:	Doubtful pos				
Description:	GMDSS update manual position				
What to do:	Update the manual position as described in <i>Position Settings</i> on page 117.				
Conditions:	Raised in manual position mode if manually set position is older than 4 hours. Rectified upon update of manual position. Cleared to normal if position mode is set to automatic.				

ID:	3016	Priority:	Caution	Category:	B
Title:	Lost position				
Description:	Check GMDSS terminal for lost position				
What to do:	Change to manual position mode as described in <i>Position Settings</i> on page 117.				
Conditions:	Raised in automatic (GNSS) position mode if position is lost and stay lost for a minimum of 10 minutes. Rectified if GNSS receiver obtains a valid position. Cleared to normal if position mode is set to manual.				

ID:	3062	Priority:	Warning	Category:	B	Resp. transfer:	Yes
Title:	System fault			Can ACK:	Yes	Transitory:	No
Description:	System self-check error. Try power-cycle system						
What to do:	Power-cycle the system. If that does not help, contact the service provider.						
Conditions:	Raised when the system self-check detects an unspecified internal error.						
Escalation:	Repeated as a warning after 90 s.						

ID:	3062	Priority:	Warning	Category:	B	Resp. transfer:	Yes
Title:	Printer fault		Can ACK:	Yes	Transitory:	No	
Description:	Check GMDSS printer						
What to do:	<p>Check printer is online / selected. If offline / deselected, bring it back online / re-select it.</p> <p>If above does not resolve the issue, consult the manual of the printer.</p>						
Conditions:	<p>Raised when the system self-check detects an unspecified printer error or if the printer has been put offline / deselected for 60 seconds or more.</p>						
Escalation:	Repeated as a warning after 90 s.						

ID:	3079	Priority:	Caution	Category:	B		
Title:	Paper low						
Description:	Check GMDSS printer paper						
What to do:	Replace / refill printer paper.						
Conditions:	<p>Raised when printer is out of paper.</p> <p>Rectified when printer has been filled with new paper.</p> <p>Cleared to normal if printing to printer is disabled as described in <i>GMDSS Printer</i> on page 176.</p>						

ID:	3116	Priority:	Caution	Category:	B		
Title:	Lost connection						
Description:	Check GMDSS satellite terminal						
What to do:	<p>Verify the Antenna Unit has free line of sight to the sky. Remove any object blocking the line of sight if possible.</p>						
Conditions:	<p>Raised when the terminal has been unable to detect or otherwise contact the satellites of the Iridium® satellite system for a period of one minute or more.</p> <p>Rectified when the terminal detects the Iridium® satellite system.</p>						

ID:	3116	Priority:	Caution	Category:	B
Title:	Impaired radio				
Description:	MSI / Safety Message reception delayed				
What to do:	Verify the Antenna Unit has free line of sight to the sky. Remove any object blocking the line of sight if possible.				
Conditions:	<p>Raised when the terminal has been informed by the Iridium® network about new message(s) ready for download by the terminal but the terminal has failed to do so 3 times in a row.</p> <p>Rectified when the terminal has successfully downloaded the message(s).</p>				

ID:	3116	Priority:	Caution	Category:	B
Title:	Impaired radio				
Description:	Reception of MSI delayed. MSI list is outdated				
What to do:	Verify the Antenna Unit has free line of sight to the sky. Remove any object blocking the line of sight if possible.				
Conditions:	<p>Raised when the terminal has been instructed by the Iridium® network to download MSI messages or Safety Messages pending for the terminal but have failed to do so 3 times in a row.</p> <p>Rectified when the terminal successfully downloads the messages.</p>				

ID:	3122	Priority:	Warning	Category:	A	Resp. transfer:	Yes
Title:	Distress Rx			Can ACK:	No	Transitory:	No
Description:	Incoming distress. Check GMDSS display						
What to do:	Read the received Distress Alert Relay (see <i>Maritime Safety Information (MSI)</i> on page 88).						
Conditions:	<p>Raised when a Distress Alert Relay message is received.</p> <p>Rectified when all Distress Alert Relay messages have been read.</p>						
Escalation:	Repeated as a warning after 90 s.						
Other:	In case of reception of multiple Distress Alert Relay messages, only one alert is raised.						

ID:	3122	Priority:	Warning	Category:	A	Resp. transfer:	Yes
Title:	Urgency Rx		Can ACK:	No	Transitory:	No	
Description:	Incoming urgency warning. Check GMDSS display						
What to do:	Read the received urgency MSI message or urgency priority message (see <i>Maritime Safety Information (MSI)</i> on page 88 and <i>Safety Messaging</i> on page 97).						
Conditions:	Raised when an urgency MSI message or urgency priority message is received. Rectified when all MSI messages and priority message of severity urgency have been read.						
Escalation:	Repeated as a warning after 90 s.						
Other:	In case of reception of multiple urgency messages, only one alert is raised.						

ID:	3122	Priority:	Warning	Category:	A	Resp. transfer:	Yes
Title:	Distress missed		Can ACK:	No	Transitory:	No	
Description:	Missed distress call. Check GMDSS display						
What to do:	Open the Call History to see the details on the missed call.						
Conditions:	Raised when an incoming distress priority voice call was not answered. Rectified when the Call History is accessed.						
Escalation:	Repeated as a warning after 90 s.						
Other:	In case of multiple missed calls, only one alert is raised.						

ID:	3122	Priority:	Warning	Category:	A	Resp. transfer:	Yes
Title:	Urgency missed		Can ACK:	No	Transitory:	No	
Description:	Missed urgency call. Check GMDSS display						
What to do:	Open the Call History to see the details on the missed call.						
Conditions:	Raised when an incoming urgency priority voice call was not answered. Rectified when the Call History is accessed.						
Escalation:	Repeated as a warning after 90 s.						
Other:	In case of multiple missed calls, only one alert is raised.						

ID:	3123	Priority:	Caution	Category:	B
Title:	MSI Rx				
Description:	Check new received maritime safety information				
What to do:	Read the received MSI message (see <i>Maritime Safety Information (MSI)</i> on page 88).				
Conditions:	Raised when a safety MSI message is received. Rectified when all MSI messages of severity safety have been read.				
Other:	In case of reception of multiple safety messages, only one alert is raised.				

ID:	3123	Priority:	Caution	Category:	B
Title:	Safety Rx				
Description:	Check new received safety message				
What to do:	Read the received priority message (see <i>Safety Messaging</i> on page 97).				
Conditions:	Raised when a safety priority message is received. Rectified when all priority messages of severity safety have been read.				
Other:	In case of reception of multiple safety messages, only one alert is raised.				

ID:	3123	Priority:	Caution	Category:	B
Title:	Safety missed				
Description:	Missed safety call. Check GMDSS display				
What to do:	Open the Call History to see the details on the missed call.				
Conditions:	Raised when an incoming safety priority voice call was not answered. Rectified when the Call History is accessed.				
Other:	In case of multiple missed calls, only one alert is raised.				

ID:	11402	Priority:	Warning	Category:	B	Resp. transfer:	Yes
Title:	Invalid antenna			Can ACK:	Yes	Transitory:	No
Description:	GMDSS unavailable. Incompatible antenna						
What to do:	Replace the Antenna Unit with a compatible one (HW revision >= 2.00).						
Conditions:	Raised when the Control Unit detects an incompatible Antenna Unit revision.						
Escalation:	Repeated as a warning after 90 s.						
Other:	In case of multiple missed calls, only one alert is raised.						

ID:	11412	Priority:	Warning	Category:	B	Resp. transfer:	Yes
Title:	Lost handset			Can ACK:	Yes	Transitory:	No
Description:	Voice calls unavailable. Check handset cable						
What to do:	Check the cable between the handset and the Control Unit.						
Conditions:	Raised when Control Unit loose connection with the Handset. Rectified when connection is reestablished with the Handset.						
Escalation:	Repeated as a warning after 90 s.						

ID:	11412	Priority:	Warning	Category:	B	Resp. transfer:	Yes
Title:	Lost antenna			Can ACK:	Yes	Transitory:	No
Description:	GMDSS unavailable. Check antenna cable						
What to do:	Check the cable between the Control Unit and the Antenna Unit.						
Conditions:	Raised when Control Unit loose connection with the Antenna Unit. Rectified when connection is reestablished with the Antenna Unit.						
Escalation:	Repeated as a warning after 90 s.						

ID:	11412	Priority:	Warning	Category:	B	Resp. transfer:	Yes
Title:	Lost unit			Can ACK:	Yes	Transitory:	No
Description:	Interface unit lost. Check cable						
What to do:	Check the cable between the Control Unit and the Interface Unit and that the Interface Unit has power. The Interface Unit may have a separate power supply from the Control Unit.						
Conditions:	Raised when Control Unit loose connection with the Interface Unit. Rectified when connection is reestablished with the Interface Unit.						
Escalation:	Repeated as a warning after 90 s.						

ID:	11412	Priority:	Warning	Category:	B	Resp. transfer:	Yes
Title:	Lost panel		Can ACK:	Yes	Transitory:	No	
Description:	Alarm panel lost. Check alarm panel cable						
What to do:	Check the cable between the Interface Unit and the Alarm Panel(s).						
Conditions:	Raised when Interface Unit loose connection with an Alarm Panel. Rectified when connection is reestablished with the Alarm Panel.						
Escalation:	Repeated as a warning after 90 s.						
Other:	In case connection is lost to multiple Alarm Panels, only one alert is raised.						

ID:	11412	Priority:	Warning	Category:	B	Resp. transfer:	Yes
Title:	Lost adapter		Can ACK:	Yes	Transitory:	No	
Description:	Printer adapter lost. Check adapter cable						
What to do:	Check the cable between the Interface Unit and the Printer Adapter.						
Conditions:	Raised when Interface Unit loose connection with the Printer Adapter. Rectified when connection is reestablished with the Printer Adapter.						
Escalation:	Repeated as a warning after 90 s.						

ID:	11412	Priority:	Warning	Category:	B	Resp. transfer:	Yes
Title:	Lost printer		Can ACK:	Yes	Transitory:	No	
Description:	Check printer and cable						
What to do:	Check the Printer Adapter is connected to the Printer. Check the Printer is powered on.						
Conditions:	Raised when Printer Adapter loses connection with the Printer. Rectified when connection is reestablished with the Printer.						
Escalation:	Repeated as a warning after 90 s.						

ID:	15102	Priority:	Warning	Category:	B	Resp. transfer:	Yes
Title:	Lost SIM card		Can ACK:	Yes	Transitory:	No	
Description:	GMDSS unavailable. Check SIM card						
What to do:	Verify the SIM card is properly inserted (see <i>GMDSS SIM card (SIM)</i> on page 34).						
Conditions:	Raised when the SIM card is removed or cannot be detected. Rectified when the SIM card is detected.						
Escalation:	Repeated as a warning after 90 s.						

ID:	21102	Priority:	Warning	Category:	B	Resp. transfer:	Yes
Title:	GMDSS fault		Can ACK:	Yes	Transitory:	No	
Description:	GMDSS terminal rejected by Iridium network						
What to do:	Contact your service provider.						
Conditions:	Raised when the terminal is rejected by the Iridium® network.						
Escalation:	Repeated as a warning after 90 s.						

ID:	21102	Priority:	Warning	Category:	B	Resp. transfer:	Yes
Title:	GMDSS fault		Can ACK:	Yes	Transitory:	No	
Description:	GMDSS antenna rejected by Iridium network						
What to do:	Contact your service provider.						
Conditions:	Raised when the Antenna Unit is rejected by the Iridium® network.						
Escalation:	Repeated as a warning after 90 s.						

ID:	21102	Priority:	Warning	Category:	B	Resp. transfer:	Yes
Title:	GMDSS fault		Can ACK:	Yes	Transitory:	No	
Description:	GMDSS SIM card rejected by Iridium network						
What to do:	Contact your service provider.						
Conditions:	Raised when the SIM card is rejected by the Iridium® network.						
Escalation:	Repeated as a warning after 90 s.						

ID:	21202	Priority:	Warning	Category:	B	Resp. transfer:	Yes
Title:	Safety Tx fail		Can ACK:	Yes	Transitory:	Yes	
Description:	Failed to send safety message						
What to do:	Verify the Antenna Unit has free line of sight to the sky. Remove any object blocking the line of sight if possible. Then initiate resending of the message (see <i>Safety Messaging</i> on page 97).						
Conditions:	Raised when sending of a Safety Message permanently failed.						
Escalation:	Repeated as a warning after 90 s.						
Other:	In case transmission of multiple safety messages fails, only one alert is raised.						

App. C - Multiple talkers and multiple listeners

IEC 61162 *Multiple talkers and multiple listeners* is a series of protocol definitions supporting both RS-422 and Ethernet for transporting its messages.

LT-3100S GMDSS system currently supports IEC 61162 over RS-422 only but is prepared for future support of IEC 61162 over Ethernet. Certification of compliance with IEC 61162-450 and IEC 61162-460 has been obtained and thus the LT-3100 GMDSS system is permitted to be connected to an IEC 61162 Ethernet network, though none of their functions are supported.

ONF network node

The LT-3100S GMDSS system is classified as an ONF network node by IEC 61162 using the following protocols: DHCP, IPv4, IPv4LL, UDP, TCP, SIP, RTP, HTTP, HTTPS, RFC 2217.

App. D - GNSS sentences

This appendix provides detailed information about the GNSS sentences supported by the LT-3100S GMDSS system. For further details see *GNSS sentences* on page 173 and web server configuration *GNSS, BAM and MSI* on page 197.

GNSS Talker identification mnemonics

The LT-3100S GMDSS system may use the following talker identifiers:

GNSS Talker Identification Mnemonics		
Talker Device	Identifier	Function
Global Navigation Satellite System (GNSS)	GN	GNSS
Global Positioning System (GPS)	GP	GNSS
GLONASS positioning system	GL	GNSS
BeiDou positioning system	GB	GNSS

Table 55: GNSS Talker identification mnemonics

GNSS Talker Sentence Overview

The table below lists all GNSS sentences the LT-3100S GMDSS system can transmit (as a talker):

GNSS Talker Sentences			
Sentence Formatter	Function	Description	Transmission Interval
DTM	GNSS	Datum reference	1 s
GGA	GNSS	Global positioning system (GPS) fix data	1 s
GLL	GNSS	Geographic position – latitude / longitude	1 s
GSA	GNSS	GNSS DOP and active satellites	1 s
GSV	GNSS	GNSS satellites in view	1 s
RMC	GNSS	Recommended minimum specific GNSS data	1 s
VTG	GNSS	Course over ground and ground speed	1 s
ZDA	GNSS	Time and date	1 s

Table 56: GNSS Talker Sentences

GNSS Listener sentences overview

No listener sentences available for GNSS.

GNSS Talker sentences

```
$--DTM,ccc,a,x.x,a,x.x,a,x.x,ccc*hh<CR><LF>
```

```
$--GGA,hhmmss.ss,1111.11,a,yyyy.yy,a,x,xx,x.x,x.x,M,x.x,M,x.x,xxxx*hh<CR><LF>
```

NOTE: The "Age of differential GPS data" field (no. 13) is always null.

```
$--GLL,1111.11,a,yyyy.yy,a,hhmmss.ss,A,a*hh<CR><LF>
```

```
$--GSA,a,x,xx,xx,xx,xx,xx,xx,xx,xx,xx,xx,xx,x.x,x.x,x.x,h*hh<CR><LF>
```

```
$--GSV,x,x,xx,xx,xx,xxx,xx.....,xx,xx,xxx,xx,h*hh<CR><LF>
```

```
$--RMC,hhmmss.ss,A,1111.11,a,yyyy.yy,a,x.x,x.x,xxxxxx,x.x,a,a,a*hh<CR><LF>
```

NOTE: The "Magnetic variation" fields (no. 10 and 11) are always null.

```
$--VTG,x.x,T,x.x,M,x.x,N,x.x,K,a*hh<CR><LF>
```

NOTE: The "Course over ground, degrees magnetic" field (no. 3) is always null.

```
$--ZDA,hhmmss.ss,xx,xx,xxxx,xx,xx*hh<CR><LF>
```

GNSS Listener sentences

No listener sentences available for GNSS.

App. E - BAM sentences

This appendix provides detailed information about the BAM sentences supported by the LT-3100S GMDSS system. For further details see *BAM sentences* on page 174 and web server configuration *GNSS, BAM and MSI* on page 197.

BAM Talker identification mnemonics

The LT-3100S GMDSS system may use the following talker identifiers:

BAM Talker Identification Mnemonics		
Talker Device	Identifier	Function
Communications - satellite	CS	BAM

Table 57: BAM talker identification mnemonics

BAM Talker Sentence Overview

The table below lists all BAM sentences the LT-3100S GMDSS system can transmit (as a talker):

BAM Talker Sentences			
Sentence Formatter	Function	Description	Transmission Interval
ALC	BAM	Cyclic alert list	30 s
ALF	BAM	Alert sentence	n/a
ARC	BAM	Alert command refused	n/a

Table 58: BAM talker sentences

BAM Listener sentences overview

The table below lists all sentences the LT-3100S GMDSS system can receive (as a listener):

BAM Listener Sentences			
Sentence Formatter	Function	Description	Presence
ACN	BAM	Alert command	Optional
HBT	BAM	Heartbeat supervision sentences	Optional

Table 59: BAM listener sentences

BAM talker sentences

```
$--ALC,xx,xx,xx,x.x,aaa,x.x,x.x,x.x,.....,aaa,x.x,x.x,x.x*hh<CR><LF>
```

```
$--ALF,x,x,x,hhmmss.ss,a,a,a,aaa,x.x,x.x,x.x,x,c---c*hh<CR><LF>
```

NOTE: If the UTC time was not known when the alert changed state, the “Time of last change” field (no. 4) is null.

```
$--ARC,hhmmss.ss,aaa,x.x,x.x,c*hh<CR><LF>
```

NOTE: If the UTC time was not known when the alert changed state, the “Time” field (no. 1) is null.

BAM listener sentences

```
$--ACN,hhmmss.ss,aaa,x.x,x.x,c,a*hh<CR><LF>
```

NOTE: The “Time” field (no. 1) is ignored and optional.

```
$--HBT,x.x,A,x*hh<CR><LF>
```

APP. F - MSI sentences

This appendix provides detailed information about the MSI sentences supported by the LT-3100S GMDSS system. For further details see *MSI sentences* on page 175 and web server configuration *GNSS, BAM and MSI* on page 197.

MSI talker identification mnemonics

The LT-3100S GMDSS system may use the following talker identifiers:

MSI Talker Identification Mnemonics		
Talker Device	Identifier	Function
Communications - satellite	CS	MSI

Table 60: MSI talker identification mnemonics

MSI talker sentence overview

The table below lists all MSI sentences the LT-3100S GMDSS system can transmit (as a talker):

MSI Sentences			
Sentence Formatter	Function	Description	Transmission Interval
SM1	MSI	SafetyNET message, all ships / NAVAREA	n/a
SM2	MSI	SafetyNET message, coastal warning area	n/a
SM3	MSI	SafetyNET message, circular area address	n/a
SM4	MSI	SafetyNET message, rectangular area address	n/a
SMB	MSI	SafetyNET message body	n/a
SMV	MSI	SafetyNET message, vessel in distress information	n/a

Table 61: MSI sentences

MSI listener sentences overview

No listener sentences available for MSI.

MSI talker sentences

```
$--SM1,A,x.x,xxxxxxx,xxx,x,x,xx,xx,xxxx,xx,xx,xx,xx,xx*hh
```

```
$--SM2,A,x.x,xxxxxxx,xxx,x,x,xx,xx,xxxx,xx,xx,xx,xx,xx,a,a*hh
```

```
$--SM3,A,x.x,xxxxxxx,xxx,x,x,xx,xx,xxxx,xx,xx,xx,xx,1111.11,a,yyyyy.yy,a,xxx*hh
```

```
$--SM4,A,x.x,xxxxxxx,xxx,x,x,xx,xx,xxxx,xx,xx,xx,xx,1111.11,a,yyyyy.yy,a,xx,xxx*hh
```

```
$--SMB,xxx,xxx,x,x.x,c--c*hh
```

```
$--SMV,x,x,x,x.x,xxxxxxxxxx,c--c,1111.11,a,yyyyy.yy,a,xxxx,xx,xx,xx,xx,a*hh
```

MSI listener sentences

No listener sentences available for MSI.

App. G - GNSS Receiver Integrity States (Automatic GNSS)

The LT-3100S GMDSS system has a built-in GNSS receiver located in the LT-3130 Antenna Unit. The GNSS receiver is used under normal conditions for providing the LT-3100S GMDSS system with time, data, and position information to all required functions in the system. The LT-3100S GMDSS system can be configured to the positions settings modes: 1) Automatic GNSS (default) or 2) Manual Input. Position Settings is located in the GMDSS submenu (MENU -> GMDSS -> Position Settings) described and illustrated in *Position Settings* on page 117. Position Status is located in the System submenu (MENU -> System) described and illustrated in *System* starting on page 161.

Table 62 illustrates the GNSS receiver integrity states in Automatic GNSS position mode. The color marking has the following meaning:

- Colored Yellow -> low integrity
- Colored Orange-> Invalid

GNSS Receiver Integrity States (Automatic GNSS)							
State	UTC	POSN	POSN (age)	Horizontal Accuracy	COG [°]	SOG [kts]	Comments
System has just booted and there is not yet a fix	Acquiring...	Acquiring...	-	-	-	-	System booting up
System has just booted and only time is known	Time	Acquiring...	-	-	-	-	System booting up
Horizontal accuracy > 50 m (SOG = 0 kts)	Time	Lat/Long	Up to date	> 50 m	XXX.X	XX.X	System booting up
Horizontal accuracy < 50 m (SOG = 0 kts)	Time	Lat/Long	Up to date	< 50 m	XXX.X	XX.X	Normal GNSS receiver state.
SOG > 1 m/s (~ 2 kts)	Time	Lat/Long	Up to date	< 50 m	XXX.X	XX.X	Normal GNSS receiver state.
GNSS fix completely lost (last known position has age > 0 min)	Time (old)	Lat/Long	> 0 min	-	-	-	No fix on GNSS receiver (time and position).
GNSS fix completely lost (last known position has age 23 hours 59 min)	Time (old)	Lat/Long	≤ 23 hours 59 min	-	-	-	No fix on GNSS receiver (time and position).
GNSS fix completely lost (last known position has age ≥ 24 hours)	Time (old)	Lat/Long Acquiring...	≥ 24 hours	-	-	-	No fix on GNSS receiver (time and position).

Table 62: GNSS Receiver Integrity States (Automatic GNSS)

Table 62 is illustrating the GNSS receiver integrity states in Automatic GNSS position mode. The following pages will illustrate all relevant states.

System has just booted and there is not yet a fix

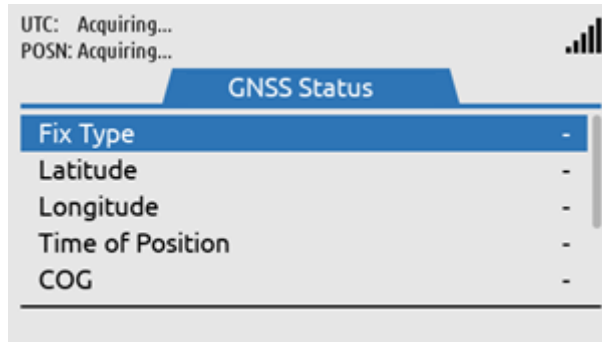

Figure 326: GNSS Receiver Integrity State

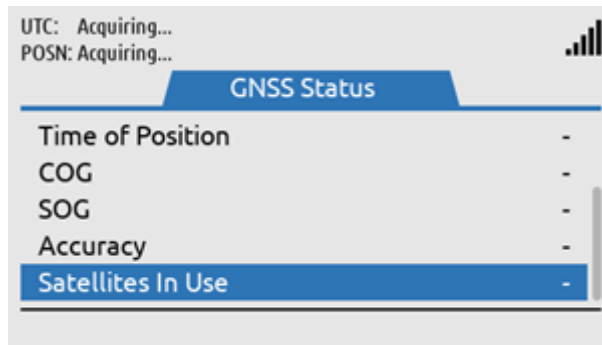

Figure 327: GNSS Receiver Integrity State

System has just booted and only time is known

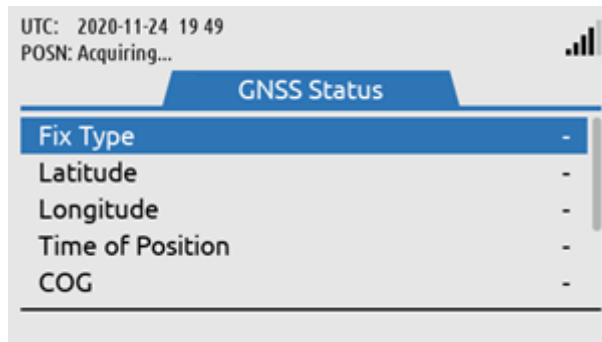

Figure 328: GNSS Receiver Integrity State

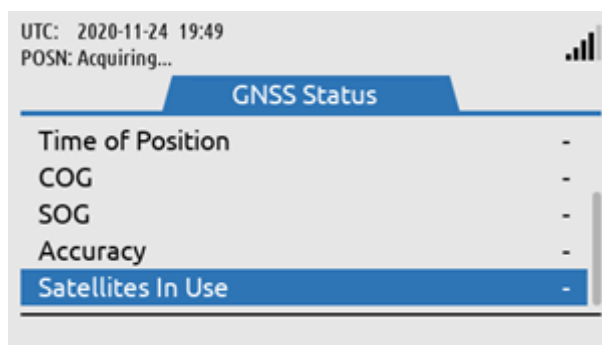

Figure 329: GNSS Receiver Integrity State

Horizontal accuracy > 50 m (SOG = 0 kts)

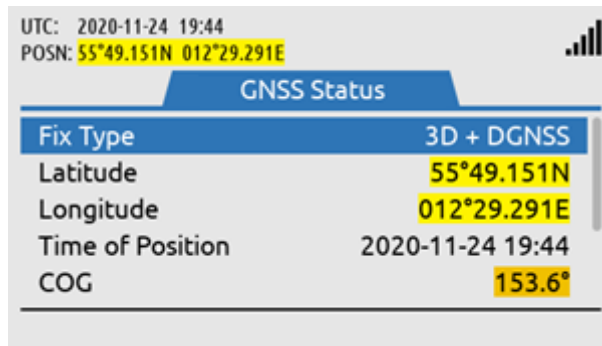

Figure 330: GNSS Receiver Integrity State

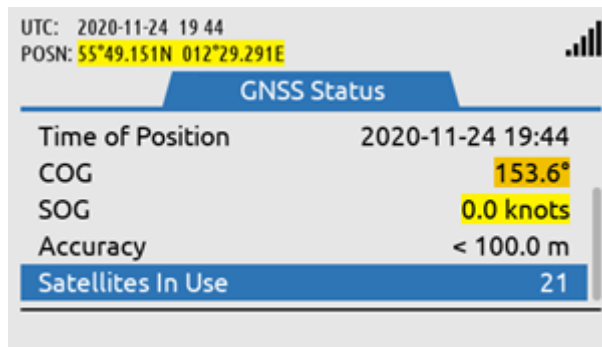

Figure 331: GNSS Receiver Integrity State

Horizontal accuracy < 50 m (SOG = 0 kts)

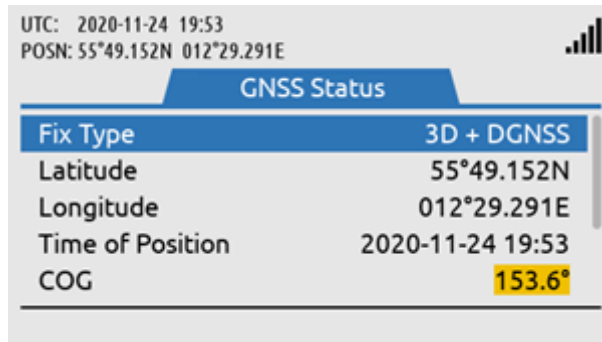

Figure 332: GNSS Receiver Integrity State

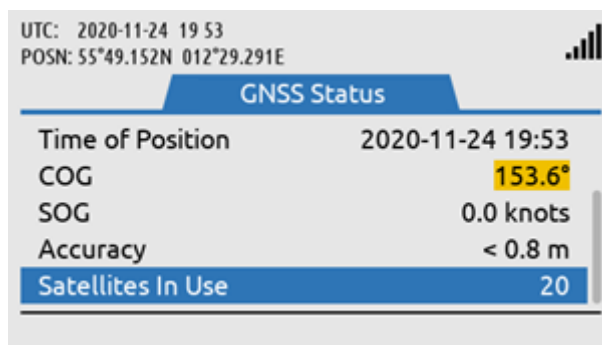

Figure 333: GNSS Receiver Integrity State

SOG > 1 m/s (~ 2 kts)

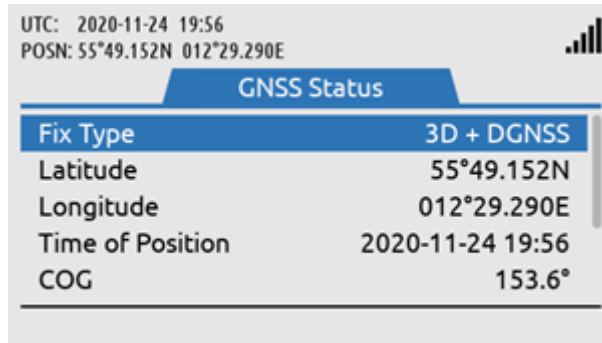

Figure 334: GNSS Receiver Integrity State

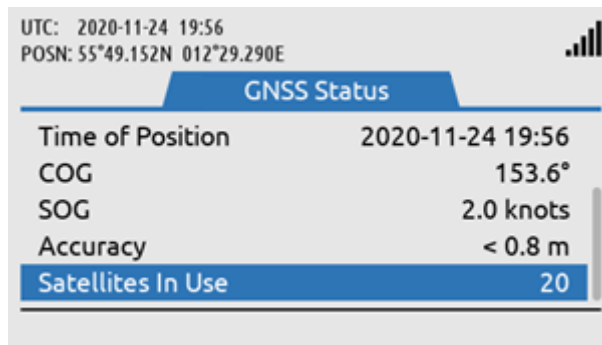

Figure 335: GNSS Receiver Integrity State

GNSS fix completely lost (last known position has age 10 min)

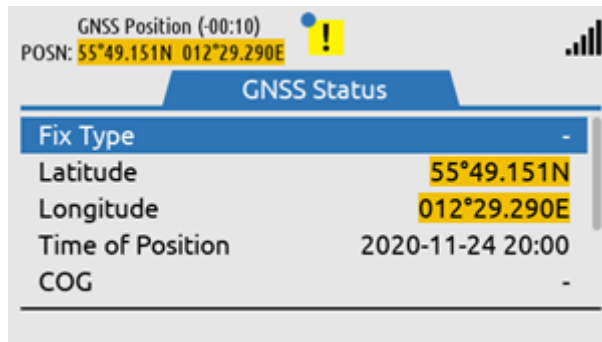

Figure 336: GNSS Receiver Integrity State

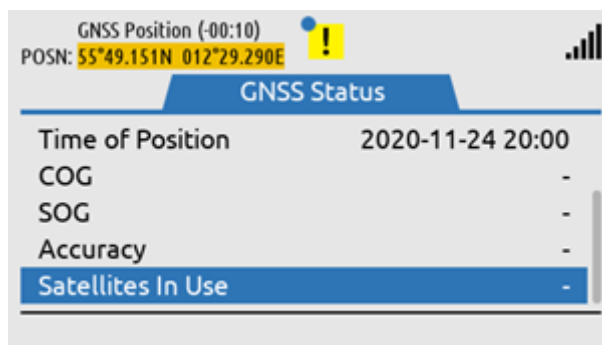

Figure 337: GNSS Receiver Integrity State

GNSS fix completely lost (last known position has age 23 hours 59 min)

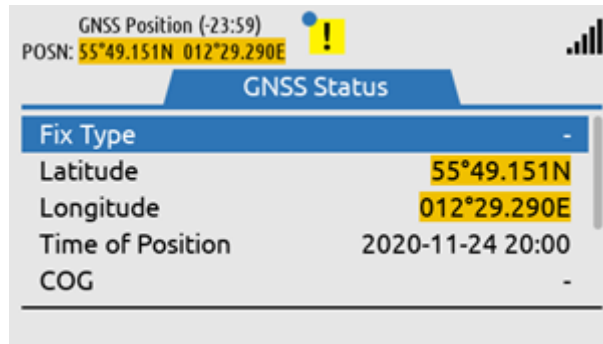

Figure 338: GNSS Receiver Integrity State

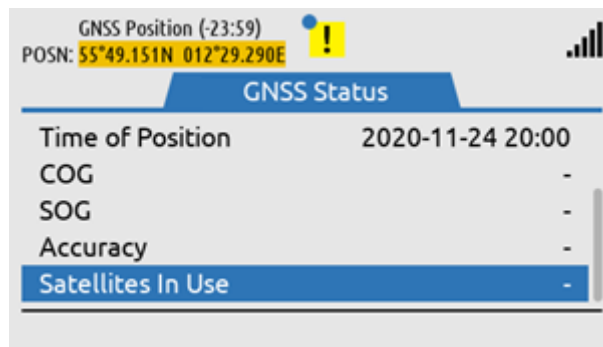

Figure 339: GNSS Receiver Integrity State

GNSS fix completely lost (last known position has age >= 24 hours)

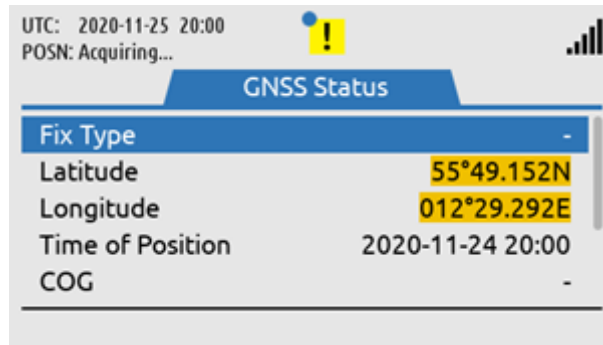

Figure 340: GNSS Receiver Integrity State

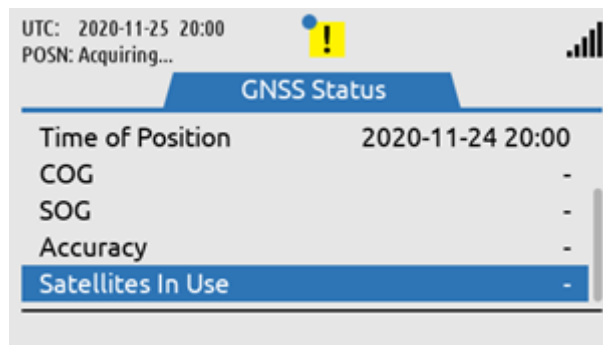

Figure 341: GNSS Receiver Integrity State

App. H - Specifications***LT-3100S GMDSS Satellite Communications System***

Certification & standards	Wheelmark Modul B and Module D, RED, FCC, ISED, RoHS 2, Iridium®
Vibration, operational	IEC 60945
Vibration, shock	Half sine 20 g/11 ms
Compass Safe Distance, std.	1.0 m (3.3 ft)
Compass Safe Distance, steer.	0.9 m (3.0 ft)
BAM EUT function types	P

LT-3110S Control Unit

Power consumption: operating mode, max	40.8 W
Weight	0.67 kg (1.48 lbs)
Dimensions	224.0 x 120.0 x 70.0 mm (8.82 x 4.72 x 2.76 in)
Temperature, operational	-15°C to +55°C (+5°F to +131°F)
IP rating, dust and water	IP32
Interfaces	Ethernet, auxiliary, DC input, chassis ground Antenna Unit (N conn.), handset, Bluetooth, SIM card
Input power	12-24 VDC (2.2-1.7 A)
BT transmitter, Max RF output power	10 mW
BT transmitter, Frequency bands	TX: 2402-2480MHz, RX:2402-2480MHz

LT-3120 Handset

Weight	0.30 kg (0.66 lbs)
Dimensions	52.8 x 208.8 x 38.2 mm (2.08 x 8.22 x 1.50 in)
Temperature, operational	-15°C to +55°C (+5°F to +131°F)
IP rating, dust and water	IP32

LT-3121 Cradle

Weight	0.07 kg (0.15 lbs)
Dimensions	106.9 x 57.4 x 29.3 mm (4.21 x 2.26 x 1.15 in)

LT-3130 Antenna Unit

Weight (without mount)	0.72 kg (1.59 lbs)
Dimensions	151.1 x Ø 149.5 mm (5.95 x Ø 5.89 in)
Temperature, operational (12 VDC input power)	-30°C to +55°C (-22°F to +131°F)
Temperature, operational (24 VDC input power)	-40°C to +55°C (-40°F to +131°F)
IP rating, dust and water	IP67
Interfaces	Control Unit (N conn.)
Iridium transmitter, Max RF output power	8 W
Iridium transmitter, Frequency bands	TX: 1616-1626,50MHz, RX: 1616-1626,50MHz
Antenna communication cable	Coaxial cable, up to 500 m (1500 ft)

App. H - Specifications (continued)***LT-3140S Interface Unit***

Power consumption: operating mode, max	10.0 W
Weight	0.71 kg (1.57 lbs)
Dimensions	227.0 x 186.0 x 40.0 mm (8.94 x 7.32 x 1.57 in)
Temperature, operational	-15°C to +55°C (+5°F to +131°F)
IP rating, dust and water	IP20
Interfaces	4 x Ethernet, 2 x RS-422, 4 x GPIO, 4 x CAN DC input, chassis ground
Input power	12-24 VDC (0.7-0.4 A)

LT-3150S Alarm Panel

Weight / Weight (incl. 25m cable)	0.07 kg (0.15 lbs) / 1.29 (2.84 lbs)
Dimensions	52.0 x 82.0 x 26.0 mm (2.05 x 3.23 x 1.02 in)
Temperature, operational	-15°C to +55°C (+5°F to +131°F)
IP rating, dust and water	IP30
Interfaces	1 x CAN

LT-3160S Printer Adapter

Weight / Weight (incl. 25m cable)	0.03 kg (0.07 lbs) / 1.25 kg (2.76 lbs)
Dimensions	62.1 x 68.1 x 19.4 mm (2.44 x 2.68 x 0.76 in)
Temperature, operational	-15°C to +55°C (+5°F to +131°F)
IP rating, dust and water	IP40
Interfaces	1 x CAN

Warranty	2 year
Maintenance	None

App. I - Outline Drawing: LT-3110S Control Unit

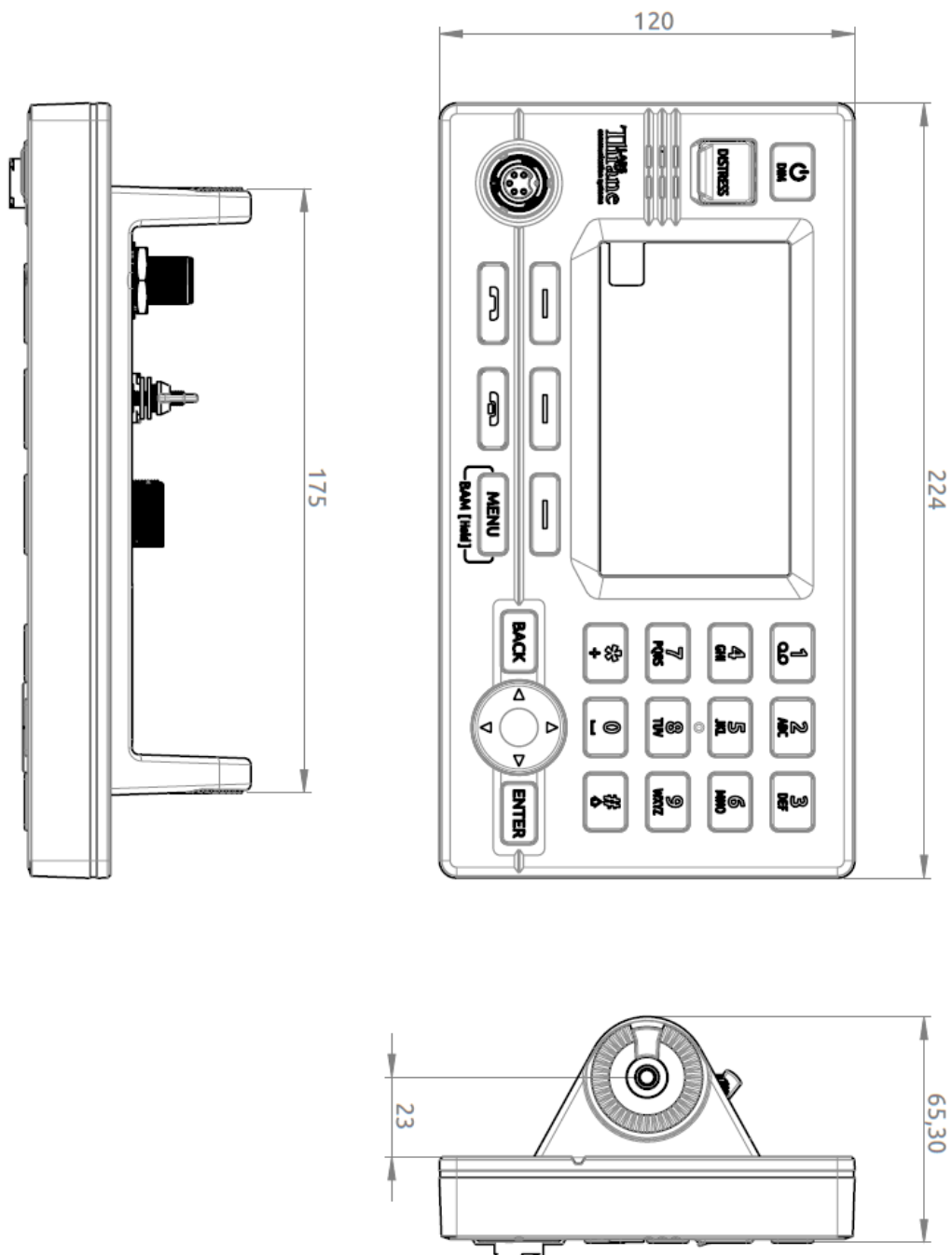

Figure 342: Outline Drawing: LT-3110S Control Unit

App. J - Outline Drawing: Bracket Mount, Control Unit

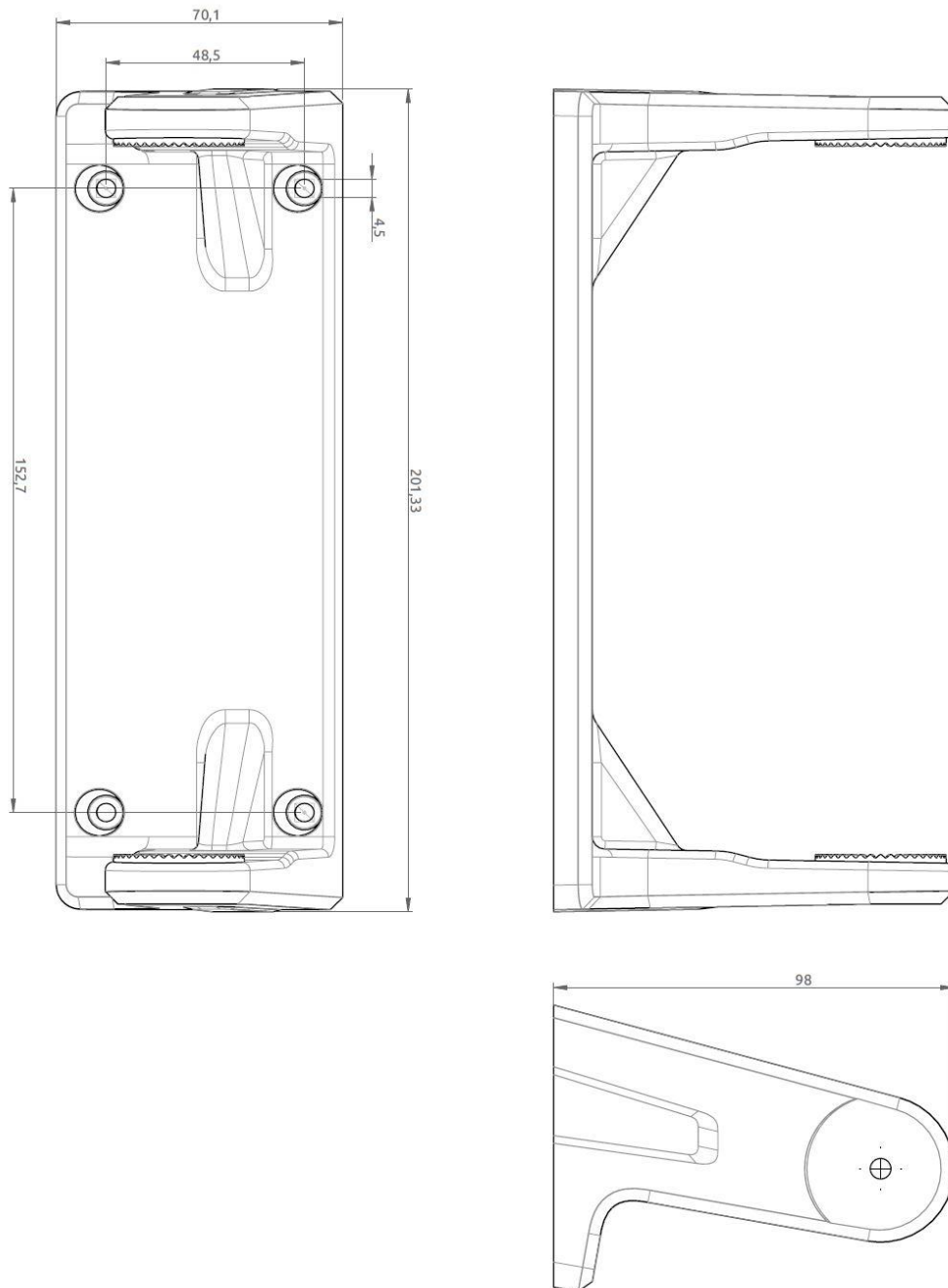

Figure 343: Outline Drawing: Bracket Mount, Control Unit

App. K - Outline Drawing: Flush Mount, Control Unit

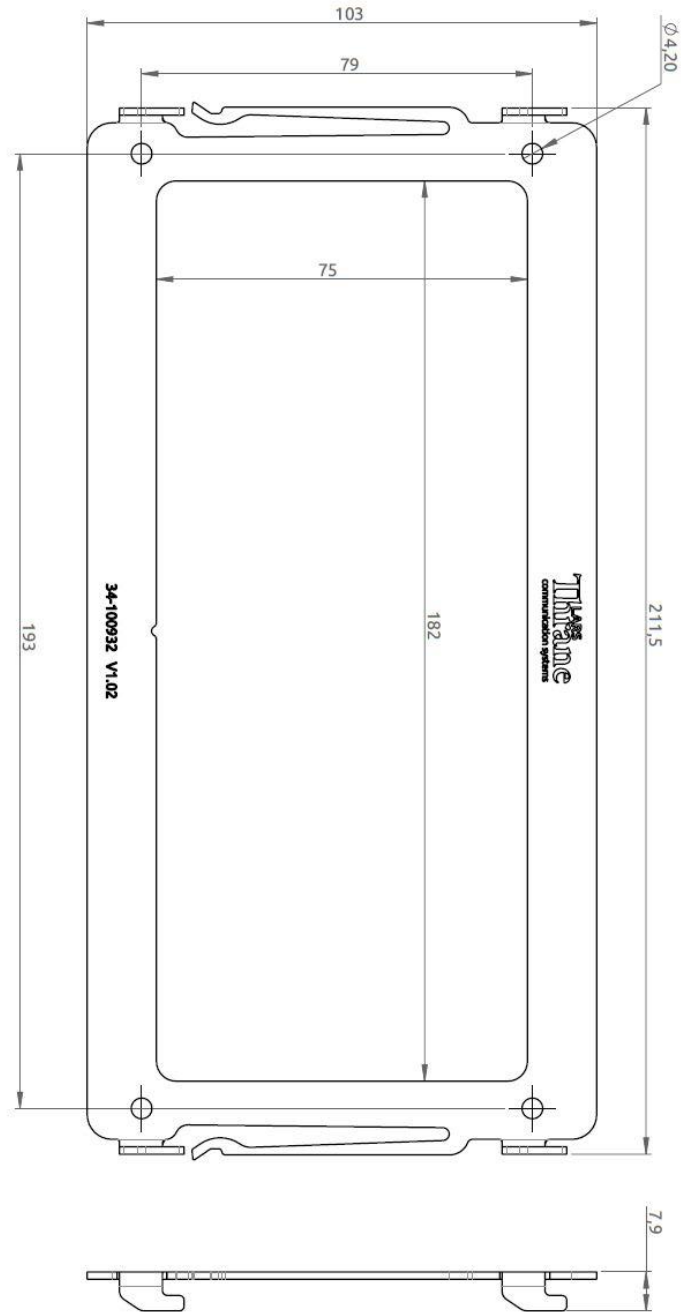

Figure 344: Outline Drawing: Flush Mount, Control Unit

App. L - Outline Drawing: LT-3130 Antenna Unit

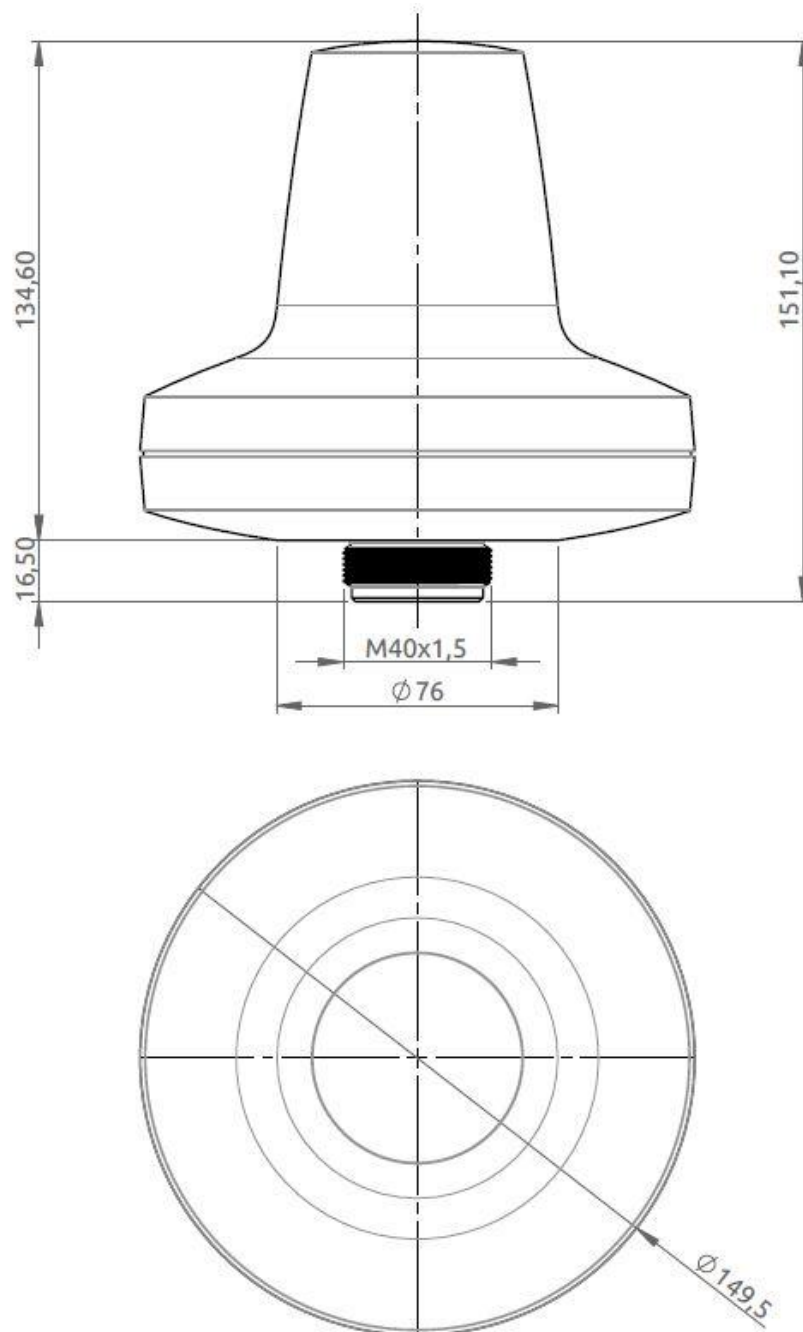

Figure 345: Outline Drawing: LT-3130 Antenna Unit

App. M - Outline Drawing: LT-3140S Interface Unit

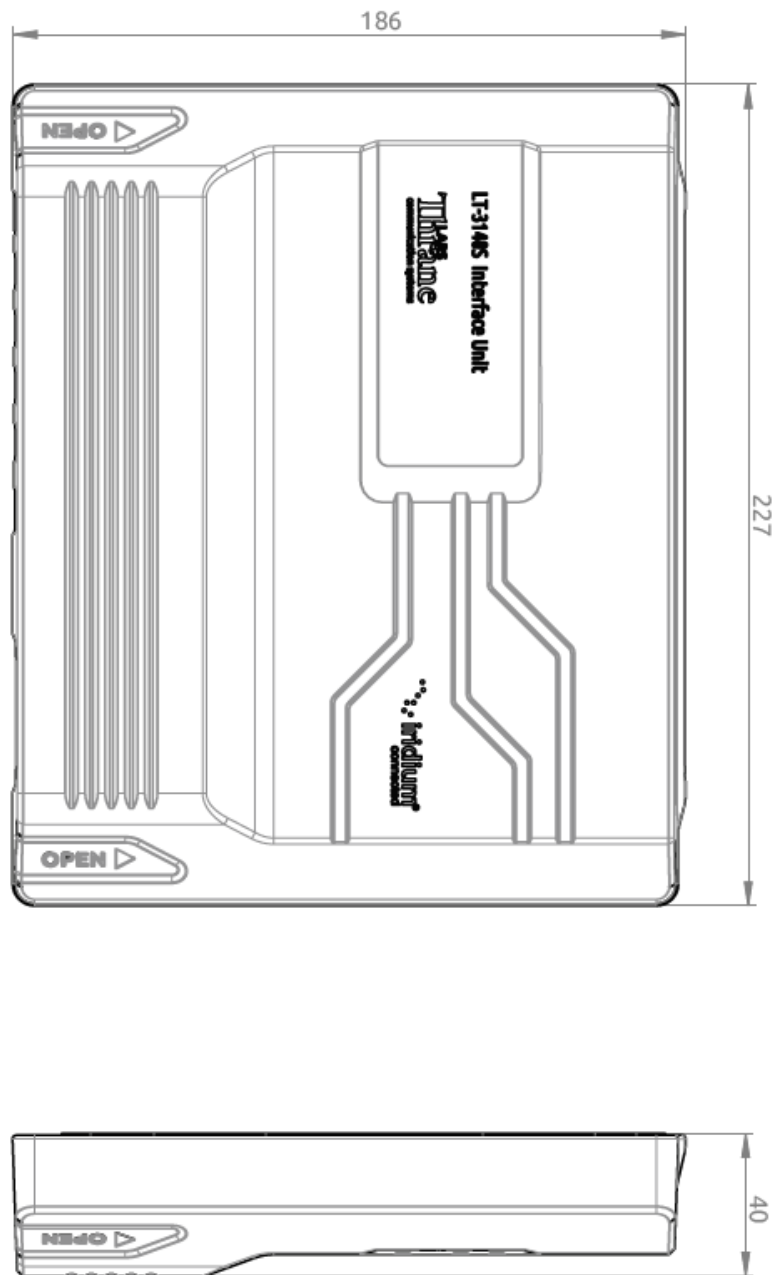

Figure 346: Outline Drawing: LT-3140S Interface Unit

App. N - Outline Drawing: LT-3150S Alarm Panel

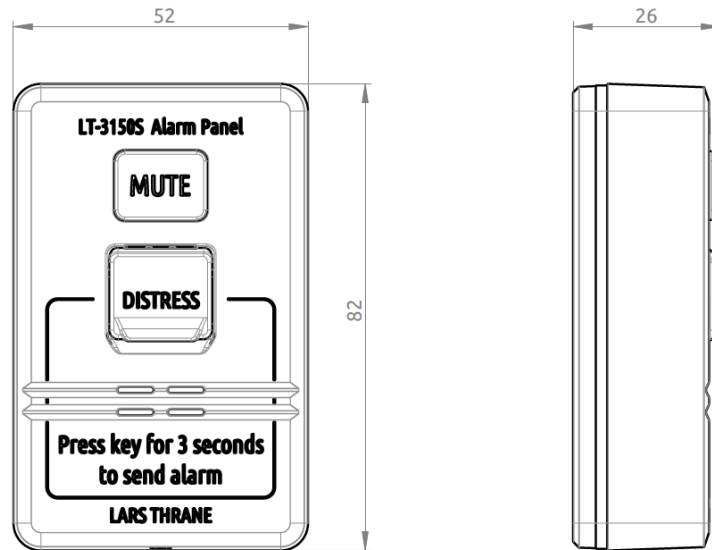

Figure 347: Outline Drawing: LT-3150S Alarm Panel

App. O - Outline Drawing: LT-3160S Printer Adapter

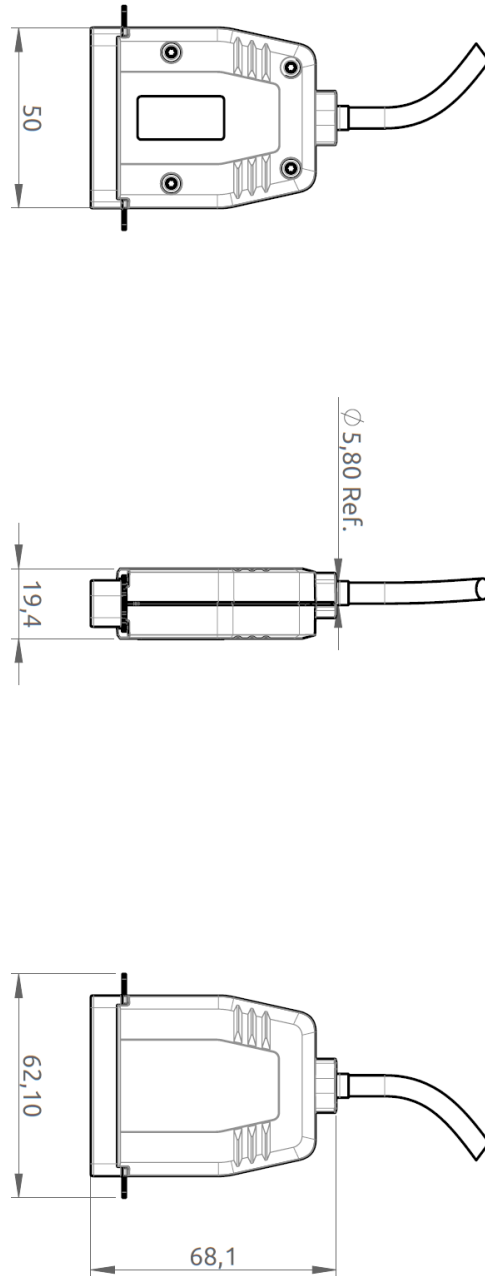

Figure 348: Outline Drawing: LT-3160S Printer Adapter

App. P - Outline Drawing: Pole Mount (1.5" pipe, 38.8 mm), Antenna Unit

NOTE: The Pole Mount (1.5" pipe, 38.8 mm), Antenna Unit interfaces to a pipe of maximum 1.5" (38.8 mm), measured outer diameter. The total weight of the Pole Mount is 0.18 kg (0.40 lbs).

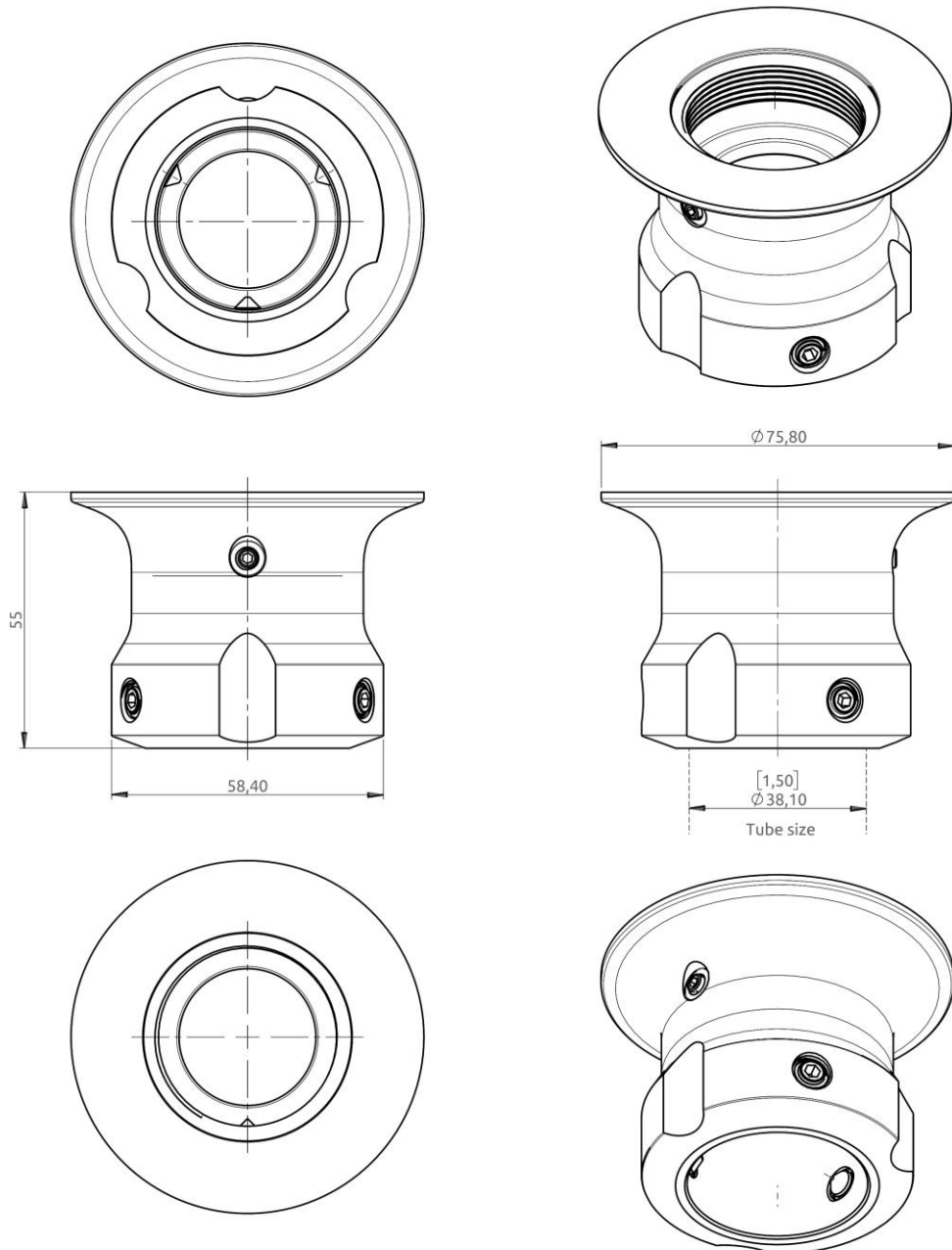

Figure 349: Outline Drawing: Pole Mount (1.5" pipe, $\varnothing 38.8$ mm), Antenna Unit

App. Q - Outline Drawing: Pole Mount (2.0" pipe, 53.0 mm), Antenna Unit

NOTE: The Pole Mount (2.0" pipe, 53.0 mm), Antenna Unit interfaces to a pipe of maximum 2.0" (53.0 mm), measured outer diameter. The total weight of the Pole Mount is 0.24 kg (0.53 lbs).

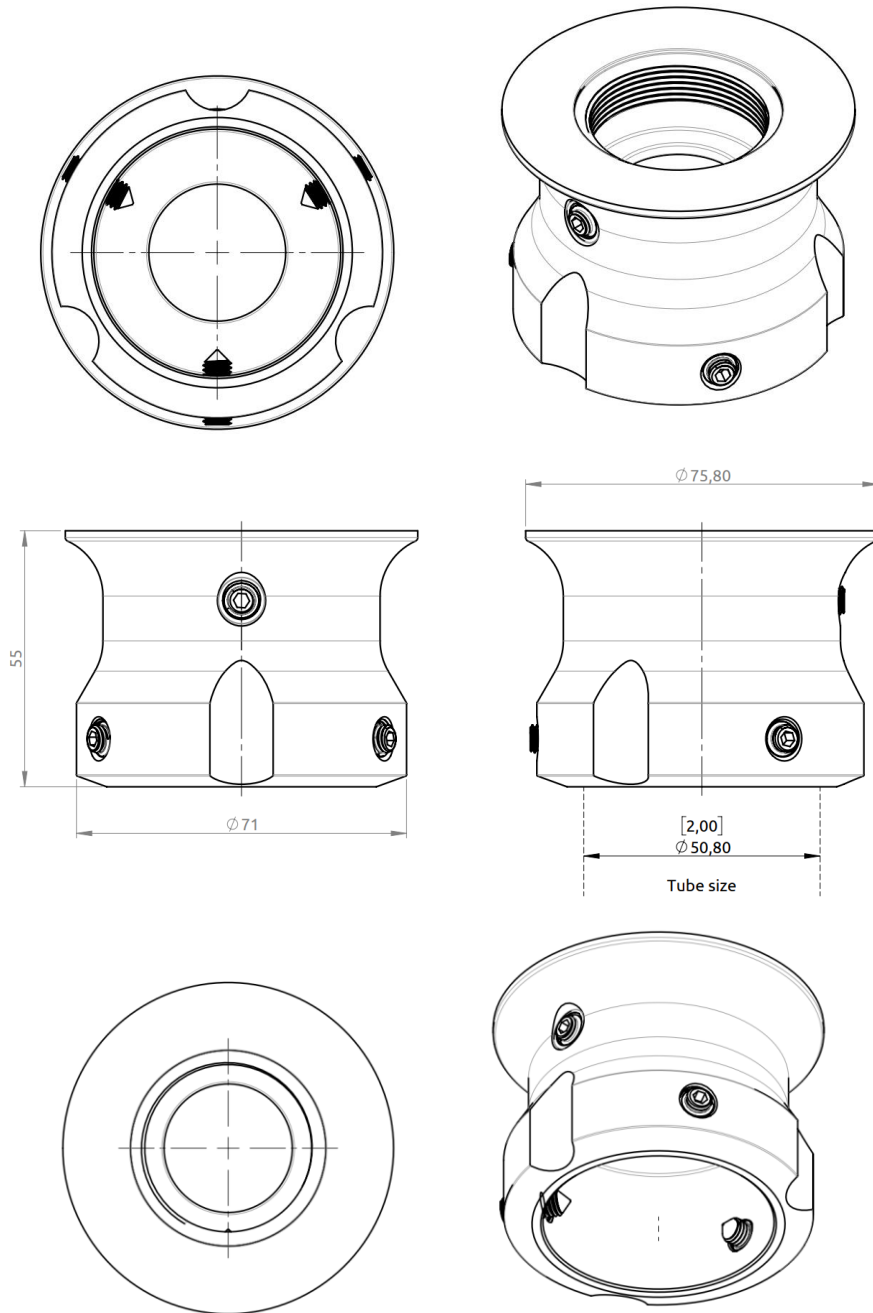

Figure 350: Outline Drawing: Pole Mount (2.0" pipe, Ø53.0 mm), Antenna Unit

App. R - Outline Drawing: Bracket Mount (1.5" to 2.5" pipe), Antenna Unit

NOTE: The Bracket Mount (1.5" to 2.5" pipe), Antenna Unit interfaces to a pipe of maximum 2.5" (63.5 mm), measured outer diameter. The total weight of the Bracket Mount is 0.68 kg (1.50 lbs). Always, use the cable hose as part of the installation.

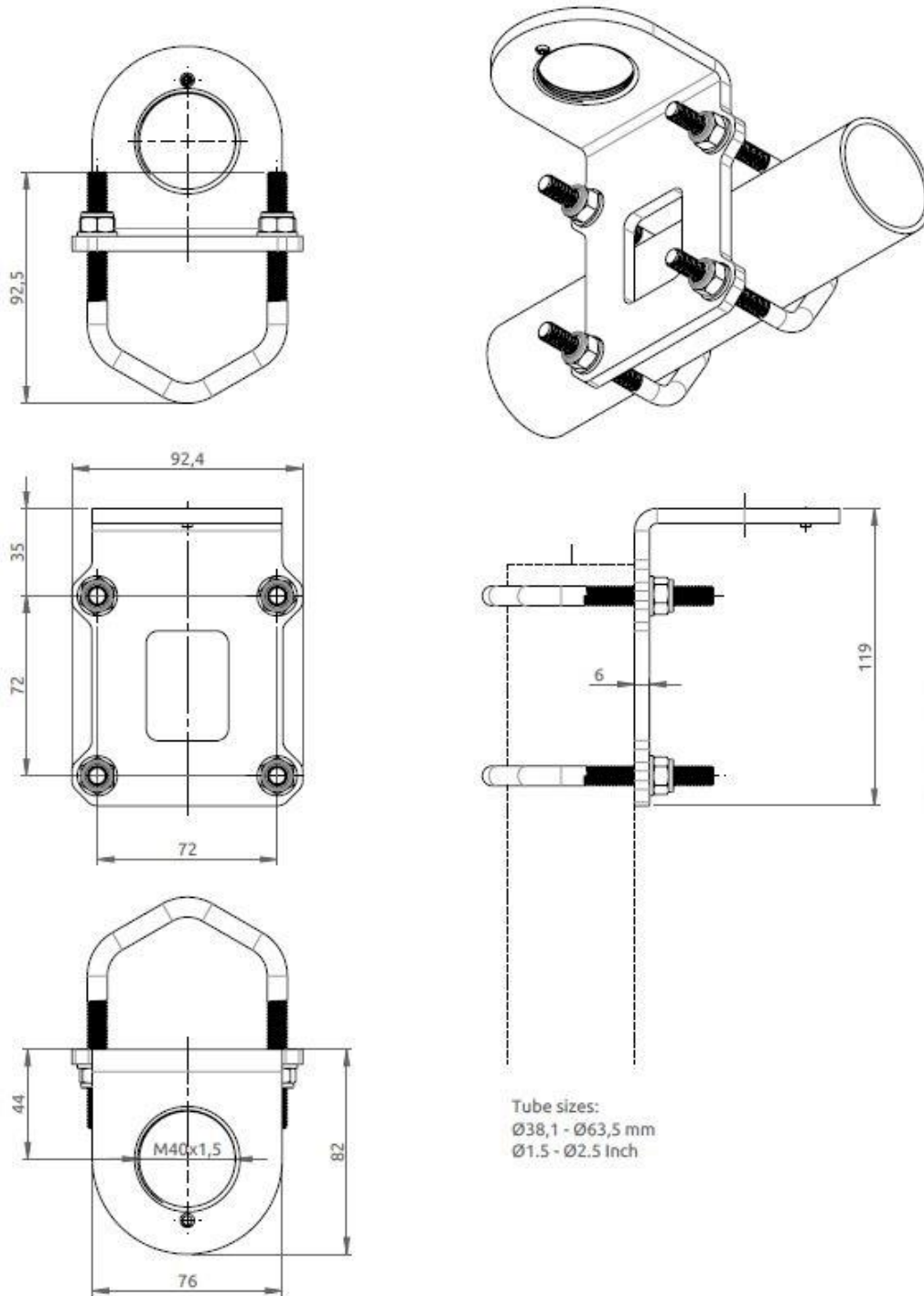

Figure 351: Outline Drawing: Bracket Mount (1.5" to 2.5" pipe), Antenna Unit

App. S - Outline Drawing: LT-3120 Handset

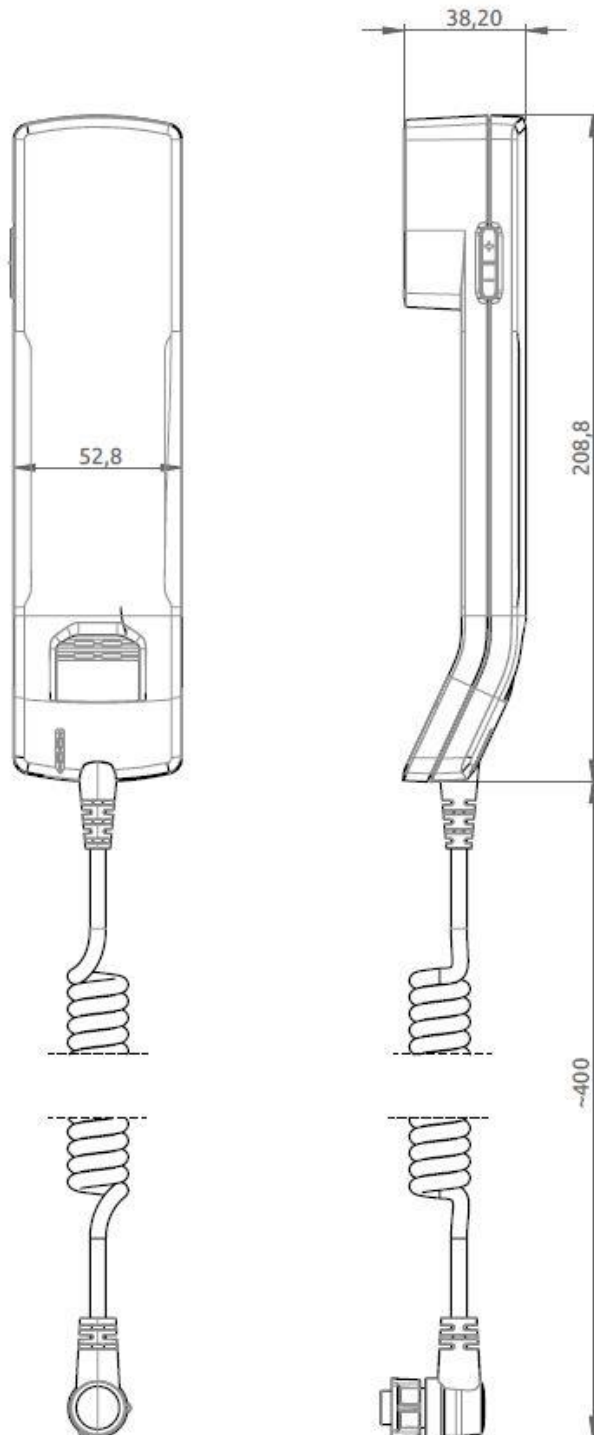

Figure 352: Outline Drawing: LT-3120 Handset

App. T - Outline Drawing: LT-3121 Cradle

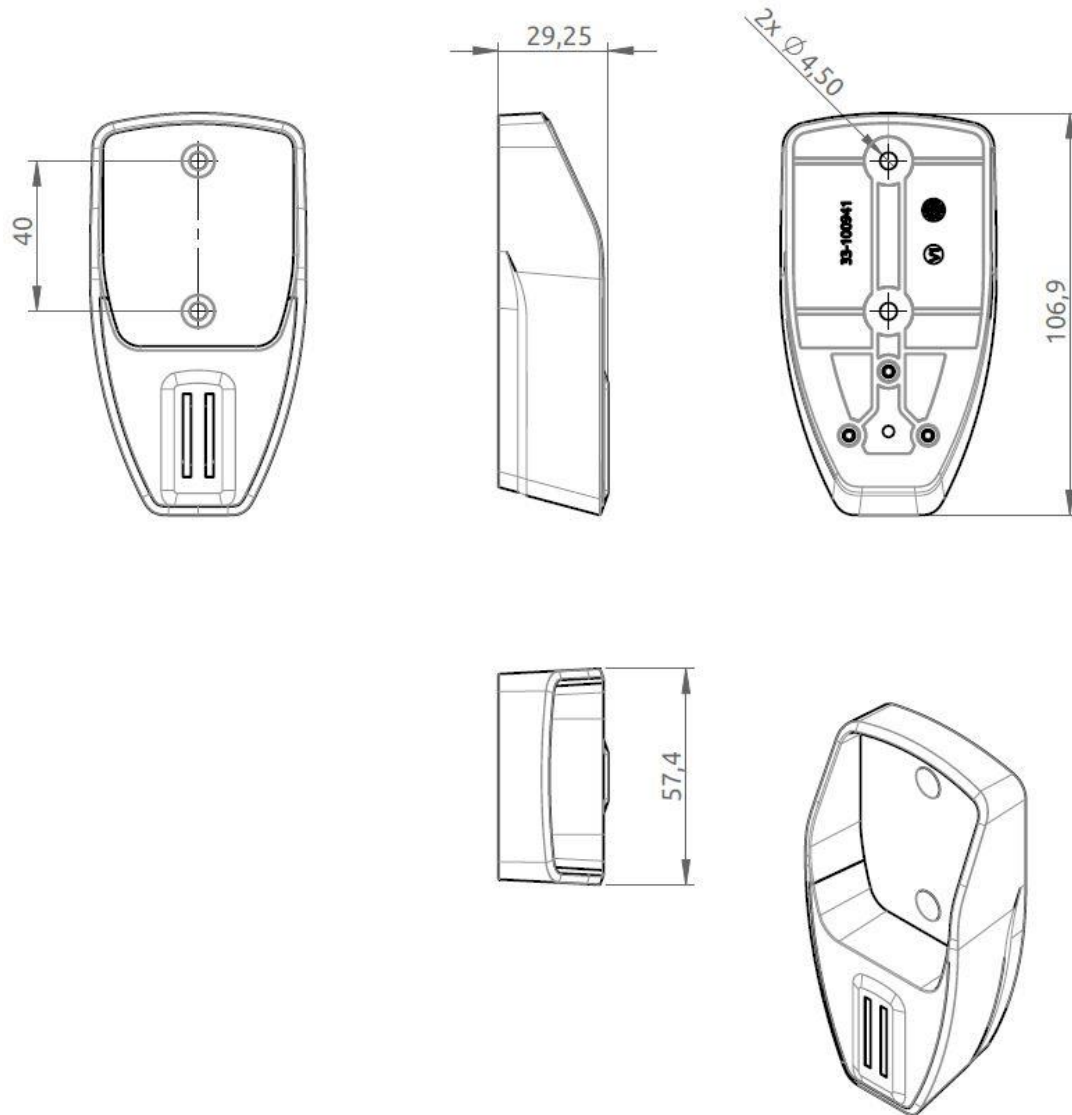

Figure 353: Outline Drawing: LT-3121 Cradle

App. U - Conformity

Radio Equipment Directive (RED) / CE

The LT-3100S GMDSS system is CE certified as stated in the EU Declaration of Conformity (DoC).

The EU DoC for the LT-3100S GMDSS system can be downloaded from the Lars Thrane A/S website, partner area (password required). Please contact Lars Thrane A/S for an electronic copy of the LT-3100S GMDSS system EU DoC.

The LT-3100S GMDSS system complies with the specifications of:

RED directive 2014/53/EU concerning Radio Equipment

Wheelmark (MED)

The LT-3100S GMDSS system is Wheelmark certified as started in the MED Declaration of Conformity (DoC).

The MED DoC for the LT-3100S GMDSS system can be downloaded from the Lars Thrane A/S website, partner area (password required). Please contact Lars Thrane A/S for an electronic copy of the LT-3100S GMDSS system MED DoC. A printed hard copy of the MED DoC for the LT-3100S GMDSS system is delivered with the LT-3100S GMDSS system (incl. printed copies of MED Module B and D).

The LT-3100S GMDSS system complies with the specifications of:

MED directive 2014/90/EU concerning Marine Equipment
Module B (EC Type Examination) and Module D (Approval og Quality System)

Iridium GMDSS

The LT-3100S GMDSS system has obtained an Iridium GMDSS type approval.

All over the world,
close to the customer

JRC/Alpatron Marine B.V.

Schaardijk 23 (harbor 115)
3063 NH Rotterdam
The Netherlands

T +31 10 453 4000
F +31 10 453 4010
service@jrc-europe.com
www.jrc-world.com

The information in this document is subject to change without notice and does not represent a commitment on the part of Alpatron Marine B.V.

Document name : Alpatron LT-3100S GMDSS Iridium
Document nr. : 1028_95-102251
Revision : 1.05
© All rights reserved Alpatron Marine B.V.

Centers of Excellence

Houston, Rotterdam, Singapore, Tokyo