

Owner's Manual

EXPLORER NMEA2000 GPS

GX1850GPS GX1850GPS/E (European Version)

EXPLORER NMEA2000

GX1850

EXPLORER GPS

GX1800GPS GX1800GPS/E (European Version)

EXPLORER

GX1800

-
- International ITU-R M.493-13 Class D DSC (Digital Selective Calling) (European Version: Meets ITU-R M.493-14)
 - NMEA 2000 Compatible (GX1850GPS, GX1850GPS/E and GX1850 only)
 - Input and Output of GPS information to NMEA 0183 compatible devices
 - Integrated 66 Channel Internal GPS receiver (GX1850GPS, GX1850GPS/E, GX1800GPS and GX1800GPS/E only)
 - Automatic DSC polling of up to 6 ships GPS positions*
 - Auto DSC channel selection & DSC test call
 - GPS Compass Page*, Enter and Save Waypoints*, Navigate Routes to Locations*
 - Automatic Distress Messaging*, MOB Report & Location*, MOB Location Navigation*
 - Large Viewable Display, Easy to Mount, Submersible IPX8 (5 feet or 1.5 m for 30 minutes)
 - Noise canceling microphone with channel change, 16/S and H/L key buttons
 - SSM-70H Remote-Access RAM4 Microphone Second Station & Intercom
 - ATIS Mode for European Inland Waterways (GX1850GPS/E and GX1800GPS/E only)

*External GPS device required for GX1850 and GX1800.



STANDARD HORIZON

Nothing takes to water like Standard Horizon

TABLE OF CONTENTS

QUICK REFERENCE	2	9.10 SCANNING	31
1 GENERAL INFORMATION	3	9.10.1 Selecting Scan Type	31
2 PACKING LIST	3	9.10.2 Programming Scan Memory	31
3 OPTIONAL ACCESSORIES	3	9.10.3 Memory Scanning (M-SCAN)	32
4 ONLINE WARRANTY REGISTRATION	4	9.10.4 Priority Scanning (P-SCAN)	32
5 Safety Precautions (Be Sure to Read)	4	9.11 PRESET CHANNELS: INSTANT ACCESS	33
6 GETTING STARTED	6	9.11.1 Programming	33
6.1 ABOUT VHF RADIO	6	9.11.2 Operation	33
6.2 SELECTING AN ANTENNA	6	9.11.3 Deletion	34
6.3 COAXIAL CABLE	6	9.12 MOB OPERATION	34
6.4 DISTRESS AND HAILING (CHANNEL 16)	7	9.13 INTERCOM OPERATION	35
6.5 CALLING ANOTHER VESSEL (CHANNEL 16 OR 9)	8	9.13.1 Communication	35
6.6 Accuracy of COG	8	9.13.2 Calling	35
7 CONTROLS AND INDICATORS	9	9.14 DEMO MODE	35
7.1 FRONT PANEL	9	10 GPS OPERATION	37
7.2 MICROPHONE	11	10.1 DISPLAYING POSITION INFORMATION	37
7.3 REAR PANEL	12	10.1.1 GPS Information Numerical Display	37
8 INSTALLATION	13	10.1.2 GPS Information Compass Display	37
8.1 SAFETY / WARNING INFORMATION	13	10.2 CHECKING GPS STATUS	37
8.2 LOCATION	13	11 DIGITAL SELECTIVE CALLING (DSC)	38
8.3 MOUNTING THE RADIO	13	11.1 GENERAL	38
8.3.1 Supplied Mounting Bracket	13	11.2 DISTRESS ALERT	38
8.3.2 Optional MMB-97 Flush Mount Bracket	14	11.2.1 Transmitting a Distress Alert	38
8.4 ELECTRICAL CONNECTIONS	15	11.2.2 Receiving a Distress Alert	41
8.5 CONNECTION OF EXTERNAL DEVICES TO THE RADIO	16	11.3 ALL SHIPS CALL	42
8.5.1 Connecting the NMEA 0183/NMEA 0183-HS to the Radio	16	11.3.1 Transmitting an All Ships Call	42
8.5.2 Accessory Cables	17	11.3.2 Receiving an All Ships Call	43
8.5.3 Connection to External GPS or Chart Plotter	18	11.4 INDIVIDUAL CALL	44
8.5.4 GPS Input - optional SCU-31 External GPS Antenna	18	11.4.1 Setting up the Individual / Position Call Directory	44
8.5.5 Connection to External Speaker	18	11.4.2 Setting up the Individual Call Reply	45
8.5.6 Connecting the SCU-38 External GPS Antenna to the Radio (GX1850GPS, GX1850GPS/E, GX1800GPS and GX1800GPS/E only)	19	11.4.3 Enabling the Individual Call Acknowledgment	46
8.5.7 Optional SSM-70H (RAM4) Microphone	19	11.4.4 Transmitting an Individual Call	46
8.6 INITIAL SETUP REQUIRED WHEN TURNING ON THE POWER FOR THE FIRST TIME	21	11.4.5 Receiving an Individual Call	48
8.6.1 Maritime Mobile Service Identity (MMSI)	21	11.4.6 Setting up the Individual Call Ringer	49
8.7 CONFIRMING GPS SIGNAL (GPS STATUS DISPLAY)	22	11.5 GROUP CALL	50
8.8 GPS CONFIGURATION	23	11.5.1 Setting up a Group Call	50
8.8.1 Setting the GPS Time	23	11.5.2 Transmitting a Group Call	52
8.8.2 Setting the Time Area	24	11.5.3 Receiving a Group Call	54
8.8.3 Setting the Time Format	24	11.5.4 Setting up the Group Call Ringer	54
8.8.4 Setting COG to True or Magnetic	25	11.6 POSITION REQUEST	55
9 BASIC OPERATION	26	11.6.1 Setting up a Position Request Reply	55
9.1 TURNING THE TRANSCEIVER ON AND OFF	26	11.6.2 Transmitting a Position Request to Another Vessel	56
9.2 RECEPTION	26	11.6.3 Receiving a Position Request	57
9.3 TRANSMISSION	26	11.6.4 Manual Input of Position Information	58
9.3.1 Transmit Power	27	11.6.5 Setting up a Position Request Ringer	58
9.4 BASIC OPERATION OF THE SETUP MENU	27	11.7 POSITION REPORT	59
9.5 TRANSMIT TIME-OUT TIMER (TOT)	28	11.7.1 Transmitting a DSC Position Report Call	59
9.6 SIMPLEX/DUPLEX CHANNEL USE	28	11.7.2 Receiving a DSC Position Report Call	60
9.7 CHANNEL GROUP	28	11.7.3 Navigating to the Reported Position	60
9.8 NOAA WEATHER CHANNELS (in USA and Canada only)	29	11.7.4 Saving the Reported Position as a Waypoint	61
9.8.1 NOAA Weather Alert (USA version only)	29	11.7.5 Setting up a Position Report Ringer	62
9.8.2 NOAA Weather Alert Testing	30	11.8 AUTO POSITION POLLING	62
9.9 MULTI WATCH (TO PRIORITY CHANNEL)	30	11.8.1 Setting up the Polling Operation	62
9.9.1 Setup the Multi Watch Operation	30	11.8.2 Setting up the Polling Time Interval	62
9.9.2 Starting Dual Watch	30	11.8.3 Selecting Vessels to be Automatically Polled	63
		11.8.4 Enabling/Disabling Auto POS Polling	63
		11.9 DSC TEST	64
		11.9.1 Programming MMSI into Individual Directory	64
		11.9.2 Transmitting a DSC Test to Another Vessel	64
		11.9.3 Receiving a DSC Test Call	65
		11.10 DSC LOG OPERATION	65

TABLE OF CONTENTS

11.10.1	Reviewing and Resending a Transmitted Logged Call	66	17.3	INDIVIDUAL ACKNOWLEDGMENT	90
11.10.2	Reviewing a Logged DSC RX Distress Alert and acknowledgement	66	17.4	INDIVIDUAL RINGER	90
11.10.3	Reviewing Other Logged Calls	66	17.5	GROUP DIRECTORY	90
11.10.4	Deleting Logged Calls from the DSC Log Directory	67	17.6	POSITION REPLY	91
11.11	DSC LOOP BACK OPERATION	67	17.7	AUTO POSITION POLLING	91
12	NAVIGATION	68	17.8	AUTO POSITION INTERVAL	91
12.1	WAYPOINT OPERATION	68	17.9	AUTO CHANNEL CHANGE	91
12.1.1	Starting and Stopping Navigation	68	17.10	NO ACTION TIMER	92
12.1.2	Setting Up Waypoint Directory	69	17.11	WAIT TIME FOR POSITION FIX	92
12.1.3	Selecting the Display Range	71	17.12	DSC BEEP	92
12.1.4	Selecting the Arrival Range	71	17.13	WARNING ALARM	92
12.2	ROUTING OPERATION	72	17.14	SUMMARY OF THE DSC SETUP MENU	93
12.2.1	Setting Up Routing Directory	72	18	GPS SETUP	94
12.2.2	Starting and Stopping Route Navigation	74	18.1	ORDER OF PRIORITY (GX1850 series only)	94
12.2.3	Changing the Destination	74	18.2	COMPASS DIRECTION	94
12.2.4	Selecting Automatic or Manual Routing	74	18.3	LOCATION FORMAT	94
13	GM OPERATION	75	18.4	TIME OFFSET	95
13.1	SETTING UP GM OPERATION	75	18.5	TIME AREA	95
13.1.1	Setting Up GM Group Directory	75	18.6	TIME FORMAT	95
13.1.2	Setting Up the Polling Time Interval	76	18.7	UNITS OF MEASURE	95
13.1.3	Enabling/Disabling Transmission during GM Operation	76	18.8	MAGNETIC VARIATION	95
13.2	STARTING GM OPERATION	77	18.9	NMEA 0183 IN/OUT	95
13.2.1	Changing the GM Group Being Monitored	77	18.9.1	Data Speed	95
13.2.2	Transmitting a DSC Call to a Group Member	77	18.9.2	Output Sentences	96
13.2.3	Starting Navigation to a Group Member	78	18.10	Position Data Output	97
14	NMEA 2000 SETUP (GX1850 series only)	79	18.11	INTERNAL GPS UNIT	97
14.1	SELECT DEVICE	79	18.11.1	Unit Power	97
14.2	DEVICE NUMBER	79	18.11.2	Pinning	98
14.3	SYSTEM NUMBER	80	18.11.3	Differential GPS	98
14.4	SUMMARY OF THE NMEA 2000 SETUP	80	18.12	SUMMARY OF THE GPS SETUP	99
14.5	COMPATIBLE NMEA 2000 PGN LIST	80	19	ATIS SETUP (GX1850GPS/E and GX1800GPS/E only)	100
15	CONFIGURATION SETUP	81	19.1	ATIS CODE PROGRAMMING	100
15.1	DISPLAY MODE	81	19.2	ATIS CH GROUP	101
15.2	DIMMER ADJUSTMENT	81	20	SSM-70H (RAM4) REMOTE MIC OPERATION	102
15.3	DISPLAY CONTRAST	81	20.1	REMOTE MIC CONTROLS	102
15.4	KEY BEEP	82	20.2	RAM4 SOFT KEY ASSIGNMENT	105
15.5	SOFT KEYS	82	20.2.1	Key Assignment	106
15.5.1	Key Assignment	82	21	MAINTENANCE	107
15.5.2	Key Timer	83	21.1	REPLACEMENT PARTS	107
15.6	RESET	84	21.2	FACTORY SERVICE	107
15.6.1	Reset the USER MMSI and ATIS CODE	84	21.3	TROUBLESHOOTING CHART	108
15.7	SUMMARY OF THE CONFIGURATION SETUP	86	22	CHANNEL ASSIGNMENTS	109
16	CHANNEL FUNCTION SETUP	87	22.1	GX1850GPS, GX1850, GX1800GPS and GX1800	109
16.1	CHANNEL GROUP	87	22.2	GX1850GPS/E and GX1800GPS/E	112
16.2	WEATHER ALERT (USA version only)	87	23	SPECIFICATIONS	114
16.3	SCAN MEMORY	87	23.1	DIMENSIONS	116
16.4	SCAN TYPE	87	24	FCC RADIO LICENSE INFORMATION	117
16.5	SCAN RESUME	87	24.1	STATION LICENSE	117
16.6	MULTI WATCH	87	24.2	RADIO CALL SIGN	117
16.7	PRIORITY CHANNEL	88	24.3	CANADIAN SHIP STATION LICENSING	117
16.8	SUB CHANNEL	88	24.4	FCC / IC INFORMATION	117
16.9	CHANNEL NAME	88	25	FCC NOTICE	118
16.10	RX LED DIMMER ADJUSTMENT	89	STANDARD HORIZON Limited Warranty	120	
16.11	SUMMARY OF THE CHANNEL FUNCTION SETUP	89	TEMPLATE for the GX1850/GX1800 series	121	
17	DSC SETUP	90			
17.1	INDIVIDUAL DIRECTORY	90			
17.2	INDIVIDUAL REPLY	90			

QUICK REFERENCE

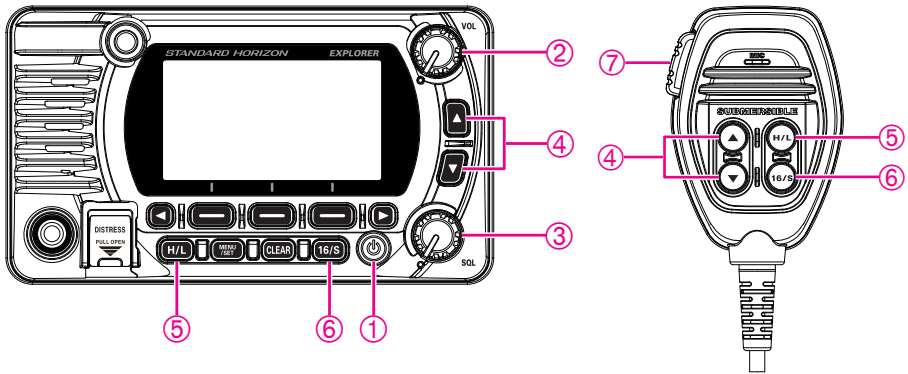

- ① Press and hold the **⏻** key to turn the radio ON or OFF.
- ② Rotate the **VOL** knob to adjust the speaker audio volume.
- ③ Rotate the **SQL** knob clockwise to squelch or counterclockwise to un-squelch the radio.
- ④ Press the **▲/▼** keys (or press the microphone **▲/▼** keys) to select the operating channel.
- ⑤ Press the **H/L** key to toggle the transmit power between High (25W) and Low (1W).
- ⑥ Press the **16/S** key on the radio or the microphone to select channel 16. Press and hold the **16/S** key on the radio or the microphone to select sub channel. Press the **16/S** key again to revert to the previously selected channel.
- ⑦ To transmit: place the microphone about 2 cm away from your mouth and speak in a normal voice level while pressing the **PTT** switch.

1 GENERAL INFORMATION

The STANDARD HORIZON **GX1850/GX1800** Marine VHF/FM Marine transceiver is designed to be used in International, USA, Canadian and other Region Marine channels. The **GX1850/GX1800** series can be operated from 11 to 16 VDC and has a switchable RF output power of 1 watt or 25 watts.

The **GX1850/GX1800** series is capable of DSC (Digital Selective Calling) ITU-R M.493 Class D operation with a 66-channel internal GPS (GX1850GPS, GX1850GPS/E, GX1800GPS and GX1800GPS/E only). Class D operation allows continuous reception of Digital Selective Calling functions on channel 70 even while receiving calls on the voice channels. The **GX1850/GX1800** series operates on all currently-allocated marine channels and is switchable for use with International, USA, or Canadian regulations. Emergency channel 16 can be immediately selected from any other channel by pressing the [**16/S**] key.

Other features of the **GX1850/GX1800** series include: NMEA 2000 compatibility (GX1850GPS, GX1850GPS/E and GX1850 only) and high expandability. It is capable of being connected to the optional wired **SSM-70H (RAM4)** microphone, which provides full remote control of all VHF and DSC functions. It also includes an intercom feature providing communication between the radio and the RAM4 microphone, scanning functions, priority scanning, dual watch, DSC position polling up to 6 vessels, high and low voltage warning, and repeatability of received GPS location information.

2 PACKING LIST

Open the package and verify it contains the following items:

- Transceiver
- DC Power Cord
- Mounting Bracket and Hardware
- Owner's Manual
- DSC Warning Sticker (GX1850GPS, GX1850, GX1800GPS and GX1800 Only)

3 OPTIONAL ACCESSORIES

- Dust Cover (white) **HC1600**
- Flush-Mount Bracket **MMB-97**
- Remote-Access Microphone (RAM4 Microphone)*1 **SSM-70H**
*1(The SSM-70H firmware must be Ver. 2.00.00 or later.)
- External GPS Antenna with 16 ft (5 m) of Cable (for GX1850GPS, GX1850GPS/E, GX1800GPS and GX1800GPS/E only) **SCU-38**
- External GPS Antenna with 49 ft (15 m) of Cable*2 **SCU-31**
*2(Built-in GPS Receiver. Refer to section 8.5.4 for connections.)
- 23 ft (7 m) Extension Cable for SSM-70H (RAM4 Microphone) ... **CT-100**
- External Loud Speaker **MLS-300**

4 ONLINE WARRANTY REGISTRATION

Please visit www.standardhorizon.com - Owner's Corner to register the **GX1850/GX1800** Marine VHF Transceiver.

NOTE: Visiting the STANDARD HORIZON website from time to time may be beneficial. When new products are released, information will appear on the website.

5 Safety Precautions (Be Sure to Read)

Be sure to read these important precautions, and use this product safely.

Yaesu is not liable for any failures or problems caused by the use or misuse of this product by the purchaser or any third party. Also, Yaesu is not liable for damages caused through the use of this product by the purchaser or any third party, except in cases where ordered to pay damages under the laws.

Types and meanings of the marks



DANGER

This mark indicates an imminently hazardous situation, which, if not avoided, could result in death or serious injury.



WARNING

This mark indicates a potentially hazardous situation, which, if not avoided, could result in death or serious injury.



CAUTION

This mark indicates a potentially hazardous situation, which, if not avoided, may result in minor or moderate injury or only property damage.

Types and meanings of symbols



These symbols signify prohibited actions, which must not be done to use this product safely. For example:  indicates that the product should not be disassembled.



These symbols signify required actions, which must be done to use this product safely. For example:  indicates the power plug should be disconnected.



DANGER



Do not operate the device when flammable gas is generated.
Doing so may result in fire and explosion.



If thunder and lightning develop nearby when an external antenna is used, immediately turn this transceiver OFF, and disconnect the external antenna from it.
A fire, electrical shock, or damage may result.



Do not transmit with this device while carrying or using a medical appliance such as a cardiac pacemaker. When transmitting, use an external antenna and keep as far as possible away from the external antenna.
The radio wave emitted by the transmitter can cause the medical device to malfunction and result in injury or death.



Do not touch any liquid leaking from the liquid display with your bare hands.
There is a risk of chemical burns occurring when the liquid comes into contact with the skin or gets into the eyes. In this case, seek medical treatment immediately.



WARNING



Do not power this transceiver with a voltage other than the specified power supply voltage.
A fire, electric shock, or damage may result.



Do not make very long transmissions.
The main body of the transceiver may overheat, resulting component failure or operator burns.



Do not disassemble or make any alteration to this product.
An injury, electric shock, or failure may result.



Never touch the antenna during transmission.
This may result in injury, electric shock and equipment failure.



Do not handle the power plug and connector etc. with wet hands. Also do not plug and unplug the power plug with wet hands.
This may result in injury, liquid leak, electric shock and equipment failure.



Disconnect the power cord and connection cables before incorporating items sold separately or replacing the fuse.
This may result in fire, electric shock and equipment failure.



When smoke or strange odors are emitted from the radio, turn off the power and disconnect the power cord from the socket.

This may result in fire, liquid leak, overheating, damage, ignition and equipment failure. Please contact our company customer support or the retail store where you purchased the device.



Keep the power plug pins and the surrounding areas clean at all time.

This may result in fire, liquid leak, overheating, breakage, ignition etc.



Never cut the fuse holder off of the DC power cord.

This may cause a short circuit and result in ignition and fire.



Use only the specified type fuses.

Use of an incorrect fuse may result in fire and equipment failure.



When connecting a DC power cord, be certain the positive and negative polarities are correct.
Reverse connection will result in equipment damage.



Do not use DC power cords other than the one enclosed or specified.

This may result in fire, electric shock and equipment malfunctions.



Do not bend, twist, pull, heat and modify the power cord and connection cables in an unreasonable manner.

This may cut or damage the cables and result in fire, electric shock and equipment failure.



Do not pull the cable when plugging and unplugging the power cord and connection cables.

Always hold the plug or connector when unplugging; if not, a fire, electric shock and equipment failure may result.



Do not use the device when the power cord and connection cables are damaged, or when the DC power connector cannot be plugged in tightly.

Contact Yaesu Amateur Customer Support or the retail store where this transceiver was purchased for assistance, as this may result in fire, electric shock and equipment failure.



Follow the instructions provided when installing items sold separately and replacing the fuse.

This may result in fire, electric shock and equipment failure.



Use only the provided or specified screws.

Using screws of a different size, may result in fire, electric shock and component damage.



CAUTION



Do not place the transceiver on an unsteady or sloping surface, or in a location with extreme vibration.

The transceiver may fall or drop, resulting in fire, injury and equipment damage.



Stay as far away from the antenna as possible during transmission.

Long-term exposure to electromagnetic radiation may have a negative effect on the human body.



Do not wipe the case using thinner and benzene etc.

Use only a soft, dry cloth to wipe stains from the case.



Keep this product out of the reach of children.
Injury to the child, or damage to the transceiver may result.



Do not put heavy objects on top of the power cord and connection cables.

This may damage the power cord and connection cables, resulting in fire and electric shock.



Do not use any products other than the specified options and accessories.

Failure or miss operation may result.



For safety reasons, switch off the power and pull out the DC power cord connected to the DC power connector when the device is not going to be used for a long period of time.

If not, this may result in fire and overheating.



Do not throw the transceiver, or subject it to strong impact forces.

Physical abuse may result in component damage and equipment failure.



Keep magnetic cards and videotapes away from the transceiver.

The data recorded on cash cards or videotapes may be erased.



Do not stand on top of the product, and do not place heavy objects on top or insert objects inside it.

If not, this may result in equipment failure.

6 GETTING STARTED

6.1 ABOUT VHF RADIO

The radio frequencies used in the VHF marine band lie between 156 and 158 MHz with some shore stations available between 161 and 163 MHz. The marine VHF band provides communications over distances that are essentially “line of sight” (VHF signals do not travel well through objects such as buildings, hills or trees). Actual transmission range depends much more on antenna type, gain and height than on the power output of the transmitter. On a fixed mount 25 W radio transmission expected distances can be greater than 25 km, for a portable 5 W radio transmission the expected distance can be greater than 8 km in “line of sight”.

6.2 SELECTING AN ANTENNA

Marine antennas are made to radiate signals equally in all horizontal directions, but not straight up. The objective of a marine antenna is to enhance the signal toward the horizon. The degree to which this is accomplished is called the antenna gain. It is measured in decibels (dB) and is one of the major factors in choosing an antenna. In terms of effective radiated power (ERP), antennas are rated on the basis of how much gain they have over a theoretical antenna with zero gain. A 1 m, 3 dB gain antenna represents twice as much gain over the imaginary antenna.

Typically, a 1 m 3 dB gain stainless steel whip is used on a sailboat mast. The longer 2.5 m 6 dB fiberglass whip is primarily used on power boats that require the additional gain.

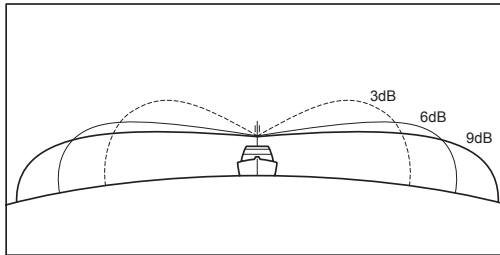

6.3 COAXIAL CABLE

VHF antennas are connected to the transceiver by means of a coaxial cable – a shielded transmission line. Coaxial cable is specified by its diameter and construction.

For runs less than 20 feet (6 m), RG-58/U (about 0.25" (6 mm) in diameter), is a good choice. For runs over 20 feet (6 m) but less than 50 feet (15 m), the larger RG-8X or RG-213/U should be used. For cable runs over 50 feet (15 m) RG-8X should be used. For installation of the connector onto the coaxial cable refer to the figure.

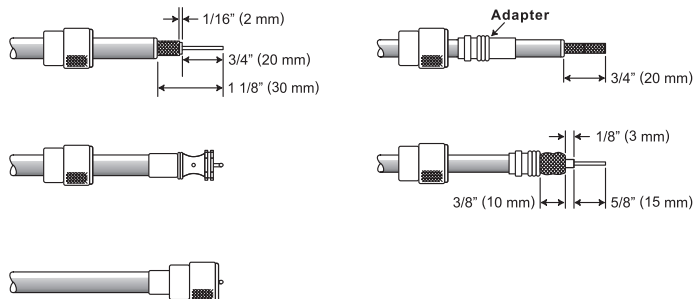

To get the coax cable through a fitting and into the boat's interior, you may have to cut the end plug off and reattach it later. Follow the directions that come with the connector to attach it. Be sure to make good soldered connections.

6.4 DISTRESS AND HAILING (CHANNEL 16)

Channel 16 is known as the Hail and Distress Channel. An emergency may be defined as a threat to life or property. In such instances, be sure the transceiver is ON and set to CHANNEL 16. Then use the following procedure:

1. Press the microphone push-to-talk switch and say "**Mayday, Mayday, Mayday**. This is _____, _____, _____" (your vessel's name).
2. Then repeat once: "**Mayday**, _____" (your vessel's name).
3. Now report your position in latitude/longitude, or by giving a true or magnetic bearing (state which) to a well-known landmark such as a navigation aid or geographic feature such as an island or harbor entry.
4. Explain the nature of your distress (sinking, collision, aground, fire, heart attack, life-threatening injury, etc.).
5. State the kind of assistance your desire (pumps, medical aid, etc.).
6. Report the number of persons aboard and condition of any injured.
7. Estimate the present seaworthiness and condition of your vessel.
8. Give your vessel's description: length, design (power or sail), color and other distinguishing marks. The total transmission should not exceed 1 minute.
9. End the message by saying "**OVER**". Release the microphone switch and listen.
10. If there is no answer, repeat the above procedure. If there is still no response, try another channel.

NOTE

The transceiver has the DSC Distress calling, that can transmit a distress call digitally to all ships with compatible DSC radios. Refer to section "**11 DIGITAL SELECTIVE CALLING (DSC)**".

6.5 CALLING ANOTHER VESSEL (CHANNEL 16 OR 9)

Channel 16 may be used for initial contact (hailing) with another vessel. However, its most important use is for emergency messages. This channel must be monitored at all times, except when actually using another channel.

It is monitored by the U.S. and Canadian Coast Guards and by other vessels.

Use of channel 16 for hailing must be limited to initial contact only. Calling should not exceed 30 seconds, but may be repeated 3 times at 2-minute intervals. In areas of heavy radio traffic, congestion on channel 16 resulting from its use as a hailing channel can be reduced significantly in U.S. waters by using **channel 9** as the initial contact (hailing) channel for non-emergency communications. Here, also, calling time should not exceed 30 seconds but may be repeated 3 times at 2-minute intervals.

Prior to contacting with another vessel, refer to the channel charts in this manual, and select an appropriate channel for communications after initial contact. For example, Channels 68 and 69 of the U.S. VHF Charts are some of the channels available to non-commercial (recreational) boaters. Monitor the desired channel in advance to make sure you will not be interrupting other traffic, and then go back to either channel 16 or 9 to make initial contact.

When the hailing channel (16 or 9) is clear, press the **PTT** switch on the mic and state the name of the other vessel you wish to call and then “this is” followed by the name of your vessel and your Station License (Call Sign) then release the **PTT** switch on the mic. When the other vessel returns your call, immediately request another channel by pressing the **PTT** switch on the mic and saying “**go to**,” the number of the other channel, say “**over**” and release the **PTT** switch on the mic. Then switch to the new channel. When the new channel is not busy, call the other vessel.

After a transmission, say “**over**,” and release the microphone’s push-to-talk (**PTT**) switch. When all communication with the other vessel is completed, end the last transmission by stating your Call Sign and the word “**out**.” Note that it is not necessary to state your Call Sign with each transmission, only at the beginning and end of the contact.

Remember to return to Channel 16 when not using another channel. Some radios automatically monitor Channel 16 even when set to other channels or when scanning.

6.6 Accuracy of COG

The error in the COG (the path of the antenna position over ground) due to the actual ship’s speed over ground shall not exceed the following values:

Speed range (knots)	Accuracy of COG output to user
0 to ≤1 knot	Unreliable or not available
>1 to ≤17 knots	±3°
>17 knots	±1°

7 CONTROLS AND INDICATORS

This section defines each control of the transceiver. See illustration below for location of controls. For detailed operating instructions refer to chapter 9 of this manual.

7.1 FRONT PANEL

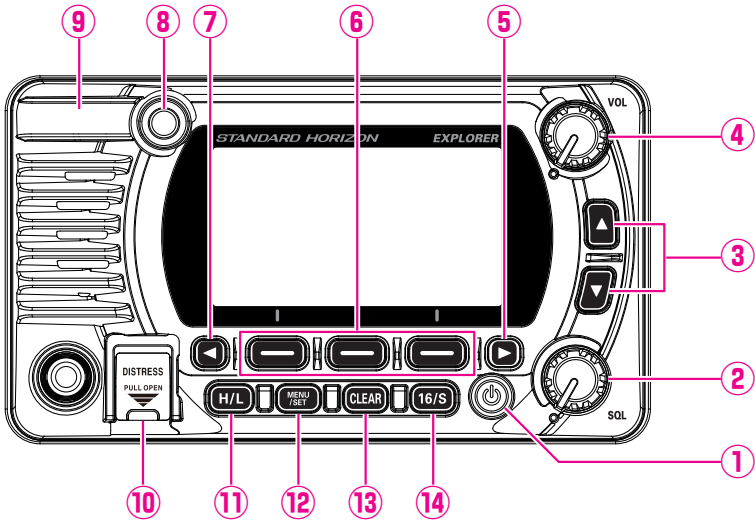

① (Power) key

Press and hold to toggle the radio **ON** or **OFF**. When the power is turned **ON**, the transceiver is set to the last selected channel.

② **SQL knob** (Squelch control)

Adjusting this control clockwise, sets the point at which random noise on the channel does not activate the audio circuits but a received signal will be heard. This point is called the squelch threshold. Further adjustment of the squelch control will degrade reception of wanted transmissions.

③ **▲&▼ key**

These keys are used to change the operating channel. The Up/Down keys on the microphone can also be used to change the operating channel. Press the key momentarily to increase or decrease the channel one step. Holding the key increases or decreases the channels continuously.

SECONDARY USE

- While the MENU screen is displayed, press the key to slide the on-screen menu upward/downward.

- ④ **VOL knob** (Volume control)
Adjusts the audio volume level.
Clockwise rotation of this knob increases the internal and speaker microphone volume.
- ⑤ / ⑦ **◀ & ▶ key**
When the soft keys are displayed, press these keys to switch the function of soft keys.
SECONDARY USE
While the MENU screen is displayed, press the key to slide the on-screen menu to the right/left side.
- ⑥ **Soft keys**
Press these keys to display the soft keys.
The 3 programmable soft keys can be customized by the Setup Menu described in section “**15.5 SOFT KEYS**”.
- ⑧ **BUSY Indicator LED**
This indicator glows green when the squelch opens.
- ⑨ **GPS Antenna** (GX1850GPS, GX1850GPS/E, GX1800GPS and GX1800GPS/E only)
Built in GPS antenna is located here.
- ⑩ **DISTRESS key**
Used to send a DSC Distress Call. To send the distress call, refer to section “**11.2.1 Transmitting a Distress Alert**”.
- ⑪ **H/L key**
Press this key to toggle between 25 W (High) and 1 W (Low) power. When the TX output power is set to “Low” while the transceiver is on channel 13 or 67 (USA Channel group only), the output power will temporarily switch from “Low” to “High” power until the **PTT** switch of the microphone is released. This key is not available on transmit inhibited and low power only channels.
- ⑫ **MENU/SET key**
Press to access MENU.
Press and hold to access SETUP MENU. For details, refer to section “**9.4 BASIC OPERATION OF THE SETUP MENU**”.
- ⑬ **CLEAR key**
Press this key to cancel a menu selection.
- ⑭ **16/S key**
Pressing this key immediately recalls channel 16 from any channel location. Holding down this key selects the SUB channel (The default SUB channel setting is channel 9). Pressing this key again reverts to the previous selected working channel.

7.2 MICROPHONE

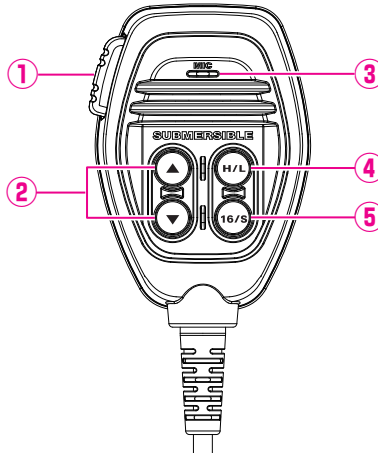

① **PTT (Push-To-Talk) switch**

When in radio mode and the **PTT** switch is pressed, the transmitter is enabled for voice communications to another vessel.

When an optional **SSM-70H** Microphone RAM4 is connected and intercom mode is selected, pressing the **PTT** switch enables voice communications from the transceiver to the **SSM-70H** second station microphone **RAM4**.

② **▲ & ▼ key**

These keys on the microphone are used to select channels and to choose menu items.

③ **Microphone**

The internal microphone transmits your voice and reduces background noise using Clear Voice Noise Reduction Technology.

When transmitting, position the microphone about 2 cm away from your mouth. Speak slowly and clearly into the microphone.

④ **H/L key**

Press this key to toggle between 25 W (High) and 1 W (Low) power. When the TX output power is set to “Low” and the transceiver is on channel 13 or 67 (USA Channel group only), the output power will temporarily switch from “Low” to “High” power until the **PTT** switch of the microphone is released. High power TX is not available on transmit inhibited and low power only channels.

⑤ **16/S key**

Pressing this key immediately selects channel 16 from any channel location. Holding down this key selects the Sub channel (The default SUB channel setting is channel 9). Pressing this key again reverts to the previous selected working channel.

7.3 REAR PANEL

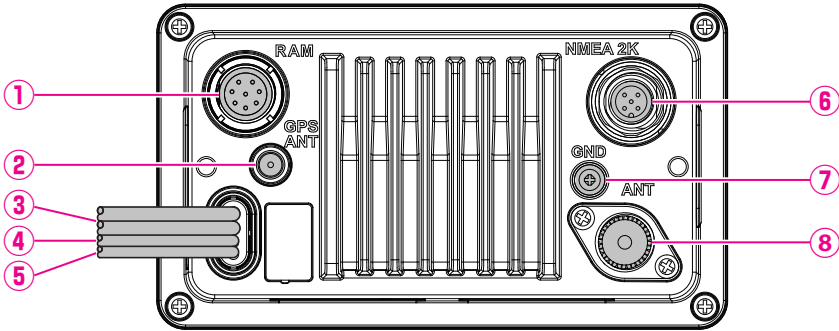

- ① **RAM Remote Access Microphone Connector**
Connects the **SSM-70H (RAM4)** Remote Station Microphone. Refer to section “**20 SSM-70H (RAM4) REMOTE MIC OPERATION**” for details.
NOTE: It is not allowed to connect the **SCU-30** Wireless Access Point to this connector.
- ② **GPS ANT Connector** (GX1850GPS, GX1850GPS/E, GX1800GPS and GX1800GPS/E only)
Connects the optional **SCU-38** External GPS Antenna.
- ③ **DC Input Cable**
Connects the transceiver to a DC power supply capable of delivering 11 to 16 VDC.
- ④ **Accessory Connection Cable** (Yellow, Green, Gray and Brown)
Connects the transceiver to a GPS chart plotter. Refer to section “**8.5.2 Accessory Cables**”.
- ⑤ **EXTERNAL Speaker Connection Cable** (White & Shield)
Connects the transceiver to an optional external speaker. Refer to section “**3 OPTIONAL ACCESSORIES**” for the available optional STANDARD HORIZON accessories.
Speaker connections:
White: External Speaker (+)
Shield: External Speaker (-)
- ⑥ **NMEA 2K Connector** (GX1850GPS, GX1850GPS/E and GX1850 only)
Connects to the NMEA 2000 network.
- ⑦ **GND Terminal** (Ground Terminal)
Connects the transceiver to ships ground, for safe and optimum performance. Use the screw supplied with the transceiver only.
- ⑧ **VHF ANT Jack** (VHF antenna jack)
Connects an antenna to the transceiver. Use a marine VHF antenna with an impedance of 50 ohms.

8 INSTALLATION

8.1 SAFETY / WARNING INFORMATION

Operation of this radio is restricted to occupational use, work related operations only where the radio operator must have the knowledge to control the exposure conditions of passengers and bystanders by maintaining the minimum separation distance of 3 feet (1 m). Failure to observe these restrictions will result in exceeding the FCC RF exposure limits.

Antenna Installation:

The antenna must be located at least 3 feet (1 m) away from passengers in order to comply with the FCC RF exposure requirements.

8.2 LOCATION

The radio can be mounted at any angle. Choose a mounting location that:

- complies with the compass safe distances shown in the table below to prevent interference to a magnetic compass

Transceiver Unit	1.0 m
Handset	0.5 m

- provides accessibility to the front panel controls
- allows connection to a power source and antennas
- has nearby space for installation of a microphone hanger
- is at least 3 feet (1 m) away from the radio's antenna
- the signals from the GPS satellites can be adequately received

NOTE: To insure the radio does not affect the compass or radio's performance is not affected by the antenna location, temporarily connect the radio in the desired location and:

- a. Examine the compass to see if the radio causes any deviation
- b. Connect the antenna and key the radio. Check to ensure the radio is operating correctly by requesting a radio check.

8.3 MOUNTING THE RADIO

8.3.1 Supplied Mounting Bracket

The supplied mounting bracket allows desktop mounting.

Use a 13/64" (5.2 mm) bit to drill the holes to a surface which is more 0.4 inch (10 mm) thick and can support more than 3.3 lbs (1.5 kg) and secure the bracket with the supplied screws, spring washers, flat washers, and nuts.

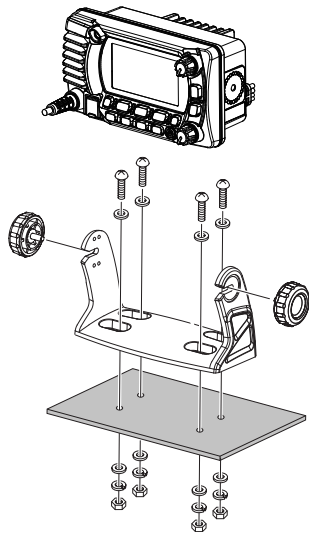

Desktop Mounting

8.3.2 Optional MMB-97 Flush Mount Bracket

A GPS receiver and antenna are located in the front panel of the **GX1850GPS**, **GX1850GPS/E**, **GX1800GPS** and **GX1800GPS/E**. In many cases the radio may be flush mounted, however before cutting holes to flush mount the radio it is recommended to temporarily connect the radio to power and turn it ON in the location where it will be flush mounted to confirm on the display that it is able to receive a GPS location. If the radio is not able to receive a location, a connection to a GPS Chart plotter with NMEA 0183 output, or the optional **SCU-38** External GPS Antenna may be needed to receive GPS satellite signals.

1. Use the template (page 121) to mark the location where the rectangular hole is to be cut. Confirm the space behind the dash or panel is deep enough to accommodate the transceiver (at least 3.74 inches (95 mm) deep). There should be at least 1/2 inch (1.3 cm) between the transceiver's heat-sink and any wiring, cables or structures.
2. Cut out the rectangular hole and insert the transceiver.
3. Fasten the brackets to the rear panel of the transceiver (see illustration).
4. Turn the adjusting screw to adjust the tension so that the transceiver is tight against the mounting surface.

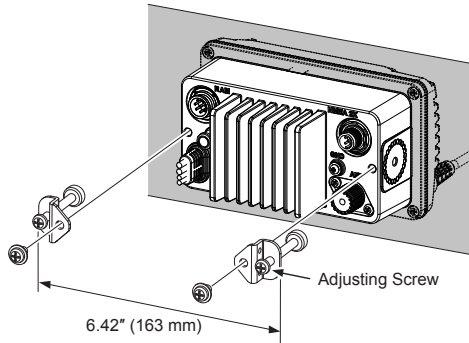

8.4 ELECTRICAL CONNECTIONS

CAUTION

Reverse polarity battery connections will damage the radio!

Connect the power cord and antenna to the radio. Antenna and Power Supply connections are as follows:

1. Mount the antenna at least 3.28 feet (1 m) away from the radio. At the rear of the radio, connect the antenna cable. The antenna cable must have a PL259 connector attached. RG-8/U coaxial cable must be used if the antenna is 25 feet (7.6 m) or more from the radio. RG58 cable can be used for distances less than 25 feet (7.6 m).
2. Connect the red power wire to a 13.8 VDC $\pm 20\%$ power source. Connect the black power wire to a negative ground.
3. If an optional external speaker is to be used, refer to section 8.5 for connections.
4. It is advisable to have a Certified Marine Technician check the power output and the standing wave ratio of the antenna after installation.

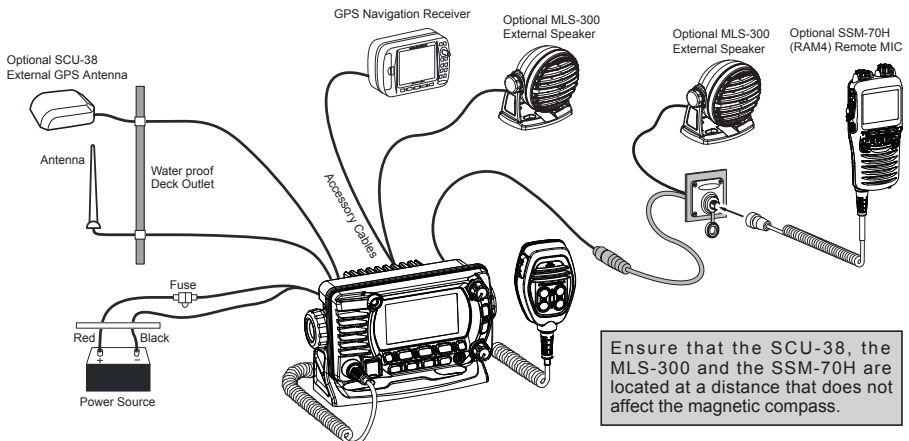

Ferrite Cores

To suppress RF interference that can cause abnormal operation of the transceiver, attach the supplied two ferrite cores as shown below: one to the accessory cable and the DC Power code together, and other to the NMEA Cable and the Speaker Cable together. Then snap the two halves of each ferrite core together. Attach each ferrite core as close as possible to the transceiver body. Finally, wind some plastic tape around each ferrite core, to prevent vibration from causing the two halves to split apart.

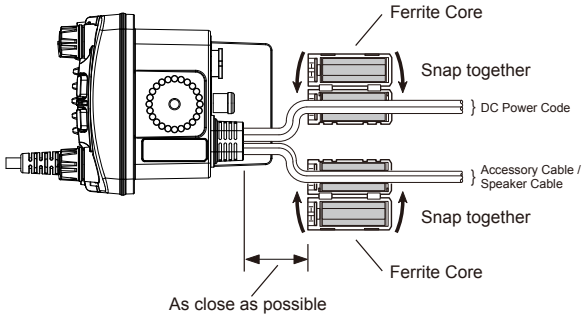

Fuse Replacement

To remove the fuse from the fuse holder, hold both ends of the fuse holder and pull the fuse holder apart without bending the fuse holder. When replacing the fuse, confirm that the fuse is tightly fixed into the metal contact located inside the fuse holder. If the metal contact holding the fuse is loose, the fuse holder may heat up.

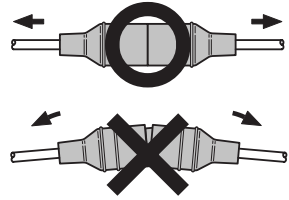

8.5 CONNECTION OF EXTERNAL DEVICES TO THE RADIO

8.5.1 Connecting the NMEA 0183/NMEA 0183-HS to the Radio

External GPS Device Connections (NMEA 0183 4800 baud or NMEA 0183-HS 38400 baud)

The **GX1850/GX1800** series can select the NMEA baud rate between “4800 bps” and “38400 bps”. Refer to section “**18.9 NMEA 0183 IN/OUT**” for selection.

NMEA Input (GPS Information)

- The transceiver can read NMEA 0183 version 2.0 or higher, and NMEA 0183-HS version 1.01 or higher.
- The NMEA 0183 input sentences are GLL, GGA, RMC, GNS, GSA, and GSV (RMC sentence is recommended).

- If 4800 baud (default) is selected:
The Yellow and Green input wires are at 4800 baud.
- If 38400 baud is selected:
The Yellow and Green input wires are at 38400 baud.

NMEA Output (DSC and GPS information)

- The NMEA 0183 output sentences are DSC and DSE.
- If 4800 baud (default) is selected:
The White and Brown wires output DSC and DSE sentences.
- If 38400 baud is selected:
The White and Brown output wires are at 38400 baud and include DSC (DSC, DSE) sentences.
- GSA, GSV, GLL, GGA, and RMC sentences can be output from the transceiver using settings in the GPS setup menu (refer to section “**18.9 NMEA 0183 IN/OUT**”).

For further information on interfacing and setting up GPS operation, contact the manufacturer of the externally connected GPS receiver. If you have further questions, please contact your Dealer.

8.5.2 Accessory Cables

The image and table below show the wires of the transceiver and the connections to optional devices such as an external GPS antenna and a GPS chart plotter.

CAUTION

Care must be taken not to touch any of the NMEA wires to positive 12 VDC or the radio may be damaged.

When connecting the Chart Plotter, External GPS receiver, or External Speaker strip off about 1" (2.5 cm) of the specified wire’s insulation, then splice the ends together.

The transceiver uses NMEA 0183/-HS protocol to share coordinates and DSC information to and from a GPS chart plotter.

Wire Color/Description	Connection Examples
Yellow: NMEA GPS Input (+)	NMEA (+) output of GPS
Green: NMEA GPS Input (-)*1	NMEA (-) output or common ground of GPS
White: NMEA DSC Output (+)	NMEA (+) input of GPS
Brown: NMEA DSC Output (-)*1	NMEA (-) input or common ground of GPS

NOTE: *1Some GPS chart plotters have a single wire for NMEA signal ground. In this case, connect the NMEA input (-) to the GPS chart plotter’s single NMEA signal ground wire, and leave the NMEA output (-) open. In case the assignment of power supply and ground of a GPS chart plotter to be used is different from that of the radio, connect the signal ground wire of the GPS chart plotter to the ground terminal (GND) on the rear panel of the radio.

8.5.3 Connection to External GPS or Chart Plotter

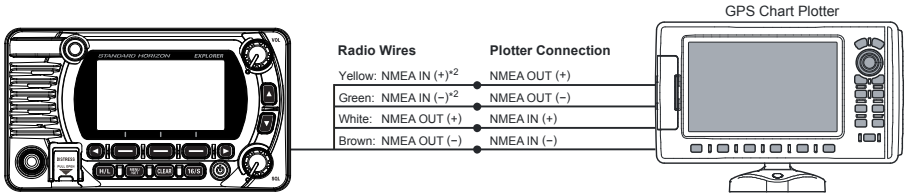

NOTE: *2To input the GPS coordinates from an external GPS device to the transceiver, the NMEA GPS input (+) (yellow) and the NMEA GPS input (-) (green) wires may be connected to the NMEA output of the external GPS antenna or GPS chart plotter.

To connect with an external device at 38400 baud

To connect with an external device at 38400 baud, the transceiver may be setup to receive GPS coordinates and send DSC signals at 38400 baud. Refer to section “18.9 NMEA 0183 IN/OUT” for details.

8.5.4 GPS Input - optional SCU-31 External GPS Antenna

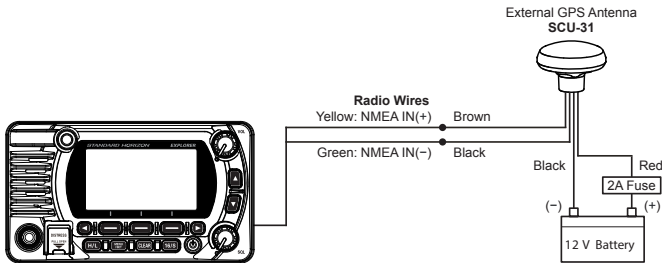

The **SCU-31** External GPS Antenna (Built-in GPS receiver) is supplied with 49 feet (15 m) of cable and a connector. To connect the **SCU-31** to the transceiver, cut off the 6 pin antenna connector, strip the white insulation to expose the Red, Black and Brown wires and connect as shown in the diagram. All other wires are not used and may be cut off. The 2 amp fuse is not included.

8.5.5 Connection to External Speaker

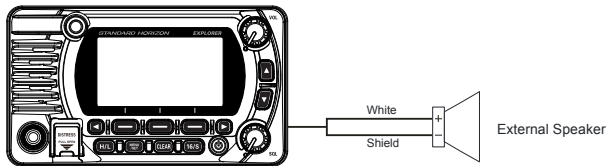

Wire Color/Description	Connection Examples
White: External Speaker (+)	Positive wire of external 4 Ohm External speaker
Shield: External Speaker (-)	Negative wire of external 4 Ohm External speaker

8.5.6 Connecting the SCU-38 External GPS Antenna to the Radio (GX1850GPS, GX1850GPS/E, GX1800GPS and GX1800GPS/E only)

Connect the **SCU-38** cable to the coaxial GPS ANT connector on the rear panel, then tighten the cable nut (see illustration at the right).

NOTE: The **SCU-38** External GPS Antenna is always more preferred than the internal GPS antenna.

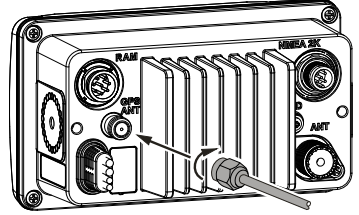

8.5.7 Optional SSM-70H (RAM4) Microphone

The transceiver is capable of using an **SSM-70H (RAM4)** Remote Station Microphone to control all the Radio functions. In addition, the transceiver can operate as a full function intercom system between the **SSM-70H** microphone and the transceiver.

WARNING

Do not connect or remove the SSM-70H (RAM4) microphone while the radio is powered ON. This may result in equipment failure.

1. Connect the Routing Cable (supplied with the **SSM-70H**) to the RAM connector (eight pins) on the rear panel, then tighten the cable nut (see the below illustration).

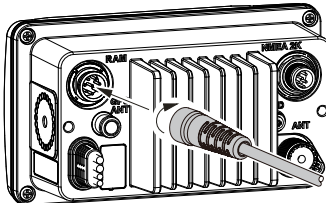

2. Install the two ferrite cores (supplied with the **SSM-70H** Remote Station Microphone) to the routing cable or the **CT-100** extension cable, then snap the halves together. These cores should be installed near the connectors of the transceiver and the microphone ends of the cable.
3. Attach the ferrite cores as close as possible to the plugs, as shown below.

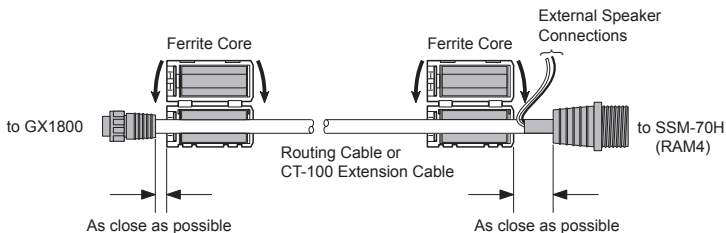

NOTE

Caution!: Before cutting the cable, it must be disconnected from the rear panel of the transceiver.

The routing cable can be cut and spliced, however care needs to be taken when reconnecting the wires to ensure water integrity.

After cutting you will notice there are the following wires:
Yellow, Green, White, Brown and Red/Shield

4. Finally, wind some plastic tape around each ferrite core, to prevent vibration from causing the two halves to split apart.
5. Referring to the illustration at the right, make a 30 mm hole in the wall, then insert the extension cable into this hole. Connect the gasket and mount base to the extension cable connector using the nut.
6. Drill the four screw holes (approx. 2 mm) into the wall, then install the mounting base to the wall using four screws.
7. Put the rubber cap onto the nut. The installation is now complete.

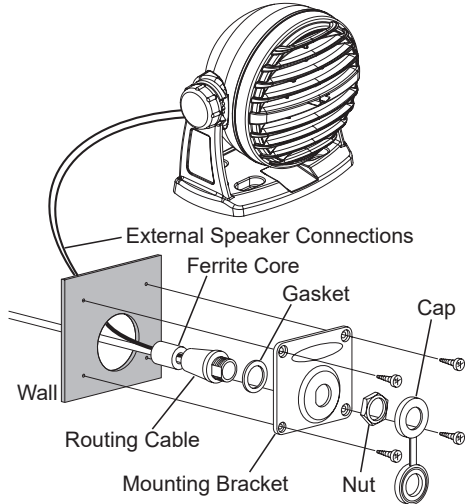

WARNING

It is not recommended to plug or unplug the **SSM-70H (RAM4)** Remote Station Microphone into the routing cable while the radio is powered **ON**.

Connecting an External Speaker to the RAM4 Mic Cable

In noisy locations and the **MLS-300** optional external speaker may be connected to the white speaker wires on the **RAM4** routing cable. The **RAM4** can drive either the internal speaker or the external speaker one at a time. When connecting an external speaker, follow the procedure below to turn the **RAM4** audio OFF and enable the external speaker connected to the **RAM4** routing cable wires.

1. On the **RAM4** microphone, press and hold the [MENU] key.
2. Rotate the **DIAL/ENT** knob to select “**CONFIGURATION**”, then press the [SELECT] soft key.
3. Rotate the **DIAL/ENT** knob to select “**SPEAKER SELECT**”, then press the [SELECT].



- Rotate the **DIAL/ENT** knob to select “**INTERNAL**” or “**EXTERNAL**”, then press the [**SELECT**] soft key.

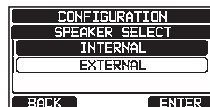

- Press the [**CLEAR**] key to return to radio operation.

8.6 INITIAL SETUP REQUIRED WHEN TURNING ON THE POWER FOR THE FIRST TIME

8.6.1 Maritime Mobile Service Identity (MMSI)

What is an MMSI?

An MMSI is a nine-digit number used on marine transceivers capable of using Digital Selective Calling (DSC) signal transmission. This number is used like a telephone number to selectively call other vessels.

THIS NUMBER MUST BE PROGRAMMED INTO THE RADIO TO OPERATE DSC FUNCTIONS.

How can I obtain an MMSI assignment?

Contact the Radio Licensing Authority for your country for information on obtaining an MMSI number.

WARNING

The MMSI can be input only once, be careful not to input the incorrect MMSI number. If the MMSI number needs to be reset, contact Standard Horizon to obtain the required reset code. Refer to section “**15.6.1 Reset the USER MMSI and ATIS CODE**”.

Programming the MMSI

- Press the [**MENU/SET**] key to display “**MENU**”.
- Press the [**▲**] or [**▼**] key to select “**MMSI/POS INFO**”, then press the [**SELECT**] soft key. (To cancel, press the [**BACK**] soft key.)



- The “**MMSI INPUT**” screen is displayed if the MMSI has not yet been input.

When the transceiver entry has been completed, it is only possible to check the MMSI on this screen.

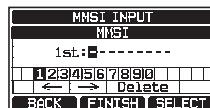

- Press the [**▲**]/[**▼**]/[**◀**]/[**▶**] keys to select the first number of your MMSI, then press the [**SELECT**] soft key to step to the next number.

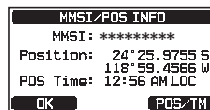

5. Repeat step 4 to set your MMSI number (9 digits).
If a mistake is made entering in the MMSI number, press the [▲]/[▼]/[◀]/[▶] keys to select “←” or “→”, press the [SELECT] soft key until the incorrect character is selected, then perform step 4.
6. When finished programming the MMSI number, press the [FINISH] soft key. The radio will ask you to input the MMSI number again. Perform steps 4 through 6 above.
7. After the second number has been input, press the [FINISH] soft key to store the MMSI.
8. Press the [OK] soft key to return to radio operation.

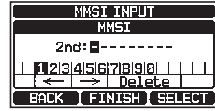

NOTE

To check the MMSI after programming to ensure it is correct, perform steps 1 to 2. The current MMSI number is shown on the display.

8.7 CONFIRMING GPS SIGNAL (GPS STATUS DISPLAY)

When the **GX1850/GX1800** series receives the GPS signal from the internal GPS receiver or the NMEA 2000 or NEMA 0183, an icon will appear on the display as shown below.

Receive GPS signal from	GX1850GPS GX1850GPS/E	GX1850	GX1800GPS GX1800GPS/E	GX1800
Internal GPS Receiver		—		—
NMEA 0183	I/O	I/O	I/O	
NMEA 2000	2K	2K	—	—

If there is a problem with the NMEA connection between the radio and the GPS, the GPS icon will blink continuously until the connection is corrected.

NOTE

Using the GPS position information from an external source (NMEA 0183 or NMEA 2000) is preferred, rather than relying on the internal GPS receiver. To check the status of the Internal GPS receiver, do not input signals from the external device.

The transceiver has a GPS status display which shows the satellites currently being received, along with a graphical (bar-graph) representation of the relative signal strengths from the satellites.

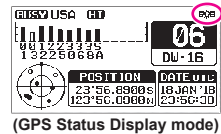

NOTE

When the GPS reception is limited, such as the flush mounting of the **GX1850GPS**, **GX1850GPS/E**, **GX1800GPS** and **GX1800GPS/E**, it is recommended to connect the optional External GPS Antenna **SCU-38** to the GPS ANT connector on the rear panel.

1. Press the **[MENU/SET]** key to display “**MENU**”.
2. Press the **[▲]** or **[▼]** key to select “**GPS**”, then press the **[SELECT]** soft key.
3. Press the **[▲]** or **[▼]** key to select “**GPS STATUS**”, then press the **[ENTER]** soft key to display the GPS status currently being received.
4. Press the **[CLEAR]** key to return to radio operation.

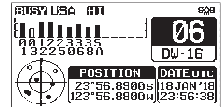
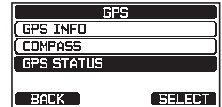
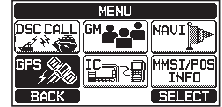

NOTE

For the transceiver to properly show the GPS status page when an external GPS receiver or a chart plotter is connected, the external device must be setup to output GSA and GSV NMEA 0183 sentences. When using the equipment of NMEA 2000, it must be able to output PGN No.129540 (GNSS Sats in View).

8.8 GPS CONFIGURATION

8.8.1 Setting the GPS Time

The transceiver shows GPS satellite time or UTC (Universal Time Coordinated) time in factory default. A time offset is needed to show the local time in your area. The time offset must be changed in order for the radio to display the current time in your area.

1. Press and hold the **[MENU/SET]** key.
2. Press the **[▲]** or **[▼]** key to select “**GPS SETUP**”, then press the **[SELECT]** soft key.
3. Press the **[▲]** or **[▼]** key to select “**TIME OFFSET**”, then press the **[SELECT]** soft key.



- Press the [▲] or [▼] key to select time offset of your location. If “00:00” is assigned, the time is the same as UTC or GPS satellite time.



- Press the [ENTER] soft key to store the time offset.
- Press the [CLEAR] key to return to radio operation.

8.8.2 Setting the Time Area

This menu selection allows the transceiver to show UTC time or local time with the offset.

- Press and hold the [MENU/SET] key.
- Press the [▲] or [▼] key to select “GPS SETUP”, then press the [SELECT] soft key.
- Press the [▲] or [▼] key to select “TIME AREA”, then press the [SELECT] soft key.
- Press the [▲] or [▼] key to select “UTC” or “LOCAL”.
- Press the [ENTER] soft key to store the selected setting.
- Press the [CLEAR] key to return to radio operation.

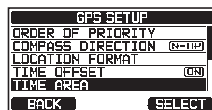
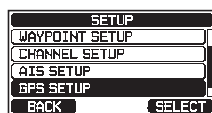

8.8.3 Setting the Time Format

This menu selection allows the transceiver to be setup to show time in 12-hour or 24-hour format.

- Press and hold the [MENU/SET] key.
- Press the [▲] or [▼] key to select “GPS SETUP”, then press the [SELECT] soft key.
- Press the [▲] or [▼] key to select “TIME FORMAT”, then press the [SELECT] soft key.
- Press the [▲] or [▼] key to select “24hour” or “12hour”.
- Press the [ENTER] soft key to store the selected setting.
- Press the [CLEAR] key to return to radio operation.

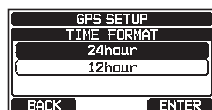
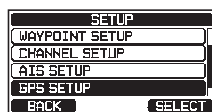

8.8.4 Setting COG to True or Magnetic

The GPS COG (Course Over Ground) and the BRG from a Waypoint Target magnetic variation may be selected to show in ON or OFF. Factory default is “OFF” however by following the steps below the COG can be changed to “ON”.

1. Press and hold the [MENU/SET] key.
2. Press the [▲] or [▼] key to select “GPS SETUP”, then press the [SELECT] soft key.
3. Press the [▲] or [▼] key to select “MAGNETIC VARIATION”, then press the [SELECT] soft key.
4. Press the [▲] or [▼] key to select “OFF” or “ON”.
5. Press the [ENTER] soft key to store the selected setting.
6. Press the [CLEAR] key to return to radio operation.

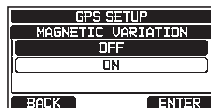
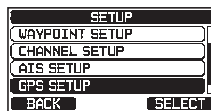



NOTE



The “ON” setting is effective only when the RMC sentences with magnetic data are input from external devices such as a GPS Chart Plotter.

9 BASIC OPERATION

9.1 TURNING THE TRANSCEIVER ON AND OFF

1. After the transceiver has been installed, ensure that the power supply and antenna are properly connected.
2. Press and hold the  key to turn the radio ON.
3. Press and hold the  key again to turn the radio OFF.

9.2 RECEPTION

1. Rotate the **SQL** knob fully counterclockwise. This state is known as “squelch off”.
2. Turn up the **VOL** knob until noise or audio from the speaker is at a comfortable level.
3. Rotate the **SQL** knob, clockwise until the random noise disappears. This state is known as the “squelch threshold”.
4. Press the [] or [] key to select the desired channel. Refer to the channel chart on page 109 for available channels.
5. When a signal is received, adjust the volume to the desired listening level. The **BUSY** Indicator Lamp glows green, and the “**BUSY**” indicator on the display indicates that communications are being received.

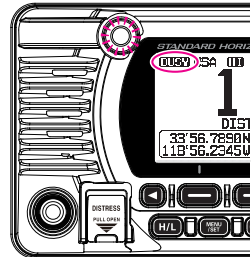

9.3 TRANSMISSION

1. Perform steps 1 through 4 of RECEPTION.
2. Before transmitting, monitor the channel to ensure it is clear.

THIS IS AN FCC REQUIREMENT!

3. Press the microphone's **PTT** (push-to-talk) switch. The “**TX**” indicator on the LCD is displayed.
4. Speak slowly and clearly into the microphone.
5. When the transmission is finished, release the microphone **PTT** switch.

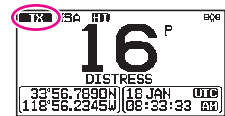

NOTE

Position your mouth about 2 cm away from the microphone and speak in a normal voice.

9.3.1 Transmit Power

The TX output power of the transceiver is set to high (25 W) in factory default, and the “HI” indicator is displayed on the top part of the screen.

To switch the TX output power:

1. Press the [H/L] key on the front panel or the microphone to switch between HI (25 W) or LO (1 W) output power.

NOTE: When the TX output power is set to “Low” while the transceiver is on channel 13 or 67 (USA Channel group only), the output power will temporarily switch from “Low” to “High” power until the PTT switch of the microphone is released. This soft key is not function on transmit inhibited and low power only channels.



9.4 BASIC OPERATION OF THE SETUP MENU

Using the setup menu, the various functions of the transceiver can be customized to match the user's needs and preferences. Items to be adjusted may be selected from the respective lists and the appropriate settings made for the various intended operations.

1. Press and hold the [MENU/SET] key on the operation mode screen.
2. Press the [▲] or [▼] key to select the function item, then press the [SELECT] soft key.
3. Press the [▲] or [▼] key to select the setting item, then press the [SELECT] soft key.
4. Press the [▲] or [▼] key to select the desired setting.
5. Press the [ENTER] soft key to store the selected setting.
6. Press the [CLEAR] key to return to radio operation. (The display can also be returned to the previous screen by pressing the [BACK] soft key.)

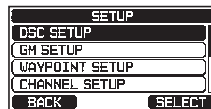

The above process is used when making the Setup Menu adjustments that follow in this Operating Manual.

Press & hold [MENU/SET] → “DSC SETUP” → “INDIVIDUAL DIRECTORY”

9.5 TRANSMIT TIME-OUT TIMER (TOT)

When the **PTT** switch on the microphone is held down, transmit time is limited to 5 minutes. This limits unintentional transmissions due to a stuck microphone. About 10 seconds before automatic transmitter shutdown, a warning beep will be heard from the speaker(s). The transceiver will automatically go to receive mode, even if the **PTT** switch is continually held down. Before transmitting again, the **PTT** switch must first be released and then pressed again.

NOTE

Once the transmitter is shut down by the TOT, transmission on the channel is only allowed 10 seconds after the shutdown.

9.6 SIMPLEX/DUPLEX CHANNEL USE

Refer to the **VHF MARINE CHANNEL CHART** (Page 109) for instructions on use of simplex and duplex channels.

NOTE

All channels are factory-programmed in accordance with FCC (USA), ISED (Canada), and International and region regulations. Mode of operation cannot be altered from simplex to duplex or vice-versa.

9.7 CHANNEL GROUP

Set the Channel Group according to the region:

1. Press & hold  → “**CHANNEL SETUP**” → “**CHANNEL GROUP**”

2. Press the **[▲]** or **[▼]** key to select the desired channel group “**USA**”, “**INTL**”, or “**CAN**”^{*1}.

^{*1}In the European version, when setting the region, the selected European Channel Group will be displayed instead of “**CAN**” group. For details, refer to the “Note on the Setting the Region” on the separate yellow insert sheet.



3. Press the **[ENTER]** soft key to store the selected setting.

4. Press the **[CLEAR]** key to return to radio operation.

Refer to the “**22 CHANNEL ASSIGNMENTS**” (page 109) for allocated channels in each mode.

9.8 NOAA WEATHER CHANNELS (in USA and Canada only)

1. To receive a NOAA weather channel, press one of the soft keys, then press the [◀] or [▶] key repeatedly until the [WX] soft key is displayed at the bottom of the screen.



2. Press the [WX] soft key.

The “WX” indicator appears on the top part of the screen.

Note: To receive a NOAA weather channel, assign the “WX” command into one of the soft keys, refer to section “15.5 SOFT KEYS”.

3. Press the [▲] or [▼] key to select a different NOAA weather channel.
4. To exit from the NOAA weather channels, press one of the soft keys, then press the [CH] soft key. The transceiver returns to the channel it was on prior to a weather channel and the “WX” indicator disappears from the display.

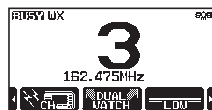

9.8.1 NOAA Weather Alert (USA version only)

In the event of extreme weather disturbances, such as storms and hurricanes, the NOAA (National Oceanic and Atmospheric Administration) sends a weather alert accompanied by a 1050 Hz tone and transmits a subsequent weather report on one of the NOAA weather channels.

The GX1850GPS, GX1850, GX1800GPS and GX1800 can receive weather alerts when monitoring a weather channel and on the last selected weather channel during scanning modes or while monitoring a working channel.

To enable the weather alert function, refer to section “16.2 WEATHER ALERT (USA version only)”.

When an alert is received on a NOAA weather channel, scanning will stop and the transceiver will emit a loud beep to alert the user of a NOAA broadcast. Press any key to stop the alert. After stopping the beep sound, the weather alert reception confirmation screen will appear. Press [OK] to display a confirmation screen. The confirmation screen will ask you whether to move to the weather channel or return in the marine channel. Press [YES] to switch to the weather channel, and press [NO] to return to the marine channel.

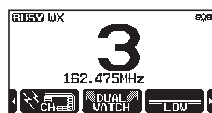

NOTE

If no key is pressed the alert will sound for 5 minutes and then the weather report will be received.

9.8.2 NOAA Weather Alert Testing

NOAA tests the alert system every Wednesday between 11AM and 1PM. To test the NOAA weather feature, setup the transceiver as in section “9.8.1 NOAA Weather Alert (USA version only)” and confirm the alert is heard on Wednesdays between 11AM and 1PM local time.

9.9 MULTI WATCH (TO PRIORITY CHANNEL)

Multi watch is used to scan two or three channels for communications.

- In Dual Watch, a normal VHF channel and the priority channel are scanned alternately.
- In Triple Watch, a normal VHF channel, the priority channel, and the sub channel are scanned alternately.

When a signal is received on the normal channel the radio briefly switches between the normal channel and the priority channel to look for a transmission. If the radio receives communications on the priority channel the radio stops and listens to priority channel until communication ends and then starts dual or triple watch scan again.

9.9.1 Setup the Multi Watch Operation

1. Press & hold  → “CHANNEL SETUP” → “MULTI WATCH”

2. Press the [▲] or [▼] key to select “DUAL” or “TRIPLE”.
3. Press the [ENTER] soft key to store the selected setting.
4. Press the [CLEAR] key to return to radio operation.

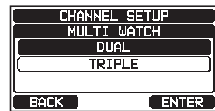

9.9.2 Starting Dual Watch

1. Adjust the **SQL** knob until the background noise disappears.
2. Press the [▲] or [▼] key to select a channel you wish to watch.
3. Press one of the soft keys.
4. Press [◀] or [▶] key repeatedly until the [DUAL WATCH] soft key is displayed at the bottom of the screen, press the [DUAL WATCH] soft key.



The radio will monitor the priority channel and the channel that was selected in step 2. If a signal is received on the channel selected in step 2, the transceiver will dual watch to priority channel.

5. To stop dual watch, press the [DUAL WATCH] soft key again.

When selecting “TRIPLE” in the SETUP menu, [TRIPLE WATCH] will be displayed as the soft key instead of [DUAL WATCH].

NOTE

The priority channel or the sub channel may be changed from CH16 (default) or CH9 (default) to another channel. Refer to section “16.7 PRIORITY CHANNEL” or “16.8 SUB CHANNEL”.

9.10 SCANNING

The transceiver will automatically scan channels programmed into the preset channel memory and also the scan channel memory, and the last selected weather channel.

When an incoming signal is detected on one of the channels during scan, the radio will pause on that channel, allowing you to listen to the incoming transmission. The radio will automatically start scanning again after the transmission stops.

9.10.1 Selecting Scan Type

1. Press & hold  ►► “CHANNEL SETUP” ►► “SCAN TYPE”
2. Press the [▲] or [▼] key to select “PRIORITY” or “MEMORY”.
3. Press the [ENTER] soft key to store the selected setting.
4. Press the [CLEAR] key to return to radio operation.

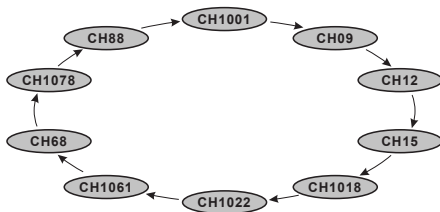
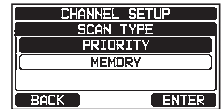

Memory Scan (M-SCAN)

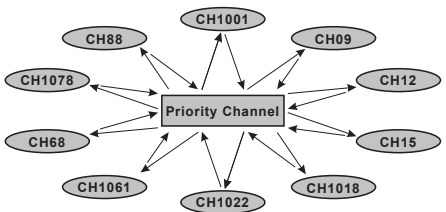

Priority Scan (P-SCAN)

9.10.2 Programming Scan Memory

1. Press & hold  ►► “CHANNEL SETUP” ►► “SCAN MEMORY”
2. Press the [▲] or [▼] key to select a desired channel to be scanned, then press the [MEM] soft key. The “ON” icon will appear at the right side of the selected channel.
3. Repeat step 2 for all the desired channels to be scanned.



- To REMOVE a channel from the list, select the channel then press the [MEM] soft key. The “ON” icon of the selected channel will disappear.
- When you have completed your selection, press the [CLEAR] key to return to radio operation.

To check the channels to be scanned, Press the [▲] or [▼] key. The “MEM” icon will appear when the memory channel is displayed.

NOTE: When “SCAN MEMORY” is assigned to the soft key, the memory function switches between ON and OFF each time the [MEM] soft key is pressed.



9.10.3 Memory Scanning (M-SCAN)

- Set the scan type to “MEMORY” in the SETUP menu (refer to “9.10.1 Selecting Scan Type”).
- Adjust the SQL knob until the background noise disappears.
- Press one of the soft keys.

- Press the [◀] or [▶] key repeatedly, then press the [SCAN] soft key. The “MEM SCAN” icon appears on the display. Scanning will proceed from the lowest to the highest programmed channel number and the preset channel (described in the next section). Scanning will stop on a channel when a transmission is received.



The channel number will blink during reception.

- To stop scanning, press the [SCAN] soft key, [16/S] or [CLEAR] key.

9.10.4 Priority Scanning (P-SCAN)

- Set the scan type to “PRIORITY” in the SETUP menu (refer to “9.10.1 Selecting Scan Type”).
- Adjust the SQL knob until the background noise disappears.
- Press one of the soft keys.

- Press the [◀] or [▶] key repeatedly, then press the [SCAN] soft key. The “PRI SCAN” icon appears on the display. Scanning will proceed between the memorized channels, the preset channel (described in next section) and the priority channel.



The priority channel will be scanned after each programmed channel.

- To stop scanning, press the [SCAN] soft key, [16/S] or [CLEAR] key.

NOTE

In the default setting, Channel 16 is set as the priority channel. You may change the priority channel from Channel 16 to another desired channel using the SETUP menu. Refer to section “16.7 PRIORITY CHANNEL”.

9.11 PRESET CHANNELS: INSTANT ACCESS

10 preset channels can be programmed for instant access. Pressing the [PRESET] soft key activates the user assigned channel bank. If the [PRESET] soft key is pressed and no channels have been assigned, an error beep will sound.

Before beginning the Instant Access operation, assign the “PRESET” command into one of the programmable keys, refer to section “15.5 SOFT KEYS”.

9.11.1 Programming

1. Press the [▲] or [▼] key to select the channel to be programmed.
2. Press one of the soft keys.
3. Press the [◀] or [▶] key repeatedly, until the [PRESET] soft key is displayed, then press and hold the [PRESET] soft key until the “P-SET” icon and channel number are blinking.
4. Press the [ADD] soft key to program the channel into the preset channel memory. The “P-SET” icon will appear.
5. Repeat steps 1 through 3 to program the desired channels into the preset channels. Up to 10 channels can be registered. If you attempt to register the 11th channel, an error beep will sound.



9.11.2 Operation

1. Press one of the soft keys.
2. Press the [◀] or [▶] key repeatedly, then press the [PRESET] soft key to recall the preset channel. The “P-SET” icon will appear on the display.
3. Press the [▲] or [▼] key to select the desired preset channel.
4. Press the [PRESET] soft key to return to the last selected channel. The “P-SET” icon will disappear from the display.



9.11.3 Deletion

1. Press one of the soft keys.
2. Press the [◀] or [▶] key repeatedly, then press the [P-SET] soft key to recall the preset channel
3. Press the [▲] or [▼] key to select the preset channel to be deleted.
4. Press one of the soft keys, then press and hold the [PRESET] soft key until the “P-SET” icon and channel number are blinking.
5. Press the [DELETE] soft key to delete the channel from the preset channel memory.
6. Repeat steps 3 through 5 to delete the undesired channels from preset channels.
7. To exit from deleting the preset channels, press the [QUIT] soft key.



9.12 MOB OPERATION

The **GX1850/GX1800** series provides a feature to memorize the position information instantly in case of MOB (Man Over-Board).

1. Press one of the soft keys.
2. Press the [◀] or [▶] key repeatedly, then press the [MOB] soft key.
3. Press the [TO WPT] soft key to start the navigation to the displayed position. For details about the navigation, see section “12 NAVIGATION”.
To change the displayed position information, press the [POS/TM] soft key. For details about modification of the position, see “Editing a Waypoint” on page 70.
4. To transmit a DSC distress message, lift the red spring loaded DISTRESS cover on the right side of the transceiver, then press and hold the **DISTRESS** key (see section “11.2.1 Transmitting a Distress Alert” for details).

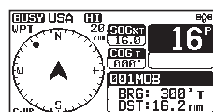

9.13 INTERCOM OPERATION

The optional **SSM-70H (RAM4)** remote station microphone must be connected to perform intercom functions between the transceiver and the **SSM-70H (RAM4)**.

NOTE

When using the intercom function, connect **SSM-70H (RAM4)** Remote Station Microphone to the transceiver.

9.13.1 Communication

1.  → "IC"

2. When the intercom mode is enabled, "INTERCOM" is displayed on the radio and **SSM-70H (RAM4)**.
3. Press the transceiver microphone PTT switch, "Talk" will be shown on the display.

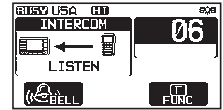

- NOTE:** A warning beep will be heard when the transceiver **PTT** and **RAM4 PTT** switches are pushed at the same time.
4. Speak slowly and clearly into the microphone, hold the microphone about 1.5 cm away from your mouth.
 5. When finished, release the **PTT** switch.
 6. Press the **[CLEAR]** key to return to radio operation.

9.13.2 Calling

When in intercom mode, pressing the **[BELL]** soft key on either the radio or **RAM4** microphone will produce a calling beep to the other station.

9.14 DEMO MODE

This mode is used by Standard Horizon sales persons and dealers to demonstrate the transceiver's DSC functions. Demo mode allows latitude, longitude and time to be entered manually to simulate the displays. When the demo mode is enabled, the transceiver will automatically switch from the NORMAL, COMPASS, WAYPOINT and GM displays.

NOTE

When demo mode is enabled, if the transceiver is turned OFF and back ON it will still be in the demo mode.

1. Press & hold  → "ABOUT..." → "DEMO OPERATION"

2. Press the [▲] or [▼] key to select “**DEMO POSITION INPUT**”, then press the [SELECT] soft key.

3. Enter the latitude and longitude of your vessel and your local UTC time in the 24-hour notation using the [▲] and [▼] keys. Press the [▲]/[▼]/[◀]/[▶] keys to select the number and press the [SELECT] soft key to move the cursor to the next character.



4. If a mistake is made while entering the latitude, longitude or local UTC time of your vessel, you can use the [▲]/[▼]/[◀]/[▶] keys to select “←” or “→”, press the [SELECT] soft key until the incorrect character is selected, then perform step 2 to make the correction.

5. To store the data entered, press the [FINISH] soft key.

6. Press the [▲] or [▼] key to select “**DEMO START**”, then press the [SELECT] soft key.



7. Press the [▲] or [▼] key to select “**START**”, then press the [ENTER] soft key.



NOTE

To exit the demo mode, select “**STOP**” in step 7 above.

10 GPS OPERATION

The **GX1850GPS**, **GX1850GPS/E**, **GX1800GPS** and **GX1800GPS/E** has an internal GPS receiver to acquire and display the satellite position information*. When the radio is connected to an external GPS device by the NMEA-0183 or NMEA2000, you may select the order of priority of the connection devices to be used when obtaining location information via the SETUP menu (Refer to section “18.1 ORDER OF PRIORITY (GX1850 series only)”). Your position information as well as received positions can be memorized and utilized later for navigation.

*(The **GX1850** and **GX1800** requires input of GPS coordinates from an external GPS device.)

10.1 DISPLAYING POSITION INFORMATION

10.1.1 GPS Information Numerical Display

1.  → “GPS” → “GPS INFO”

2. The numerical data is displayed.
3. Press the [CLEAR] key to return to radio operation.

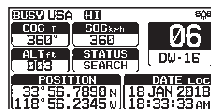

10.1.2 GPS Information Compass Display

1.  → “GPS” → “COMPASS”

2. The compass data is displayed.
3. Press the [CLEAR] key to return to radio operation.
NOTE: Depending on the assignment of the soft keys you may switch the screen immediately from the basic display to the compass display by pressing the [COMP] soft key.

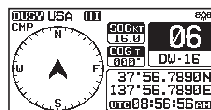

10.2 CHECKING GPS STATUS

1.  → “GPS” → “GPS STATUS”

2. Display the GPS status currently being received.
3. Press the [CLEAR] key to return to radio operation.

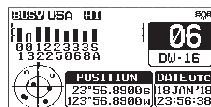

11 DIGITAL SELECTIVE CALLING (DSC)

11.1 GENERAL

WARNING

This **GX1850/GX1800** series is designed to generate a digital maritime distress and safety call to facilitate search and rescue. To be effective as a safety device, this equipment must be used only within communication range of a shore-based VHF marine channel 70 distress and safety watch system. The range of signal may vary but under normal conditions should be approximately 20 nautical miles.

Digital Selective Calling (DSC) is a semi-automated method of establishing a radio call, it has been designated by the International Maritime Organization (IMO) as an international standard for establishing VHF, MF and HF radio calls. It has also been designated as part of the Global Maritime Distress and Safety System (GMDSS). It is planned that DSC will eventually replace aural watches on distress frequencies and will be used to announce routine and urgent maritime safety information broadcasts.

This system allows mariners to instantly send a distress call with its own position, to the Coast Guard and other vessels within range of the transmission. DSC will also allow mariners to initiate or receive Distress, Urgency, Safety, Routine, Position Request, Position Report, Automatic Position Polling, and Group calls to or from another vessel equipped with a DSC transceiver.

11.2 DISTRESS ALERT

The **GX1850/GX1800** series is capable of transmitting and receiving DSC distress messages. Distress alerts transmitted from the transceiver include the latitude and longitude of the vessel when valid GPS position data is being received.

11.2.1 Transmitting a Distress Alert

NOTE

To be able to transmit a DSC distress alert, the MMSI number must be programmed, refer to section “**8.6.1 Maritime Mobile Service Identity (MMSI)**”.

In order for the ships location to be transmitted, the **GX1850/GX1800** series must receive valid position data from the internal GPS receiver or another GPS device connected with a NMEA 0183 or NEMA 2000 network. Refer to section “**8.5.2 Accessory Cables**”.

Basic Operation

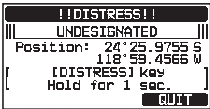
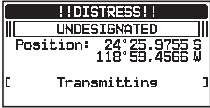
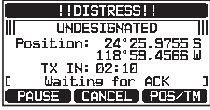
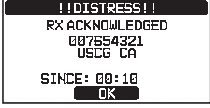
1. Lift the red spring loaded **[DISTRESS]** cover, then press and hold the **[DISTRESS]** key for 3 seconds. The radio display will count down (3-2-1) and then transmit the distress alert. The backlight of the display and keypad flashes while the radio's display is counting down.
 
2. When the distress signal is sent, the transceiver watches for a transmission on CH70 until an acknowledgment signal (distress acknowledgement) is received.
 
3. If no acknowledgment is received, the distress alert is repeated in 4-minute intervals until an acknowledgment is received.
 
4. When a distress acknowledgment is received, a distress alarm sounds and Channel 16 is automatically selected. The display shows the MMSI of the ship responding to your distress.
 
5. Press the microphone **PTT** switch and state your name, vessel name, number of persons on board and the distress situation, then say “**over**” and wait for a reply from the acknowledging ship.
6. To turn the distress alarm OFF before the radio retransmits the distress alert, press the **[16/S]** key or the **[QUIT]** soft key.

Transmitting a Distress Alert with Nature of Distress

The transceiver is capable of transmitting a distress alert with the following “Nature of Distress” categories:

Undesignated, Fire/Explosion, Flooding, Collision, Grounding, Capsizing, Sinking, Adrift, Abandoning, Piracy, MOB.

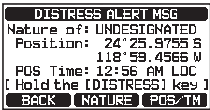
1.  → “**DSC CALL**” → “**DIST ALERT MSG**”
 
2. Press the **[NATURE]** soft key. The “**NATURE OF**” menu will appear on the display.
3. Press the **[▲]** or **[▼]** key to select the desired nature of distress category, then press the **[SELECT]** soft key.
4. Press and hold the **DISTRESS** key until a distress alert is transmitted.

Transmitting a Distress Alert by Manually Inputting Location and Time

In case the transceiver fails to get a GPS position fix, you may manually input the latitude, longitude and time before transmitting the distress alert.

1.  → "DSC CALL" → "DIST ALERT MSG"

2. Press the **[POS/TM]** soft key.

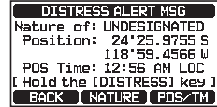

3. Press the **[▲]/[▼]/[◀]/[▶]** keys to select the first number of the latitude, then press the **[SELECT]** soft key to step to the next number.

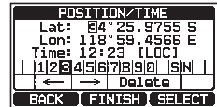

4. Repeat step 3 to set the position and time.

If a mistake is made, press the **[▲]/[▼]/[◀]/[▶]** keys to select "←" or "→", press the **[SELECT]** soft key until the incorrect character is selected, then perform step 3.

5. When finished programming the position and time, press the **[FINISH]** soft key. The display will return to the previous screen.

6. Press and hold the **[DISTRESS]** key until a distress alert is transmitted.

Pausing a Distress Alert

After a distress alert is transmitted, the distress alert is repeated every 4 minutes until the call is canceled by the user or until the radio is turned OFF and ON again. The transceiver has the capability to suspend (pause) the retransmitting of the distress alert by the procedure below.

1. After the distress alert is transmitted, the radio will show the display as on the right.

Looking at this display you will notice "TX IN: 02:10", this is the time when the radio will re-transmit the distress alert.

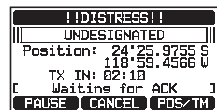

2. To suspend re-transmitting the distress alert call, press the **[PAUSE]** soft key.

3. To resume counting down to transmit the distress alert, press the **[RESUME]** soft key.

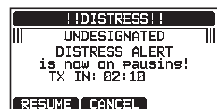

Canceling a Distress Alert

If a distress alert was sent by error, the transceiver allows you to send a message to other vessels to cancel the distress alert that was made.

1. Press the [**CANCEL**] soft key, then press the [**YES**] soft key.
2. After the message for canceling has been transmitted, press the [**OK**] soft key.
3. Press the [**FINISH**] soft key.
4. Press the [**QUIT**] soft key to return to radio operation.

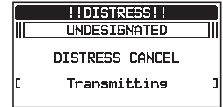
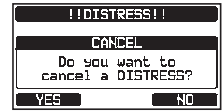

11.2.2 Receiving a Distress Alert

1. When a distress alert is received, an emergency alarm sounds.
2. Press any key to stop the alarm.
3. Press the [**▲**] or [**▼**] key to show information on the vessel in distress.

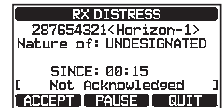
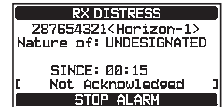

On the display you will notice 3 soft key selections. These selections are described below:

[**ACCEPT**]: Press this key to accept the distress alert and switch to Channel 16.

NOTE: If a key is not pressed within 30* seconds the radio will automatically switch to Channel 16. *(“**AUTO CHANNEL CHANGE**” timer settings can be changed in “DSC SETUP” menu. The default setting is 30 sec.)

[**PAUSE**]: Press this key to temporarily pause automatic switching to Channel 16.

[**QUIT**]: Press this key to end quit the automatic Channel 16 switching and revert to the last selected working channel.

4. After accepting the call, press the [**TO WPT**] soft key to set the location of the vessel in distress as a destination for navigation.

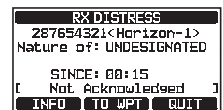

NOTE: You may change the waypoint name.

- Press the [▲] or [▼] key to select “**SAVE & GOTO**”, then press the [SELECT] soft key to change the display to the waypoint navigation screen. The display indicates the distance and direction of the vessel in distress, and the compass displays the distressed vessel with a dot (●).
- To stop navigating to a waypoint, press one of the soft keys, then press the [STOP] soft key. The radio is switched to the normal mode.

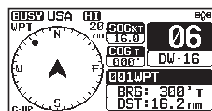
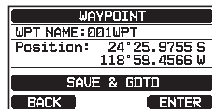

NOTE

- You must continue monitoring Channel 16 as a coast station may require assistance in the rescue attempt.
- When there is an unread distress alert, an “✉” icon will appear on the display. You may review the unread distress alert from the DSC log, refer to section “**11.10.2 Reviewing a Logged DSC RX Distress Alert and acknowledgement**”.

11.3 ALL SHIPS CALL

The all ships call function allows contact to be established with DSC equipped vessels without having their MMSI in the individual calling directory. Also, priority for the call can be designated as “**SAFETY**” or “**URGENCY**”.

SAFETY Call: This type of DSC call is used to transmit boating safety information to other vessels. This message usually contains information about an overdue boat, debris in the water, loss of a navigation aid or an important meteorological message. This call is the same as transmitting “Securite, Securite, Securite” by voice.

URGENCY Call: This type of call is used when a vessel may not truly be in distress, but have a potential problem that may lead to a distress situation. This call is the same as transmitting “PAN PAN, PAN PAN, PAN PAN” on Channel 16.

11.3.1 Transmitting an All Ships Call

-  → “**DSC CALL**” → “**ALL SHIPS**”

- Press the [▲] or [▼] key to select the nature of the call (“**SAFETY**” or “**URGENCY**”), then press the [SELECT] soft key.



- In the INTERSHIP CH list, press the [▲] or [▼] key to select the operating channel on which you want to communicate, then press the [SELECT] soft key. To select operating channels from all voice channels, press the [MANUAL] soft key.
- Press the [YES] soft key to transmit the selected type of all ships call.
- After the all ships call is transmitted, the transceiver will switch to the selected channel.
- Listen to the channel to make sure it is not busy, then key the microphone and say “PAN PAN, PAN PAN, PAN PAN” or “Securite, Securite, Securite” depending on the priority of the call.
- Press the [QUIT] soft key to exit the all ships call menu.

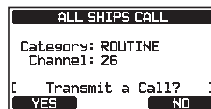
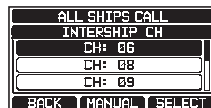

11.3.2 Receiving an All Ships Call

- When an all ships call is received, an emergency alarm will sound.

The display shows the MMSI of the vessel transmitting the all ships call and the radio will change to the requested channel after 30 seconds (the default setting of “AUTO CHANNEL CHANGE”).

- Press any key to stop the alarm.
- Monitor the requested channel until the all ships voice communication is completed.

On the display you will notice 3 soft key selections. These selections are described below:

[ACCEPT]: Press this key to accept the DSC all ships call and to switch to requested channel.

NOTE: If a key is not pressed for 30* seconds or longer the radio will automatically change to the requested channel.

*(The default setting of “AUTO CHANNEL CHANGE”)

[PAUSE]: Press this key to temporarily pause automatic switching to the requested channel.

NOTE: In some cases, automatically switching to the requested channel might disrupt important ongoing communications. Commercial users may suspend channel switching and remain on the working channel in use before the all ships call was received.



[QUIT]: Press this key to quit the automatic channel switching and revert to the last selected working channel.

- Press the [QUIT] key to return to the channel display.



NOTE

When there is an unread all ships call, an “✉” icon will appear on the display. You may review the unread all ships call from the DSC log, refer to section “11.10.2 Reviewing a Logged DSC RX Distress Alert and acknowledgement”.

11.4 INDIVIDUAL CALL

This feature allows the **GX1850/GX1800** series to contact another vessel with a DSC VHF radio and automatically switch the receiving radio to the desired communications channel. This feature is similar to calling a vessel on CH16 and requesting to go to another channel (switching to the channel is private between the two vessels). Up to 100 individual contacts may be programmed.

11.4.1 Setting up the Individual / Position Call Directory

The transceiver has a DSC individual directory that allows storing vessels or persons names and the associated MMSI numbers you may wish to contact via individual calls, auto polling, position request, position report, and polling transmissions. To transmit an individual call, you must program this directory with information of the persons you wish to call, similar to a cellular phone contact list.

- Press & hold → “DSC SETUP” → “INDIVIDUAL DIRECTORY”

- Press the [▲] or [▼] key to select “ADD”, then press the [SELECT] soft key.

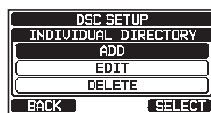

- Press the [▲] or [▼] key to select “NAME:”, then press the [SELECT] soft key.

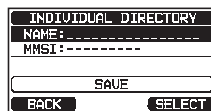

- Press the [▲]/[▼]/[◀]/[▶] keys to select the letters of the name of the vessel or person you want to reference in the directory.

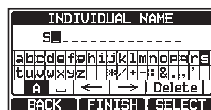

- Press the [SELECT] soft key to store the first letter in the name and step to the next letter to the right.

6. Repeat steps 4 and 5 until the name is complete. The name can consist of up to 11 characters, and if you do not use all 11 characters, select “→” to move to the next space. The “→” can also be used to enter a blank space in the name.
If a mistake is made entering in the name, press the [▲]/[▼]/[◀]/[▶] keys to select “←” or “→”, press the [SELECT] soft key until the incorrect character is selected, then perform steps 4 and 5.
7. When finished entering the name (using 11 characters or less), press the [FINISH] soft key to advance to the MMSI number entry.
8. Press the [▲] or [▼] key to select “MMSI:”, then press the [SELECT] soft key.
9. Press the [▲]/[▼]/[◀]/[▶] keys to select numbers, 0 - 9. To enter the desired number and move one space to the right by pressing the [SELECT] soft key. Repeat this procedure until all nine space of the MMSI number are entered. If a mistake is made entering in the MMSI number, press the [▲]/[▼]/[◀]/[▶] keys to select “←” or “→”, press the [SELECT] soft key until the incorrect character is selected, then perform step 9.
10. When finished entering the MMSI number, press the [FINISH] soft key.
11. To store the entered data, press the [▲] or [▼] key to select “SAVE”, then press the [ENTER] soft key.
12. To enter another individual address, repeat steps 2 through 11.
13. Press the [CLEAR] key to return to radio operation.



11.4.2 Setting up the Individual Call Reply

This menu item sets up the radio to manually (default setting) or automatically respond to a DSC individual call requesting you to switch to a working channel for voice communications. When “MANUAL” is selected the MMSI of the calling vessel is shown allowing you to see who is calling. This function is similar to caller ID on a cellular phone.

1. Press & hold [MENU/SET] → “DSC SETUP” → “INDIVIDUAL REPLY”

2. Press the [▲] or [▼] key to select “AUTO” or “MANUAL”.
3. Press the [ENTER] soft key to store the selected setting.
4. Press the [CLEAR] key to return to radio operation.



11.4.3 Enabling the Individual Call Acknowledgment

The radio can select either reply message “ABLE” (default) or “UNABLE” when the individual reply setting (described in the previous section) is set to “AUTOMATIC”.

1. Press & hold  ⇒ “DSC SETUP” ⇒ “INDIVIDUAL ACK.”

2. Press the [▲] or [▼] key to select “ABLE” or “UNABLE”.
3. Press the [ENTER] soft key to store the selected setting.
4. Press the [CLEAR] key to return to radio operation.

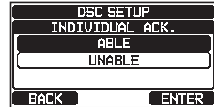

11.4.4 Transmitting an Individual Call

This feature allows the user to contact another vessel with a DSC transceiver, and is similar to calling a vessel on CH16 and requesting to go to another channel.

Individual Call using the Individual/Position Directory

1.  ⇒ “DSC CALL” ⇒ “INDIVIDUAL CALL”

2. Press the [▲] or [▼] key to select “HISTORY” or “MEMORY”, then press the [SELECT] soft key.

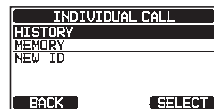

3. Press the [▲] or [▼] key to select an individual you want to contact, press the [SELECT] soft key.



4. In the INTERSHIP CH list, press the [▲] or [▼] key to select the operating channel on which you want to communicate, then press the [SELECT] soft key. To select operating channels from all voice channels, press the [MANUAL] soft key.

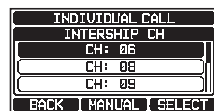

5. Press the [YES] soft key to transmit the individual DSC signal.

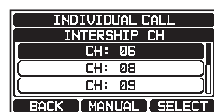

- When an individual call acknowledgment is received, the operating channel is automatically changed to the channel which is selected in step 4 above and a ringing tone sounds.
- Press the **[QUIT]** soft key to listen to the channel to make sure it is not busy, then press the microphone **PTT** switch and talk into the microphone to communicate with the other vessel.

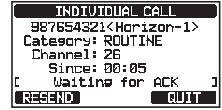
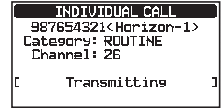

Individual Call by Manually Entering an MMSI

You may enter an MMSI contact number manually without storing it in the individual directory.

- "DSC CALL" → "INDIVIDUAL CALL"

- Press the **[▲]** or **[▼]** key to select "NEW ID", then press the **[SELECT]** soft key.

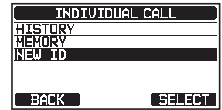

- Press the **[▲]/[▼]/[◀]/[▶]** keys to select the first number of the MMSI which you want to contact, then press the **[SELECT]** soft key to step to the next number.



- Repeat step 3 to set the MMSI number (nine digits). If a mistake is made while entering the MMSI number, press the **[▲]/[▼]/[◀]/[▶]** keys to select "←" or "→", press the **[SELECT]** soft key until the incorrect character is selected, then perform step 3 to enter the corrections.

- When finished entering the MMSI number, press the **[FINISH]** soft key.

- In the INTERSHIP CH list, press the **[▲]** or **[▼]** key to select the operating channel on which you want to communicate, then press the **[SELECT]** . To select operating channels from all voice channels, press the **[MANUAL]** soft key.

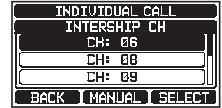

- Press the **[YES]** soft key to transmit the individual DSC call.

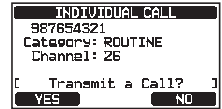

8. When an individual call acknowledgment is received, the operating channel is automatically changed to the channel which is selected in step 6 above and a ringing tone sounds.
9. Press the **[QUIT]** soft key to listen to the channel and make sure it is not busy, then press the microphone **PTT** switch and talk into the microphone to communicate with the other vessel.

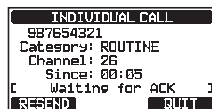
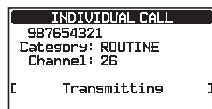

11.4.5 Receiving an Individual Call

When an individual DSC call is received, the MMSI (Maritime Mobile Service Identity Number) or person's name is displayed, you may choose whether or not to send your position to the requesting vessel. Refer to section "11.4.2 Setting up the Individual Call Reply" to change the reply to "AUTO" if you want to automatically replying to the call.

Manual reply (Default setting):

1. When an individual call is received, a ringing alarm sounds.

The display shows the MMSI of the vessel transmitting the individual call.



2. Press any key to stop the alarm.

3. The 3 soft key selections shown on the display are described below:

[ACCEPT]: Press this key to accept the DSC individual call, and switch to the requested channel.

[PAUSE]: Press this key to temporarily pause automatically switching to the requested channel.

NOTE: In some cases, automatically switching to a requested channel might disrupt important ongoing communications. Commercial users may suspend channel switching and remain on the working channel in use before the individual call was received.

[QUIT]: Press this key to exit the automatic channel switching and revert to the last selected working channel.

NOTE: If a key is not pressed within 30 seconds, the transceiver will automatically change to radio operation.

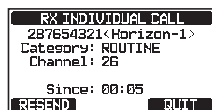

4. After accepting the call, press the **[ABLE]** soft key to switch to the requested channel. (To inform the calling vessel that you are unable to respond, press the **[UNABLE]** soft key.)



- Press the **[YES]** soft key to send an acknowledgement. Press the **[CHG CH]** soft key to change to the requested operating channel for communication.



- Monitor the specified channel until the message is completed. Press the microphone **PTT** switch and talk into the microphone to communicate with the vessel that initiated the individual call.
- Press the **[QUIT]** soft key to return to the channel display.



Automatic reply:

- When an individual call is received, a ringing alarm sounds. The radio automatically switches to the requested channel. The display shows the MMSI of the vessel calling.
- Press any key to stop the alarm.
- Monitor the requested channel until the message is completed. Press the microphone **PTT** switch and talk into the microphone to communicate with the vessel that initiated the individual call.
- Press the **[QUIT]** soft key to return to radio operation.



NOTE

When there is an unread individual call, the “” icon will appear on the display. You may review the unread individual call from the DSC log, refer to section “**11.10.2 Reviewing a Logged DSC RX Distress Alert and acknowledgement**”.

11.4.6 Setting up the Individual Call Ringer

When an individual call is received the call ringer will sound for 2 minutes (default setting). This selection allows the individual call ringer time to be changed.

- Press & hold **[MENU/SET]**  “DSC SETUP”  “INDIVIDUAL RING”

- Press the **[▲]** or **[▼]** key to select the individual call ringing time.
- Press the **[ENTER]** soft key to store the selected setting.
- Press the **[CLEAR]** key to return to radio operation.



The **GX1850/GX1800** series individual call ringer may be set to OFF:

1. [Press & hold ] → “DSC SETUP” → “DSC BEEP”

2. Press the [▲] or [▼] key to select “**INDIVIDUAL CALL**”, then press the [SELECT] soft key.



3. Press the [▲] or [▼] key to select “**OFF**”.

4. Press the [ENTER] soft key to store the selected setting.

5. Press the [CLEAR] key to return to radio operation.

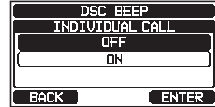

To enable the ringer tone, repeat the above procedure, press the [▲] or [▼] key to select “**ON**” in step 3 above.

11.5 GROUP CALL

This feature allows users to automatically contact a specific group of vessels using DSC radios with the group call function. The called radios can automatically switch to the desired channel for voice communications. This function is very useful for yacht clubs and vessels traveling together that want to make communal announcements on a predetermined channel. Up to 32 group MMSIs may be programmed.

11.5.1 Setting up a Group Call

For this function to operate, the same group MMSI (Maritime Mobile Service Identity Number) must be programmed into all the DSC VHF radios within the group of vessels that will be using this feature. To understand Group MMSI programming, first a ship MMSI has to be understood.

Ship MMSI: The first three digits called MID (Mobile Identity Group) of a ship MMSI denote the country where the ship’s MMSI is registered. The last 6 digits are specific to the ships ID.

Ship MMSI Example: If your MMSI is “366123456”, “366” is MID which denote the country and “123456” is the vessel’s MMSI.

Group MMSI:

- Group MMSI numbers are not assigned by the FCC or other organizations licensed to assign ship MMSI numbers.
- The first digit of a group MMSI is always set to “0” by International rules. All Standard Horizon radios are preset so when programming a group MMSI the first digit is set to “0”.
- The ITU (International Telecommunication Union) recommends programming the MID of a ship MMSI into the Second, Third and Fourth digits of the group MMSI as it denotes the area where the ship is located.

- ❑ The last 5 digits are decided upon by persons in the group. This is an important step as all radios in the group must contain the same group MMSI in order to be contacted by each other. There is a chance that another group of vessels may program the same group MMSI. If this happens, simply change one or more of the last 5 digits of the group MMSI.

1. [Press & hold ] ➔ “DSC SETUP” ➔ “GROUP DIRECTORY”

2. Press the [▲] or [▼] key to select “ADD”, then press the [SELECT] soft key.



3. Press the [▲] or [▼] key to select “GP NAME:”, then press the [SELECT] soft key.



4. Press the [▲]/[▼]/[◀]/[▶] keys to select the first letter of the name of the group you want to reference in the directory.



5. Press the [SELECT] soft key to store the first letter of the name and step to the next letter to the right.
6. Repeat steps 4 and 5 until the name is complete. The name can consist of up to 11 characters, if you do not use all 11 characters, select “→” to move to the next space. This method can also be used to enter a blank space in the name.

If a mistake is made entering the name, press the [▲]/[▼]/[◀]/[▶] keys to select “←” or “→”, press the [SELECT] soft key until the incorrect character is selected, then perform steps 4 and 5.

7. When finished entering the group name (using 11 characters or less), press the [FINISH] soft key to advance to the group MMSI number entry.

8. Press the [▲] or [▼] key to select “GP MMSI:”, then press the [SELECT] soft key.



9. Press the [▲]/[▼]/[◀]/[▶] keys to select the second number of the MMSI (the first of the nine digits is permanently set to “0”) which you want to contact, then press the [SELECT] soft key to step to the next number.

Repeat this procedure until all eight spaces of the MMSI number are entered. If a mistake is made entering in the MMSI number, press the [▲]/[▼]/[◀]/[▶] keys to select “←” or “→”, press the [SELECT] soft key until the incorrect character is selected, then perform step 9.

10. When finished entering the MMSI number, press the **[FINISH]** soft key to confirm.
11. To store the data, select “**SAVE**”, then press the **[SELECT]** soft key.
12. To enter another group address, repeat steps 2 through 11.
13. Press the **[CLEAR]** key to return to radio operation.

11.5.2 Transmitting a Group Call

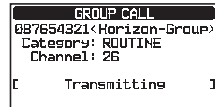
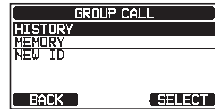

Group Call using the Group Directory

1.  → “**DSC CALL**” → “**GROUP CALL**”
2. Press the **[▲]** or **[▼]** key to select “**HISTORY**” or “**MEMORY**”, then press the **[SELECT]** soft key.
3. Press the **[▲]** or **[▼]** key to select a group you want to contact, then press the **[SELECT]** soft key
4. In the INTERSHIP CH list, press the **[▲]** or **[▼]** key to select the operating channel on which you want to communicate, then press the **[SELECT]** soft key. To select operating channels from all voice channels, press the **[MANUAL]** soft key.
5. Press the **[YES]** soft key to transmit the group call signal.
6. When the group call signal is sent, the display will be as shown in the illustration at the right.
7. After the group call is transmitted, all the radios in the group will switch to the designated channel.
8. Listen to the channel to make sure it is not busy, then press the microphone **PTT** switch to communicate with all of the vessels in the group.

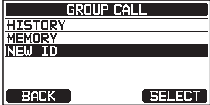

Group Call by Manually Entering an MMSI

This feature allows you to contact a group of vessels by entering in their group MMSI manually.

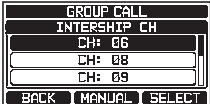
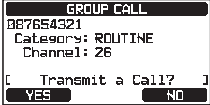
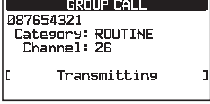
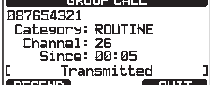
-  → "DSC CALL" → "GROUP CALL"
- Press the [▲] or [▼] key to select "NEW ID", then press the [SELECT] soft key.
- Press the [▲] or [▼] key to select the second number of the MMSI (the first of nine digits is permanently set to "0") which you want to contact, then press the [SELECT] soft key to step to the next number.
- Repeat step 3 to set the MMSI number.
If a mistake is made entering in the MMSI number, press the [▲]/[▼]/[◀]/[▶] keys to select "←" or "→", press the [SELECT] soft key until the incorrect character is selected, then perform steps 3 and 4.
- When finished entering the MMSI number, press the [FINISH] soft key.
- In the INTERSHIP CH list, press the [▲] or [▼] key to select the operating channel on which to communicate, then press the [SELECT] soft key. To select operating channels from all voice channels, press the [MANUAL] soft key.
- Press the [YES] soft key to transmit the group call signal.
- After the group call is transmitted, all the radios in the group will switch to the designated channel.
- Listen to the channel to make sure it is not busy, then press the microphone PTT switch to communicate with all of the vessels in the group.

11.5.3 Receiving a Group Call

1. When a group call is received, the transceiver will produce a ringing alarm sound.
2. The display shows the group MMSI number.
3. Press any key to stop the alarm.



On the display 3 soft key selections are shown. These selections are described below:



[ACCEPT]: Press this key to accept the group call and switch to the requested channel.

[PAUSE]: Press this key to temporarily pause automatic switching to the requested channel.

[QUIT]: Press this key to exit the automatic channel switching and revert to the last selected working channel.

4. If you want to respond, monitor the channel to make sure it is clear, then press the microphone **PTT** switch and talk into the microphone to communicate with all of the vessels in the group.
5. Press the **[QUIT]** soft key to return to radio operation.



NOTE: If a key is not pressed within 30 seconds, the radio will automatically change to radio operation.

NOTE

When there is an unread group call, the “” icon will appear on the display. You may review the unread group call from the DSC log, refer to section “11.10.3 Reviewing Other Logged Calls”.

11.5.4 Setting up the Group Call Ringer

The transceiver group call ringer may be turned OFF using the following procedure:

1. Press & hold  ⇒ “DSC SETUP” ⇒ “DSC BEEP”

2. Press the **[▲]** or **[▼]** key to select “GROUP CALL”, then press the **[SELECT]** soft key.



3. Press the **[▲]** or **[▼]** key to select “OFF”.
4. Press the **[ENTER]** soft key to store the selected setting.
5. Press the **[CLEAR]** key to return to radio operation.

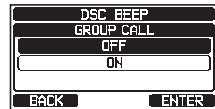

To enable the ringer tone, repeat the above procedure, pressing the **[▲]** or **[▼]** key to select “ON” in step 3 above.

11.6 POSITION REQUEST

Advancements in DSC have made it possible to poll the location of another vessel and show the position of that vessel on the display of the **GX1850/GX1800** series. Standard Horizon has taken this feature one step further, if a compatible GPS chart plotter is connected to the **GX1850/GX1800** series, the polled position of the vessel is shown on the display of the GPS chart plotter making it easy to navigate to the location of the polled vessel. This is a great feature for anyone wanting to know the position of another vessel. For example, find where your buddy is catching fish or find the location of a vessel you are cruising with.

NOTE

The other vessel must have an operating GPS receiver connected to its DSC radio, and the radio must not be set to deny position requests. (Refer the section “**11.4 INDIVIDUAL CALL**” to enter information into the individual directory).

11.6.1 Setting up a Position Request Reply

The transceiver can be set up to automatically (default setting) or manually send your position when requested by another vessel. This selection is important if you are concerned about someone polling the position of your vessel that you may not want to. In the manual mode you will see the MMSI (Maritime Mobile Service Identity Number) or persons name shown on the display allowing you to choose whether or not to send your position to the requesting vessel.

1. Press & hold  → “DSC SETUP” → “POSITION REPLY”
2. Press the [▲] or [▼] key to select “**AUTO**” or “**MANUAL**”. In “**AUTO**” mode, after a DSC POS request is received, the radio will automatically transmit your vessel’s position. In “**MANUAL**” mode, the display of the transceiver will show who is requesting the position and the [YES] soft key on the radio must be pressed to send your position to the requesting vessel.
3. Press the [ENTER] soft key to store the selected setting.
4. Press the [CLEAR] key to return to radio operation.



11.6.2 Transmitting a Position Request to Another Vessel

Position Request using the Individual/Position Directory

Refer to section “11.4 INDIVIDUAL CALL” to enter information into the individual directory.

1.  → “DSC CALL” → “POS REQUEST”
2. Press the [▲] or [▼] key to select “HISTORY” or “MEMORY”, then press the [SELECT] soft key.
3. Press the [▲] or [▼] key to select a name that is stored in the individual/position directory.
4. Press the [SELECT] soft key, then press the [YES] soft key to transmit the position request DSC call.
5. When the transceiver receives the position from the polled vessel it is shown on the radio display.
6. Press the [QUIT] soft key to return to radio operation.

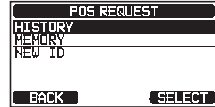

NOTE

If the transceiver does not receive position data from the polled vessel, the display will show as follows.

```
--.--.---- _  
---.--.---- _
```

Position Request by Manually Entering an MMSI

This feature allows you to request the position of a vessel by manually entering the MMSI.

1.  → “DSC CALL” → “POS REQUEST”

2. Press the [▲] or [▼] key to select “NEW ID”, then press the [SELECT] soft key.

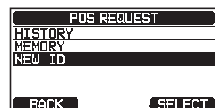

- Press the [▲]/[▼]/[◀]/[▶] keys to select the first number of the MMSI (nine digits) which you want to contact, then press the [SELECT] soft key to step to the next number.
- Repeat step 3 to set the MMSI number.
If a mistake is made entering in the MMSI number, press the [▲]/[▼]/[◀]/[▶] keys to select “←” or “→”, press the [SELECT] soft key until the incorrect character is selected, then perform step 3.
- When finished entering the MMSI number, press the [FINISH] soft key.
- Press the [YES] soft key to transmit the position request DSC call.
- When the transceiver receives the position from the polled vessel it is shown on the radio display.
- Press the [QUIT] soft key to return to radio operation.



NOTE

The received position from the polled vessel can be transferred to a GPS chart plotter via NMEA DSC and DSE sentences.

11.6.3 Receiving a Position Request

- When a position request call is received from another vessel, a ringing sound will be produced, and the display will be as shown in the illustration at the right.
- Press any key to stop the alarm.
- To send your vessel's position to the requesting vessel, press the [REPLY] soft key.
Or to exit from position request display, press the [QUIT] soft key.
- Press the [QUIT] soft key to return to the channel display.



NOTE

When there is an unread position request call, the “✉” icon will appear on the display. You may review the unread individual call from the DSC log, refer to section “11.10.3 Reviewing Other Logged Calls”.

11.7 POSITION REPORT

The feature is similar to position request, however instead of requesting a position of another vessel this function allows you to send your position to another vessel.

11.7.1 Transmitting a DSC Position Report Call

DSC Position Report Call using the Individual/Position Directory

Refer to section “11.4 INDIVIDUAL CALL” to enter information into the individual directory.

1.  → “DSC CALL” → “POS REPORT”
2. Press the [▲] or [▼] key to select “HISTORY” or “MEMORY”, then press the [SELECT] soft key.
3. Press the [▲] or [▼] key to select the name in the directory, then press the [SELECT] soft key.
4. If you want to change the position displayed, press the [POS/TM] soft key to go to the position information input screen. After inputting new position information, press the [FINISH] soft key to confirm.
5. Press the [YES] soft key to send your position to the selected vessel.
6. Press the [QUIT] soft key to return to radio operation.

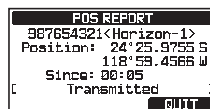
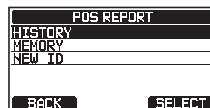

DSC Position Report Call by Manually Entering an MMSI

This feature allows you to send your position to another vessel by manually entering the MMSI of the ship you want to send your position to.

1.  → “DSC CALL” → “POS REPORT”
2. Press the [▲] or [▼] key to select “NEW ID”, then press the [SELECT] soft key.

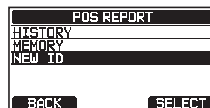

- Press the [▲] or [▼] key to select the first number of the MMSI of the vessel you want to contact, then press the [SELECT] soft key to step to the next number.
- Repeat step 3 to complete the MMSI number. If a mistake is made entering in the MMSI number, press the [▲]/[▼]/[◀]/[▶] keys to select “←” or “→”, press the [SELECT] soft key until the incorrect character is selected, then perform step 3.
- When finished entering the MMSI number, press the [FINISH] soft key.
- If you want to change the position displayed, press the [POS/TM] soft key to go to the position information input screen. After inputting the new position information, press the [FINISH] soft key to confirm.
- Press the [YES] soft key to send your position to the selected vessel.
- Press the [QUIT] soft key to return to radio operation.

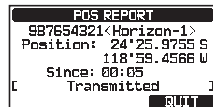
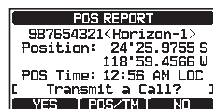

11.7.2 Receiving a DSC Position Report Call

When another operator transmits their vessels location to another **GX1850/GX1800** series receiver the following will happen:

- When a position report call is received from another vessel, a ringing sound will be produced.
- Press any key to stop ringing.
- To exit to radio mode, press the [QUIT] soft key.

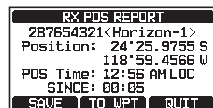
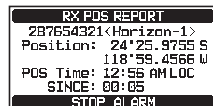

11.7.3 Navigating to the Reported Position

The transceiver has a feature that permits navigate to a received position report call by using the compass display. Navigation to the location of a position report call may be enabled by the procedure below.

- Press the [TO WPT] soft key.

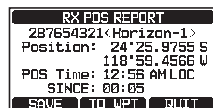

- Press the [ENTER] soft key to save the waypoint into memory.
- The display indicates the distance and direction of the received vessel, and the compass displays the received vessel with a dot (●).

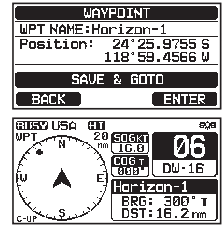

Stopping Navigation to the Reported Position

- Press one of the soft keys, then press the [STOP] soft key.
The radio will stop navigating to the waypoint and the normal VHF display will be shown.

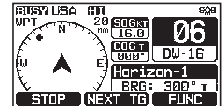

11.7.4 Saving the Reported Position as a Waypoint

The transceiver can save a position report call in the radio's memory as a waypoint.

- After the position report call has been received, press the [SAVE] soft key.
- If you want to change the name of the waypoint, press the [▲] or [▼] key to select "NAME", then press the [SELECT] soft key.
- Enter the name of the waypoint you want to reference in the directory. For details, refer to "11.4.1 Setting up the Individual / Position Call Directory".
- Press the [ENTER] soft key to save the waypoint into memory.
- Press the [OK] soft key to return to the position report display.

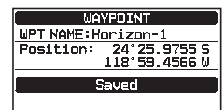
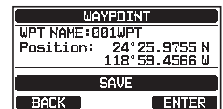
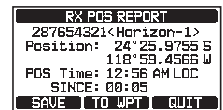

Navigating to a Saved Waypoint

Refer to section "12.1.1 Starting and Stopping Navigation" for details.

11.7.5 Setting up a Position Report Ringer

The transceiver position report ringer may be turned OFF.

1. Press & hold  \Rightarrow "DSC SETUP" \Rightarrow "DSC BEEP"
2. Press the [\blacktriangle] or [\blacktriangledown] key to select "POS REPORT", then press the [SELECT] soft key.
3. Press the [\blacktriangle] or [\blacktriangledown] key to select "OFF".
4. Press the [ENTER] soft key to store the selected setting.
5. Press the [CLEAR] key to return to radio operation.

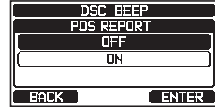

To enable the ringer tone, repeat the above procedure, press the [\blacktriangle] or [\blacktriangledown] key to select "ON" in the step 3 above.

11.8 AUTO POSITION POLLING

The transceiver has the capability to automatically track six vessels programmed into the individual directory, or to automatically send your position information to the programmed stations.

11.8.1 Setting up the Polling Operation

1. Press & hold  \Rightarrow "DSC SETUP" \Rightarrow "AUTO POSITION POLLING"
2. Press the [\blacktriangle] or [\blacktriangledown] key to select the desired operation (AUTO POS REQUEST and AUTO POS REPORT), and press the [ENTER] soft key.
3. Press the [CLEAR] key to return to radio operation.



11.8.2 Setting up the Polling Time Interval

1. Press & hold  \Rightarrow "DSC SETUP" \Rightarrow "AUTO POS INTERVAL"
2. Press the [\blacktriangle] or [\blacktriangledown] key to select the desired interval time (30 second, 1, 2, 3, and 5 minutes) and press the [ENTER] soft key.
3. Press the [CLEAR] key to return to radio operation.



11.8.3 Selecting Vessels to be Automatically Polled



NOTE

The radio uses the individual directory to select vessels to be automatically polled. Refer to section “11.4.1 Setting up the Individual / Position Call Directory” and enter the MMSI of vessels you may want to poll before proceeding.

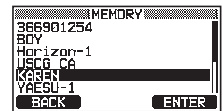
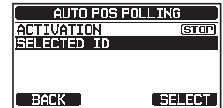
1.  → “DSC CALL” → “AUTO POS POLLING”
2. Press the [▲] or [▼] key to select “**SELECTED ID**”, then press the [SELECT] soft key.
3. The radio will show a highlighted blank row when you select the vessel for the first time. Press the [SELECT] soft key.
4. The radio will show the vessels programmed in the individual directory. Press the [▲] or [▼] key to select the desired vessel, then press the [ENTER] soft key.
5. For more entries, press the [▲] or [▼] key to select a blank row, press the [SELECT] soft key, then perform step 4.
6. When finished, press the [CLEAR] key to exit to the radio mode.



11.8.4 Enabling/Disabling Auto POS Polling

1.  → “DSC CALL” → “AUTO POS POLLING”
2. Press the [▲] or [▼] key to select “**ACTIVATION**”, then press the [SELECT] soft key.
3. Press the [▲] or [▼] key to select “**START**” to enable transmissions or “**STOP**” to disable, then press the [ENTER] soft key.
4. Press the [CLEAR] key to return to radio operation.
5. Auto POS Polling starts and the “” icon will appear on the display.

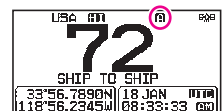
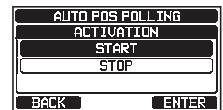
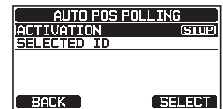

11.9 DSC TEST

This function is used to contact another DSC equipped vessel to ensure the DSC functions of the radio are operating.

NOTE

To use the DCS Test feature, a radio that is to receive the test call also needs to have the DSC Test feature.

To perform the DSC test you will need to enter the MMSI of another vessel into the individual directory or manually enter the MMSI using the procedure below.

11.9.1 Programming MMSI into Individual Directory

Refer to section “11.4.1 Setting up the Individual / Position Call Directory”.

11.9.2 Transmitting a DSC Test to Another Vessel

DSC Test call using the Individual/Position Directory

1.  → “DSC CALL” → “DSC TEST CALL”
2. Press the [▲] or [▼] key to select “HISTORY” or “MEMORY”, then press the [SELECT] soft key.
3. Press the [▲] or [▼] key to select the ship name, then press the [SELECT] soft key.
4. Press the [YES] soft key to transmit the DSC test call to the other vessel.
5. Press the [QUIT] soft key to return to radio operation.

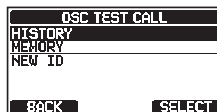

DSC Test Call by Manually Entering an MMSI

1.  → “DSC CALL” → “DSC TEST CALL” → “MANUAL”

2. Press the [▲] or [▼] key to select “NEW ID”, then press the [SELECT] soft key.

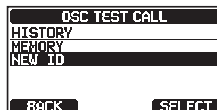

- Press the [▲] or [▼] key to select the first digit in the MMSI, then press the [SELECT] soft key.
 - Repeat step 3 until all the numbers of the MMSI are shown on the display.
 - Press the [FINISH] soft key to show the test call page.
 - Press the [YES] soft key to transmit the DSC test call to the other vessel.
- Press the [QUIT] soft key to return to radio operation.



NOTE

When the radio receives a test call reply from the vessel that was called, the radio will ring and show “**RX TEST CALL**” on the display, this confirms the called radio has received the test call.

11.9.3 Receiving a DSC Test Call

When another vessel transmits a DSC Test call to the **GX1850/GX1800** series following will happen:

- When a DSC Test call is received, the radio will automatically respond to the calling vessel.
- To exit from the DSC Test call display, press the [QUIT] soft key.



11.10 DSC LOG OPERATION

The **GX1850/GX1800** series logs transmitted calls, received DSC distress calls, and other calls (individual, group, all ships, etc.). The DSC log feature is similar to an answer machine where calls are recorded for review and an “☑” icon will appear on the radio's display. The **GX1850/GX1800** series can store up to 100 transmitted calls, up to the latest 50 distress calls, and up to the latest 100 other calls (individual, group, all ships, position report, position request acknowledge and test call acknowledge).

NOTE

When the “**DSC LOG**” menu is selected, the transceiver series may display high-priority logged calls automatically.

11.10.1 Reviewing and Resending a Transmitted Logged Call

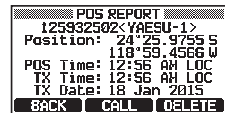
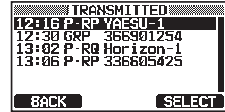
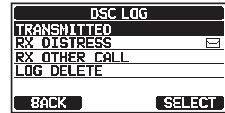

The transceiver allows transmitted logged calls to be reviewed and resent.

1.  → “DSC CALL” → “DSC LOG”
2. Press the [▲] or [▼] key to select “TRANSMITTED”, then press the [SELECT] soft key.
3. Press the [▲] or [▼] key to select the station (name or MMSI number) you want to review and/or resend the call.
4. Press the [SELECT] soft key to review details of the selected station.
5. Press the [CALL] soft key to resend the DSC call or press the [BACK] soft key to go back to the transmitted DSC call list.



11.10.2 Reviewing a Logged DSC RX Distress Alert and acknowledgement

The transceiver allows logged DSC RX distress alerts and acknowledgements to be reviewed.

1.  → “DSC CALL” → “DSC LOG” → “RX DISTRESS”
2. Press the [▲] or [▼] key to select the station (name or MMSI number) of the distress alert you want to review its acknowledgement.
NOTE: When there is an unread received call, the  icon will appear to the left of the logged call.
3. Press the [SELECT] soft key to review details for the selected station.
4. Press the [INFO] soft key to display more information or press the [BACK] soft key to go back to the received DSC distress call list.

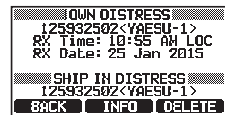
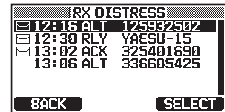

11.10.3 Reviewing Other Logged Calls

1.  → “DSC CALL” → “DSC LOG” → “RX OTHER CALL”
2. Press the [▲] or [▼] key to select the station (name or MMSI number) you want to review and/or call back.



NOTE: When received call is unread, the “” icon will appear to the left of the logged call.

3. Press the [**SELECT**] soft key to review details of the selected station.
4. Press the [**REPLY**] soft key to reply to the call or press the [**BACK**] soft key to return to the received call list.

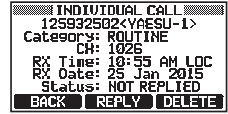

11.10.4 Deleting Logged Calls from the DSC Log Directory

1.  ⇒ “DSC CALL” ⇒ “DSC LOG” ⇒ “LOG DELETE”

2. Press the [**▲**] or [**▼**] key to select the category (“TRANSMITTED”, “RX DISTRESS”, “RX OTHER CALL” or “ALL LOG”) to be deleted.



3. Press the [**SELECT**] soft key.

The display will show “Do you want to delete the LOG?”.

4. Press the [**YES**] soft key. (To cancel, press the [**NO**] soft key.)



5. Press the [**CLEAR**] key to return to radio operation.

NOTE

The procedure above will delete all logged calls of the selected category at one time.

To delete logged calls one by one, review the details of the call you want to delete, then press the [**DELETE**] soft key.

11.11 DSC LOOP BACK OPERATION

The **GX1850/GX1800** series has a DSC self-test feature.

1.  ⇒ “DSC CALL” ⇒ “DSC LOOP BACK”

2. Press the [**YES**] soft key to start a test. (To cancel, press the [**NO**] soft key.)



The display will show “Passed!” if the DSC feature properly operates. Press the [**OK**] soft key to return to the “DSC CALL” menu.

3. Press the [**CLEAR**] key to return to radio operation.

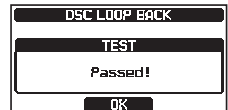

12 NAVIGATION

The **GX1850/GX1800** series is capable of storing up to 250 waypoints for navigation using the compass page.

You can also navigate to a DSC distress call with location data, or to the position received from another DSC radio using DSC polling.

12.1 WAYPOINT OPERATION

12.1.1 Starting and Stopping Navigation

Navigation Using the Waypoint Directory

1.  → "NAVI" → "WAYPOINT"

2. Press the [▲] or [▼] key to select the desired category ("HISTORY" or "MEMORY"), then press the [SELECT] soft key.

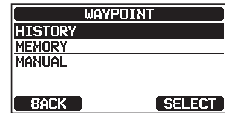

3. Press the [▲] or [▼] key to select a waypoint, then press the [SELECT] soft key. The navigation screen will appear.



The navigation screen includes the distance and direction to the destination. The destination waypoint is indicated by a dot (●) inside the compass.

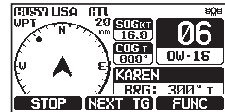

4. Press one of the soft keys, then press the [STOP] soft key to exit the navigation screen.

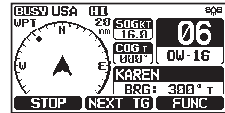

Navigation by Manually Entering a Waypoint

1.  → "NAVI" → "WAYPOINT"

2. Press the [▲] or [▼] key to select "MANUAL", then press the [SELECT] soft key.

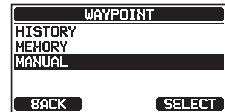

3. If you want to give the waypoint an easy-to-find name, press the [▲] or [▼] key to select "NAME:", press the [SELECT] soft key, then enter the name. For details, refer to "11.4.1 Setting up the Individual / Position Call Directory".

4. Press the [▲] or [▼] key to select "POSITION:", then press the [SELECT] soft key.

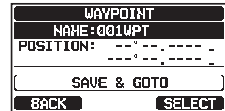

- Press the [▲] or [▼] key to select the first number of latitude, then press the [SELECT] soft key to step to the next number.
- Repeat step 5 to set the position.
If a mistake is made, press the [▲]/[▼]/[◀]/[▶] keys to select “←” or “→”, press the [SELECT] soft key until the incorrect character is selected, then perform step 5.
- When finished programming the position, press the [FINISH] soft key. The display will return to the previous screen.
- Press the [▲] or [▼] key to select “SAVE & GOTO”, then press the [SELECT] soft key. The navigation screen will appear.



The screen includes the distance and direction to the destination. The destination and the waypoint is indicated by a dot (●) inside the compass.

- Press one of the soft keys, then press the [STOP] soft key to exit the navigation screen.

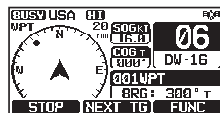
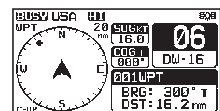

12.1.2 Setting Up Waypoint Directory

Marking a Position



This feature allows the radio to mark the current position of the vessel.

- Press & hold  "WAYPOINT SETUP" → "MARK POSITION"

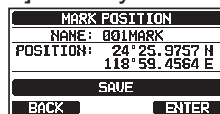
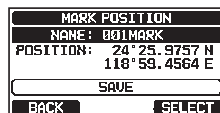
- If you want to modify the name, Press the [▲] or [▼] key to select “NAME:”, then press the [SELECT] soft key.
- Enter the waypoint name by pressing the [▲] or [▼] key and the [SELECT] soft key.
When finished entering the name (using 11 characters or less), press the [FINISH] soft key.
- If you want to modify the position, press the [▲] or [▼] key to select “POSITION:”, press the [SELECT] soft key, then enter the new coordinates.
When finished modifying the position, press the [FINISH] soft key.
- Press the [▲] or [▼] key to select “SAVE”, then press the [SELECT] soft key to save the mark position into memory.
- Press the [CLEAR] key to return to radio operation.



Adding a Waypoint

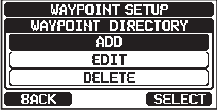

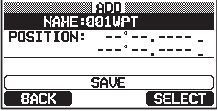
1. Press & hold  **“WAYPOINT SETUP”**  **“WAYPOINT DIRECTORY”**
2. Press the **[▲]** or **[▼]** key to select **“ADD”**, then press the **[SELECT]** soft key.

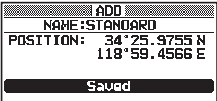
```
WAYPOINT SETUP
WAYPOINT DIRECTORY
ADD
EDIT
DELETE
BACK SELECT
```
3. Press the **[▲]** or **[▼]** key to select **“NAME:”**, then press the **[SELECT]** soft key.
4. Enter the waypoint name by pressing the **[▲]/[▼]/[◀]/[▶]** keys and the **[SELECT]** soft key.
When finished entering the name (using 11 characters or less), press the **[FINISH]** soft key.

```
ADD
NAME:001UPT
POSITION:  : : : : : : : : : :
BACK SAVE SELECT
```
5. Press the **[▲]** or **[▼]** key to select **“POSITION:”**, press the **[SELECT]** soft key, then enter the waypoint coordinates.
When finished entering the position, press the **[FINISH]** soft key.
6. Press the **[▲]** or **[▼]** key to select **“SAVE”**, then press the **[SELECT]** soft key to save the waypoint into memory.
7. Press the **[CLEAR]** key to return to radio operation.

```
ADD
NAME:STANDARD
POSITION: 34°25.9755 N
          118°59.4566 E
Saved
```

Editing a Waypoint

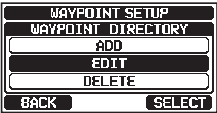
1. Press & hold  **“WAYPOINT SETUP”**  **“WAYPOINT DIRECTORY”**
2. Press the **[▲]** or **[▼]** key to select **“EDIT”**, then press the **[SELECT]** soft key.

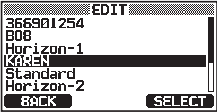

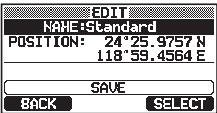

```
WAYPOINT SETUP
WAYPOINT DIRECTORY
ADD
EDIT
DELETE
BACK SELECT
```
3. Press the **[▲]** or **[▼]** key to select the waypoint to be edited, then press the **[SELECT]** soft key to show the waypoint input display.
4. Press the **[▲]** or **[▼]** key to select **“NAME:”** or **“POSITION:”**, then press the **[SELECT]** soft key.
5. Press the **[▲]/[▼]/[◀]/[▶]** keys to select **“←”** or **“→”**, press the **[SELECT]** soft key until the character to be changed is selected, then enter a new character.
6. Repeat step 5 until the waypoint is updated.
When finished editing, press the **[FINISH]** soft key.
7. Press the **[▲]** or **[▼]** key to select **“SAVE”**, then press the **[SELECT]** soft key to store the edited waypoint into memory.

```
EDIT
366901254
BOB
Horizon-1
KAREN
Standard
Horizon-2
BACK SELECT
```



```
EDIT
NAME:Standard
POSITION: 24°25.9757 N
          118°59.4564 E
SAVE
BACK SELECT
```
8. Press the **[CLEAR]** key to return to radio operation.

Deleting a Waypoint

1. Press & hold  ►►► “WAYPOINT SETUP” ►►► “WAYPOINT DIRECTORY”
2. Press the [▲] or [▼] key to select “DELETE”, then press the [SELECT] soft key.
3. Press the [▲] or [▼] key to select the waypoint to be deleted, then press the [SELECT] soft key.
4. Confirm the waypoint to be deleted, press the [▲] or [▼] key to select “OK”, then press the [SELECT] soft key.
5. Press the [CLEAR] key to return to radio operation.

Saving a DSC Position Call as a Waypoint

When a position is received from another DSC radio the **GX1850/GX1800** series allows the position to be saved as a waypoint.

Refer to section “**11.7.4 Saving the Reported Position as a Waypoint**” for details.

12.1.3 Selecting the Display Range

This menu item allows setting of the range on the compass display.

1. Press & hold  ►►► “WAYPOINT SETUP” ►►► “DISPLAY RANGE”
2. Press the [▲] or [▼] key to select desired range. (Unit of measure depends on the settings in the GPS SETUP menu. Refer to section “**18.7 UNITS OF MEASURE**”.)
3. Press the [ENTER] soft key to store the selected setting.
4. Press the [CLEAR] key to return to radio operation.

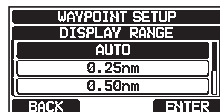

12.1.4 Selecting the Arrival Range

This menu setting determines the arrival range distance. An alert will sound when your vessel navigates to within the arrival range of the designated waypoint.

1. Press & hold  ►►► “WAYPOINT SETUP” ►►► “ARRIVAL RANGE”
2. Press the [▲] or [▼] key to select desired range. (Unit of measure depends on the settings in the GPS SETUP menu. Refer to section “**18.7 UNITS OF MEASURE**”.)
3. Press the [ENTER] soft key to store the selected setting.
4. Press the [CLEAR] key to return to radio operation.

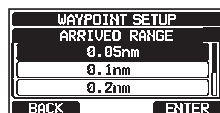

12.2 ROUTING OPERATION

The **GX1850/GX1800** series permits setting 1 to 30 waypoints along the route to a destination.

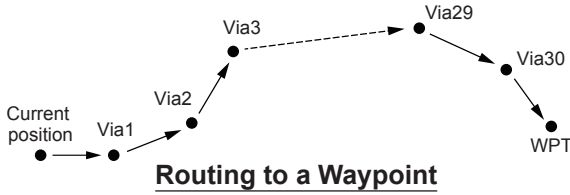





12.2.1 Setting Up Routing Directory

NOTE

All the destinations and via-points must be programmed as waypoints in the memory. Refer to section “12.1.2 Setting Up Waypoint Directory”.

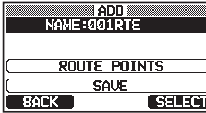
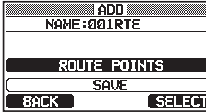
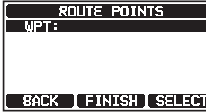
Adding a Route

- Press & hold  → “WAYPOINT SETUP” → “ROUTE DIRECTORY”
- Press the [▲] or [▼] key to select “ADD”, then press the [SELECT] soft key.
 
- Press the [▲] or [▼] key to select “NAME:”, then press the [SELECT] soft key.
 
- Enter the route name by pressing the [▲] or [▼] key and the [SELECT] soft key.
When finished entering the name (using 11 characters or less), press the [FINISH] soft key.
- Press the [▲] or [▼] key to select “ROUTE POINTS”, press the [SELECT] soft key.
 
- Press the [▲] or [▼] key to select “WPT:”, then press the [SELECT] soft key.
- Press the [▲] or [▼] key to select a waypoint, then press the [SELECT] soft key.
- Press the [▲] or [▼] key to select “Via 1:”, then press the [SELECT] soft key.
 



9. Press the [▲] or [▼] key to select a waypoint, then press the [SELECT] soft key.
10. Repeat steps 8 and 9 to add more via-points.
11. Press the [BACK] soft key.
12. Press the [▲] or [▼] key to select “SAVE”, then press the [ENTER] soft key to store the route into memory.
13. Press the [CLEAR] key to return to radio operation.

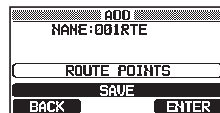

Editing a Route

This function allows a previously entered route to be edited.

1. Press & hold [MENU/SET] → “WAYPOINT SETUP” → “ROUTE DIRECTORY”

2. Press the [▲] or [▼] key to select “EDIT”, then press the [SELECT] soft key.

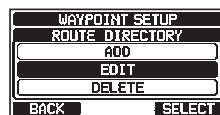

3. Press the [▲] or [▼] key to select the route to be edited, then press the [SELECT] soft key to show the route input display.

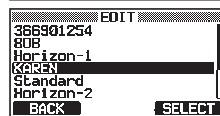

4. Perform steps 3 to 11 of the previous page until the route is updated.

5. Press the [▲] or [▼] key to select “SAVE”, then press the [SELECT] soft key to store the edited route into memory.

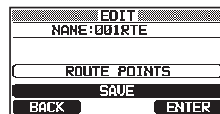

6. Press the [CLEAR] key to return to radio operation.

Deleting a Route

1. Press & hold [MENU/SET] → “WAYPOINT SETUP” → “ROUTE DIRECTORY”

2. Press the [▲] or [▼] key to select “DELETE”, then press the [SELECT] soft key.

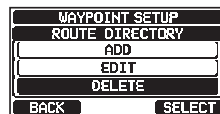

3. Press the [▲] or [▼] key to select the route to be deleted, then press the [SELECT] soft key.



4. Confirm the route to be deleted, press the [▲] or [▼] key to select “OK”, then press the [SELECT] soft key.

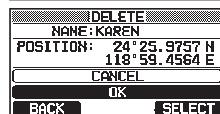

5. Press the [CLEAR] key to return to radio operation.

12.2.2 Starting and Stopping Route Navigation

1.  → “NAVI” → “ROUTE”
2. Press the [▲] or [▼] key to select the desired category (“HISTORY” or “MEMORY”), then press the [SELECT] soft key.
3. Press the [▲] or [▼] key to select a route, then press the [SELECT] soft key. The navigation screen with “RUT” indicator appears.
4. A message “ARRIVED” will appear when the first target point is reached.
To start navigation to the next target, press the [YES] soft key.
5. Press one of the soft keys, then press the [STOP] soft key to exit the navigation screen.

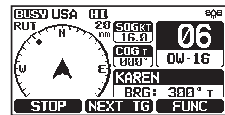
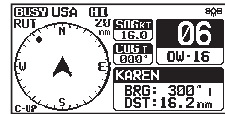
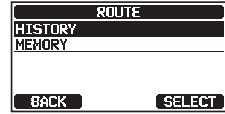

12.2.3 Changing the Destination

1. On the navigation screen, press one of the soft keys, then press the [NEXT TG] soft key.
2. Press the [▲] or [▼] key to select the desired destination, then press the [SELECT] soft key.
3. The navigation screen with the new destination appears.

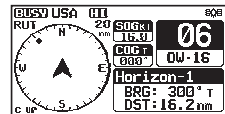
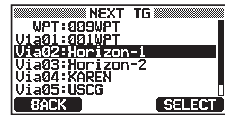
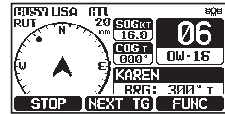

12.2.4 Selecting Automatic or Manual Routing

When your vessel arrives at a via waypoint, this setting determines whether or not navigation to the next waypoint will continue automatically or must be initiated manually.

1. Press & hold  → “WAYPOINT SETUP” → “ROUTING OPERATION”
2. Press the [▲] or [▼] key to select “AUTO” or “MANUAL”, then press the [ENTER] soft key.
3. Press the [CLEAR] key to return to radio operation.

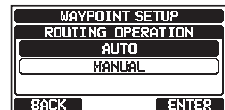

13 GM OPERATION

The GM (Group Monitor) feature of the **GX1850/GX1800** series utilizes the same system as the DSC Group call and Auto Position Polling, to display the group members' locations.

13.1 SETTING UP GM OPERATION

The transceiver is capable of storing up to 10 groups with 1 to 9 members each.

13.1.1 Setting Up GM Group Directory

NOTE

- For this function to operate, the same group MMSI must be programmed into the transceivers of all the group members to be monitored. Refer to section “**11.5.1 Setting up a Group Call**” for details.
- Group members for GM operation can only be selected from the Individual/Position Call directory, therefore for all members that you want to monitor, must be stored in the directory. Refer to section “**11.4.1 Setting up the Individual / Position Call Directory**” for details.

1. Press & hold [MENU/SET] → “GM SETUP” → “GM GROUP DIRECTORY”

2. Press the [▲] or [▼] key to select “ADD”, then press the [SELECT] soft key.



3. Press the [▲] or [▼] key to select “NAME:”, then press the [SELECT] soft key.

4. Enter the route name by pressing the [▲] or [▼] key and the [SELECT] soft key.



When finished entering the name (using 11 characters or less), press the [FINISH] soft key.

5. Press the [▲] or [▼] key to select “GM ID:”, press the [SELECT] soft key, then enter the group MMSI number.



When finished entering the MMSI, press the [FINISH] soft key.

6. Press the [▲] or [▼] key to select “MEMBER”, then press the [SELECT] soft key.



7. Press the [▲] or [▼] key to select a directory list number, then press the [SELECT] soft key.
8. Press the [▲] or [▼] key to select a member from the Individual directory, then press the [SELECT] soft key.
9. Repeat steps 8 to add members to the group, then press the [BACK] soft key.
10. Press the [BACK] soft key to return to the “NAME:” and “GM ID:” screen.
11. Press the [▲] or [▼] key to select “SAVE” to store the data, then press the [ENTER] soft key.
12. To enter another group directory, repeat steps 2 through 11.
13. Press the [CLEAR] key to return to radio operation.

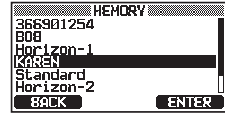

13.1.2 Setting Up the Polling Time Interval

1. Press & hold  "GM SETUP" ➡ "INTERVAL"
2. Press the [▲] or [▼] key to select the desired polling interval time, then press the [ENTER] soft key.
3. Press the [CLEAR] key to return to radio operation.



13.1.3 Enabling/Disabling Transmission during GM Operation

1. Press & hold  "GM SETUP" ➡ "GM TX"

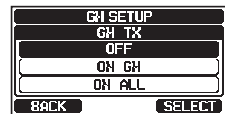

2. Press the [▲] or [▼] key to select the desired transmission type, then press the [ENTER] soft key.
 - OFF: Disables the transmission during GM operation.
 - ON GM: Enables the transmission during the GM target display.
 - ON ALL: Enables the transmission during the GM operation.
3. Press the [CLEAR] key to return to radio operation.

13.2 STARTING GM OPERATION

NOTE

To start GM operation, configure the GM Group Directory setting in setup menu. Otherwise, you cannot start the GM operation. Refer to section “13.1.1 Setting Up GM Group Directory” for details.

1.  → “GM”
2. Press the [▲] or [▼] key to select a group you want to monitor, then press the [SELECT] soft key.

The GM operation begins, and the GM target display appears.

3. Press the [CLEAR] key to return to radio operation.

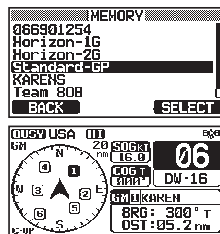

13.2.1 Changing the GM Group Being Monitored

1. On the GM target display, press one of the soft keys, then press the [TG LIST] soft key.
2. Press the [CHG GRP] soft key.
3. Press the [▲] or [▼] key to select the name of the group you want to monitor, then press the [SELECT] soft key.

The GM group being monitored changes. The GM target display appears.

4. Press the [CLEAR] key to return to radio operation.

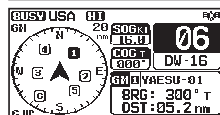
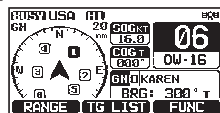

13.2.2 Transmitting a DSC Call to a Group Member

1. On the GM target display, press one of the soft keys, then press the [TG LIST] soft key.

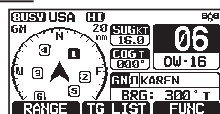

2. Press the [▲] or [▼] key to select a member you want to call.
3. Press the [SELECT] soft key to display the location, distance, and bearing of the selected member.
4. Press the [CALL] soft key to transmit a DSC Individual call to the selected member.

GM-GRP Standard-GRP	
NAME	DST NM
1:KAREN	20.5
2:80B	05.2
3:Horizon-1	12.8
4:Standard-2	34.9
[BACK] [CHG GRP] [SELECT]	

GM-GRP Standard-GRP	
KAREN	
Position: 24°25.9755 S	
118°59.4566 W	
DST:	11 NM
BRG:	120°T
[BACK] [CALL] [TO WPT]	

13.2.3 Starting Navigation to a Group Member

1. On the GM target display, press one of the soft keys to show the key selections.
2. Press the [TG LIST] soft key.
3. Press the [▲] or [▼] key to select a member you want to approach.
4. Press the [SELECT] soft key to display the location, distance, and bearing of the selected member.
5. Press the [TO WPT] soft key to start navigation to the selected member. (Press the [BACK] soft key twice to cancel and return to the GM target display.)

GM-GRP Standard-GRP	
KAREN	
Position: 24°25.9755 S	
118°59.4566 W	
DST:	11 NM
BRG:	120°T
[BACK] [CALL] [TO WPT]	

GM-GRP Standard-GRP	
NAME	DST NM
1:KAREN	20.5
2:80B	05.2
3:Horizon-1	12.8
4:Standard-2	34.9
[BACK] [CHG GRP] [SELECT]	

GM-GRP Standard-GRP	
KAREN	
Position: 24°25.9755 S	
118°59.4566 W	
DST:	11 NM
BRG:	120°T
[BACK] [CALL] [TO WPT]	

14 NMEA 2000 SETUP (GX1850 series only)

Set the device numbers and system numbers of devices connected to the NMEA 2000 network.

14.1 SELECT DEVICE

Select the device for which you want to set the device number and system number.

1. Press & hold  → “NMEA2000 SETUP” → “SELECT DEVICE”
2. In the SELECT DEVICE list, press the [▲] or [▼] key to select the external device for which the device number and the system number are to be set.
3. Press the [SELECT] soft key to store the selected setting.
4. Press the [CLEAR] key to return to radio operation.

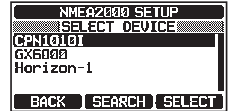

NOTE

If any devices connected to the network are not displayed in the list, press the [SEARCH] soft key to update the list.

14.2 DEVICE NUMBER

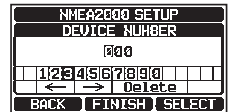

If connecting two or more the **GX1850** series, change the device number of either one. Set the device number of the device selected in “14.1 SELECT DEVICE”.

1. Press & hold  → “NMEA2000 SETUP” → “DEVICE NUMBER”
2. Press the [▲] or [▼] key to select the first digit of the device number, then press the [SELECT] soft key to step to the next number.
3. Repeat step 2 to set the device number within the range of 000 to 251. (“000” is default).
4. If a mistake is made entering in the device number, press the [▲]/[▼]/[◀]/[▶] keys to select “←” or “→”, press the [SELECT] soft key until the incorrect character is selected, and perform step 2.
5. When finished programming the device number, press the [FINISH] soft key.
6. Press the [CLEAR] key to return to radio operation.



14.3 SYSTEM NUMBER

Set the system number of the device selected in “14.1 SELECT DEVICE”.

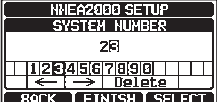
- Press & hold  → “NMEA2000 SETUP” → “SYSTEM NUMBER”
- Press the [◀] or [▶] key to select the first digit of the system number, then press the [SELECT] soft key to step to the next number. 
- Repeat step 2 to set the system number within the range of 00 to 15. (“00” is default).
- If a mistake is made entering in the system number, press the [▲]/[▼]/[◀]/[▶] keys to select “←” or “→”, press the [SELECT] soft key until the incorrect character is selected, then perform step 2.
- When finished programming the system number, press the [FINISH] soft key. 
- Press the [CLEAR] key to return to radio operation.

14.4 SUMMARY OF THE NMEA 2000 SETUP

Item	Description	Default Value	Page
SELECT DEVICE	Select the device for which you want to set the device number or the system number	-	79
DEVICE NUMBER	Set the device number	000	79
SYSTEM NUMBER	Set the system number	00	80

14.5 COMPATIBLE NMEA 2000 PGN LIST

Receive		Transmit	
059392	ISO Acknowledgement	059392	ISO Acknowledgement
059904	ISO Request	059904	ISO Request
060928	ISO Address Claim	060928	ISO Address Claim
065240	ISO Commanded Address	-	-
126464	Receive/Transmit PGN's group function	126464	Receive/Transmit PGN's group function
126993	Heartbeat	126993	Heartbeat
126996	Product Information	126996	Product Information
127237	Heading/Track Control	-	-
127250	Vessel Heading	-	-
127258	Magnetic Variation	-	-
128259	Speed	-	-
129025	Position, Rapid Update	-	-
129026	COG and SOG, Rapid Update	-	-
129029	GNSS Position Data	129029	GNSS Position Data
129033	Local Time Offset	-	-
-	-	129799	Radio Frequency/Mode/Power
-	-	129808	DSC Call Information
129540	GNSS Sats in View	129540	GNSS Sats in View

15 CONFIGURATION SETUP

15.1 DISPLAY MODE

The display mode can be selected according to the time of day you operate the radio.

1. Press & hold  ⇒ **“CONFIGURATION”** ⇒ **“DISPLAY MODE”**
2. Press the [▲] or [▼] key to select the desired setting. Select the **“DAY MODE”** or **“NIGHT MODE”** setting.
DAY MODE: Normal display mode.
NIGHT MODE: Low brightness display mode for night use.
3. Press the [ENTER] soft key to store the selected setting.
4. Press the [CLEAR] key to return to radio operation.

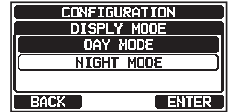

15.2 DIMMER ADJUSTMENT

This menu selection adjusts the backlight intensity.

1. Press & hold  ⇒ **“CONFIGURATION”** ⇒ **“DIMMER”**
2. Press the [▲] or [▼] key to select the desired level (“7” is default). When “OFF” is selected, the lamp is turned OFF.
3. Press the [ENTER] soft key to store the selected level.
4. Press the [CLEAR] key to return to radio operation.

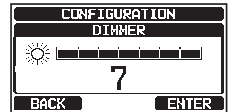

15.3 DISPLAY CONTRAST

The display contrast can be adjusted to suit your operation environment.

1. Press & hold  ⇒ **“CONFIGURATION”** ⇒ **“CONTRAST”**
2. Press the [▲] or [▼] key to select the desired level. The contrast level can be set from “1” to “30” (“15” is default).
3. Press the [ENTER] soft key to store the selected level.
4. Press the [CLEAR] key to return to radio operation.

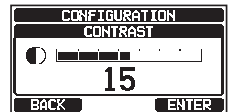

15.4 KEY BEEP

This selection is used to select the beep tone volume level when a key is pressed.

1. Press & hold  ⇒ **“CONFIGURATION”** ⇒ **“KEY BEEP”**
2. Press the [▲] or [▼] key to select the desired level. The beep level can be set from “1” to “7”, or “OFF” (“7” is default).
3. Press the [ENTER] soft key to store the selected level.
4. Press the [CLEAR] key to return to radio operation.

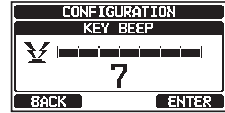









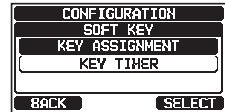





15.5 SOFT KEYS

From this menu, you can assign desired functions to each soft key from numbers 01 to 12. You can also set how long the soft key icon will be displayed after the corresponding soft key is pressed.

15.5.1 Key Assignment

1. Press & hold  ⇒ **“CONFIGURATION”** ⇒ **“SOFT KEY”**
2. Press the [▲] or [▼] key to select **“KEY ASSIGNMENT”**, then press the [SELECT] soft key.
3. Press the [▲] or [▼] key to select the key number to be programmed, and press the [SELECT] soft key.
4. Press the [▲] or [▼] key to select a new function to be assigned, and press the [ENTER] soft key. Available functions are listed below. By selecting “NONE” the soft key assignment is removed.
5. Repeat steps 3 and 4 to program other soft keys. The VHF radio functions can be assigned to a maximum of 12 soft keys.
6. Press the [CLEAR] key to return to radio operation.



DISPLAY	SOFT KEY ICON	FUNCTION	SOFT KEY NUMBERS ASSIGNED AS DEFAULT (See the previous page.)
NONE	-	-	-
WX/CH		Switches channels between weather and marine	01 (GX1850GPS, GX1850, GX1800GPS, GX1800)
SCAN		Turns the scanning function ON or OFF	05
SCAN MEMORY		Add or remove channels from memory channel scan	04
MULTI WATCH		Starts and stops dual watch or triple watch scan	06
PRESET		Programs or deletes the preset memory channel	10 (GX1850GPS, GX1850, GX1800GPS, GX1800) 01 (GX1850GPS/E, GX1800GPS/E)
INTERCOM		Activates intercom between radio and optional RAM4 mic (SSM-70H)	10
MARK POSITION		Marks the current position for a "Waypoint"	07
NAVIGATION		Enables the "Waypoint" or "Route" navigation display	08
COMPASS		Enables the "Compass" display	09
TX HI/LO		Selects transmit power	02
MAN OVERBOARD		Marks the position where a person falls overboard	03
CH NAME		Edit channel names	10 (GX1850GPS/E, GX1800GPS/E)
DISPLAY MODE		Switches the display between daytime and nighttime mode	12

15.5.2 Key Timer

- Press & hold  ⇒ "CONFIGURATION" ⇒ "SOFT KEY"
- Press the [▲] or [▼] key to select "KEY TIMER", then press the [SELECT] soft key.
- Press the [▲] or [▼] key to select the desired time, default is 5 seconds.
- Press the [ENTER] soft key to store the selected setting.
- Press the [CLEAR] key to return to radio operation.

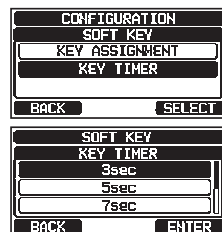

15.6 RESET

The memory and the setup categories may be reset independently, or the transceiver may be reset to the original factory settings.

1. Press & hold  "CONFIGURATION"  "RESET"

2. Press the [**▲**] or [**▼**] key to select the desired category from: "DSC/GM SETUP", "WAYPOINT SETUP", "CHANNEL SETUP", "GPS SETUP", "CONFIGURATION", "FACTORY" (all settings*¹ except the "MMSI" and "ATIS"*² will be initialized), "USER MMSI", or "ATIS CODE"*².



*¹(The Individual Directory is also cleared.)

*²(GX1850GPS/E and GX1800GPS/E only)

For details on resetting "USER MMSI" and "ATIS CODE", refer to "15.6.1 Reset the USER MMSI and ATIS CODE".

3. Press the [**SELECT**] soft key.
4. Press the [**YES**] soft key. (To cancel, press the [**NO**] soft key.)
5. Press the [**OK**] soft key.
6. Press the [**CLEAR**] key to return to radio operation.



15.6.1 Reset the USER MMSI and ATIS CODE

If the MMSI number and ATIS* code need to be reset. Please contact Standard Horizon to obtain the required reset codes.

*(GX1850GPS/E and GX1800GPS/E only)

To request the Reset Code

Contact Standard Horizon and confirm the following required information.

•The Information Necessary to obtain the Reset Code:

- Model name
- Serial number
- Current MMSI number and/or ATIS code
(To check the MMSI number and ATIS code, refer to "8.6.1 Maritime Mobile Service Identity (MMSI)" or "19 ATIS SETUP (GX1850GPS/E and GX1800GPS/E only)".)
- Request codes for the MMSI number and/or the ATIS code
(See "Checking the Request code" below).

●Contact Information

USA/Canada

E-mail: marinetech@yaesu.com

Telephone: (800) 767-2450

Europe

E-mail: service@yaesu.co.uk

Telephone: +44 (0)1962 866667

Checking the Request code

1. Press & hold  ⇒ **“CONFIGURATION”** ⇒ **“RESET”**
2. Press the [▲] or [▼] key to select the desired category. You can select either **“USER MMSI”**, or **“ATIS CODE”***, then press the [SELECT] soft key.
*(GX1850GPS/E and GX1800GPS/E only)
3. Press the [SELECT] soft key again.
The request code will be displayed.

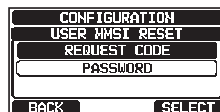
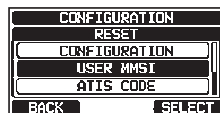

NOTE

When resetting both **“USER MMSI”** and **“ATIS CODE”**, both request codes are required.

Resetting the USER MMSI and ATIS codes

Here is the procedure for resetting the USER MMSI and ATIS codes after obtaining the reset codes.

1. The RESET screen is displayed on step 2 in **“Checking the Request code”**.
2. Press the [▲] or [▼] key to select **“PASSWORD”**, then press the [SELECT] soft key.
The password input screen will appear.
3. Press the [▲]/[▼]/[◀]/[▶] keys to select the first digit of the reset password, then press the [SELECT] soft key to step to the next number.

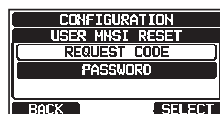

4. Repeat steps 3 until the reset password is complete. If a mistake is made entering in the station name, press the [▲]/[▼]/[◀]/[▶] keys to select “←” or “→”, press the [SELECT] soft key until the incorrect character is selected, then perform step 3.

5. Press the [FINISH] soft key. If the reset is successful, “Completed!” will appear on the screen.



If the error message is displayed, input the reset code again.

6. Press the [OK] soft key to return to the setup screen.

NOTE

The acquired reset password is available only one time.

15.7 SUMMARY OF THE CONFIGURATION SETUP

Item	Description	Default Value	Page
DISPLAY MODE	Toggles LCD display mode between daytime and nighttime mode	DAY MODE	81
DIMMER	Adjusts the backlight level of the LCD and keypad	7	81
CONTRAST	Adjusts the contrast of the LCD	15	81
KEY BEEP	Adjusts the volume of beep tone when a key is pressed	7	82
SOFT KEY	Sets the assignment and display time of the soft keys	10 sec	82
SOFT KEY			
KEY ASSIGNMENT	Sets the assignment of the soft keys	-	82
KEY TIMER	Sets the display time of the soft keys	5 sec	83
RESET	Initializes the memories and settings	-	84

16 CHANNEL FUNCTION SETUP

16.1 CHANNEL GROUP

This menu item allows you to selection of a channel group from USA, Canada*, and International. Refer to section “9.7 CHANNEL GROUP” for details.

16.2 WEATHER ALERT (USA version only)

Enables/disables the NOAA Weather Alert function. The default setting is “ON”.

1. Press & hold  ⇒ “CHANNEL SETUP” ⇒ “WX ALERT”

2. Press the [▲] or [▼] key to select “ON” or “OFF”.
3. Press the [ENTER] soft key to store the selected setting.
4. Press the [CLEAR] key to return to radio operation.



16.3 SCAN MEMORY

To be able to scan channels the scan memory must be programmed. This section designates channels to be stored into scan memory. Refer to section “9.10.2 Programming Scan Memory” for details.

16.4 SCAN TYPE

This selection is used to select the scan mode between “MEMORY” and “PRIORITY”. The default setting is “PRIORITY”. Refer to section “9.10.1 Selecting Scan Type” for details.

16.5 SCAN RESUME

This selection is used to set the time after a transmission ends before the radio starts to scan channels again. The default setting is 3 seconds.

1. Press & hold  ⇒ “CHANNEL SETUP” ⇒ “SCAN RESUME”

2. Press the [▲] or [▼] key to select the desired resume time, default is 3 seconds. The resume time can be set to “1sec” through “5sec”.
3. Press the [ENTER] soft key to store the new setting.
4. Press the [CLEAR] key to return to radio operation.



16.6 MULTI WATCH

This selection is used to select the watch type between “DUAL” and “TRIPLE”. The default setting is “DUAL”. Refer to section “9.9 MULTI WATCH (TO PRIORITY CHANNEL)” for details.

16.7 PRIORITY CHANNEL

This procedure permits setting a different priority channel to be used when priority scanning. By default, the priority channel is set to Channel 16.

1. Press & hold  ⇒ “CHANNEL SETUP” ⇒ “PRIORITY CHANNEL”

2. Press the [▲] or [▼] key to select the desired channel to be a priority.
3. Press the [ENTER] soft key to store the new setting.
4. Press the [CLEAR] key to return to radio operation.

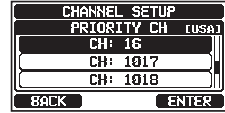

16.8 SUB CHANNEL

By default, the sub channel is set to Channel 9. This procedure permits assigning a different sub channel for instant access.

1. Press & hold  ⇒ “CHANNEL SETUP” ⇒ “SUB CHANNEL”

2. Press the [▲] or [▼] key to select the desired channel to be a sub channel.
3. Press the [ENTER] soft key to store the new setting.
4. Press the [CLEAR] key to return to radio operation.

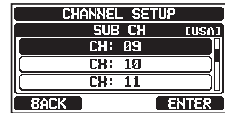

16.9 CHANNEL NAME

When the radio (“Normal”) mode is selected, the display will show a name under the channel number. This name describes the use of the channel. The name may be customized with the below procedure.

Example: CH69 PLEASURE to HOOKUP

1. Press & hold  ⇒ “CHANNEL SETUP” ⇒ “CHANNEL NAME”

2. Press the [▲] or [▼] key to select the channel to be named, then press the [SELECT] soft key.
3. Press the [▲]/[▼]/[◀]/[▶] keys to select the first letter of the new channel name.
4. Press the [SELECT] soft key to store the first letter of the name and step to the next letter to the right.

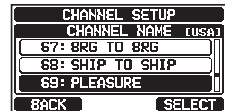

5. Repeat step 3 and 4 until the name is complete. The name can consist of up to 15 characters, if you do not use all 15 characters, select “→” to move to the next space. This method can also be used to enter a blank space in the name.

If a mistake is made entering the channel name, press the [▲]/[▼]/[◀]/[▶] keys to select “←” or “→”, press the [SELECT] soft key until the incorrect character is selected, then perform steps 3 and 4.

6. When finished entering the channel name (using 15 characters or less), press the [FINISH] soft key to save the name.
7. To enter the name of another channel, repeat the steps 2 through 6.
8. Press the [CLEAR] key to return to radio operation.



NOTE

When “CHANNEL NAME” is assigned to a soft key, the channel name may be displayed directly by pressing the [NAME] soft key during radio operation.

16.10 RX LED DIMMER ADJUSTMENT

This menu selection adjusts the RX LED intensity.

1. Press & hold [MENU YSET] → “CHANNEL SETUP” → “RX LED DIMMER”
2. Press the [▲] or [▼] key to select the desired level (“7” is default). When “OFF” is selected, the lamp is turned OFF.
3. Press the [ENTER] soft key to store the selected level.
4. Press the [CLEAR] key to return to radio operation.

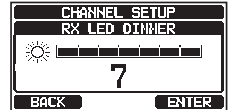

16.11 SUMMARY OF THE CANNEL FUNCTION SETUP

Item	Description	Default Value	Page
CHANNEL GROUP	Selects the channel group	(Depending on the transceiver version)	28
WEATHER ALERT (USA version only)	Turns the Weather Alert Function ON or OFF	ON	87
SCAN MEMORY	Add or remove a channel from Scan Memory	–	31
SCAN TYPE	Select priority scan or memory scan	PRIORITY	31
SCAN RESUME	Sets the resume time of scanning	3 sec	87
MULTI WATCH	Selects Dual Watch or Triple Watch	DUAL	30
PRIORITY CHANNEL	Selects a priority channel	CH16	88
SUB CHANNEL	Selects a Sub Channel	CH09	88
CHANNEL NAME	Edit the name of memory channels	–	88
RX LED DIMMER	Adjusts the RX LED dimmer level	7	89

17 DSC SETUP

NOTE: Depending on the transceiver version, some items may not be displayed in the SETUP MENU.

17.1 INDIVIDUAL DIRECTORY

The **GX1850/GX1800** series has a DSC directory that allows you to store a vessel or person's name, and the associated MMSI that you may wish to contact via individual calls, position requests and position report transmissions.

To transmit an individual call, program this directory with the information of the vessel you wish to contact, similar to a cellular phone's contact list.

Refer to section "**11.4.1 Setting up the Individual / Position Call Directory**" for details.

17.2 INDIVIDUAL REPLY

This menu item sets the radio to automatically (default setting) or manually respond to a DSC Individual call requesting you to switch to a working channel for voice communications. When "MANUAL" is selected, the MMSI of the calling vessel is shown allowing you to see who is calling. This function is similar to caller ID on a cellular phone.

Refer to section "**11.4.2 Setting up the Individual Call Reply**" for details.

17.3 INDIVIDUAL ACKNOWLEDGMENT

The radio can be setup to transmit a reply automatically (default), or set so the radio will not reply to an individual DSC call.

Refer to section "**11.4.3 Enabling the Individual Call Acknowledgment**" for details.

17.4 INDIVIDUAL RINGER

The radio can be setup to ring like a telephone to alert you that the radio has received a DSC individual call. The default ring time setting is 2 minutes, however this can be changed to 5, 10 or 15 seconds with the procedure below.

Refer to section "**11.4.6 Setting up the Individual Call Ringer**" for details.

17.5 GROUP DIRECTORY

For this function to operate, the same group MMSI must be programmed into all the DSC VHF radios within the group of vessels that will be using this feature.

Refer to section "**11.5.1 Setting up a Group Call**" for details.

17.6 POSITION REPLY

The **GX1850/GX1800** series can be set up to automatically (default setting) or manually send your position when requested by another vessel. This selection is important if you are concerned about someone polling the position of your vessel that you may not want to. In the manual mode you will see the MMSI (Maritime Mobile Service Identity Number) or persons name, shown on the display allowing you to choose whether or not to send your position to the requesting vessel.

Refer to section “**11.6.1 Setting up a Position Request Reply**” for details.

17.7 AUTO POSITION POLLING

The **GX1850/GX1800** series has the capability to automatically poll and track seven vessels programmed into the individual directory.

Refer to section “**11.8 AUTO POSITION POLLING**” for details.

17.8 AUTO POSITION INTERVAL

The time interval between automatic position polling request transmissions may be selected.

Refer to section “**11.8.2 Setting up the Polling Time Interval**” for details.

17.9 AUTO CHANNEL CHANGE

When a DSC distress call, or an all ships (urgency or safety) call is received, the **GX1850/GX1800** series will automatically switch to Channel 16.

The automatic switch time may be changed. The default selection is 30 seconds.

1. Press & hold  ⇒ “DSC SETUP” ⇒ “AUTO CHANNEL CHANGE”
2. Press the [**▲**] or [**▼**] key to select the desired time, then press the [**ENTER**] soft key.
3. Press the [**CLEAR**] key to return to radio operation.

When “**OFF**” is selected, the “**D**” icon will light up on the screen.



17.10 NO ACTION TIMER

If no key is pressed during the “MENU” or “DSC CALL” screen, the transceiver will automatically return to radio operation.

The default selection is 10 minutes.

1. Press & hold  → “DSC SETUP” → “NO ACTION TIMER”

2. Press the [▲] or [▼] key to select the desired time, then press the [ENTER] soft key.
3. Press the [CLEAR] key to return to radio operation.



17.11 WAIT TIME FOR POSITION FIX

This menu allows you to select the maximum wait time till obtaining position information when receiving a distress call, POS Report call, or acknowledgment to POS request call.

The default selection is 15 seconds.

1. Press & hold  → “DSC SETUP” → “POS UNFIX WAITING TIME”

2. Press the [▲] or [▼] key to select the desired time, then press the [ENTER] soft key.
3. Press the [CLEAR] key to return to radio operation.



17.12 DSC BEEP

This feature allows the alarm beeps to be turned ON or OFF when a DSC call is received. The DSC calls that can be customized are: individual, group, all ships, position request, position report, geographical, polling, and DSC test. Refer to section “11.5.4 Setting up the Group Call Ringer” for details.

17.13 WARNING ALARM

NOTE: This alarm may not be displayed on all transceiver versions.

The transceiver DSC warning alarm may be turned OFF.

By default, “NO MMSI” and “NO POSITION” are turned “ON”.

1. Press & hold  → “DSC SETUP” → “WARNING ALARM”

2. Press the [▲] or [▼] key to select the item to be set, then press the [SELECT] soft key.
3. Press the [▲] or [▼] key to select “ON” or “OFF”.



4. Press the [ENTER] soft key to save the setting.
5. Press the [CLEAR] key to return to radio operation.

17.14 SUMMARY OF THE DSC SETUP MENU

Item	Description	Default Value	Page
INDIVIDUAL DIRECTORY	Enter or edit addresses used for individual call	-	44
INDIVIDUAL REPLY	Selects a reply to an individual call	MANUAL	45
INDIVIDUAL ACK.	Selects the message to be sent automatically as an individual call acknowledgement	ABLE	46
INDIVIDUAL RING	Selects the ringing time when an individual call or a position request is received	2 min	49
GROUP DIRECTORY	Enter or edit addresses used for group calling	-	50
POSITION REPLY	Selects reply mode when receiving a position call	AUTO	55
AUTO POSITION POLLING	Selects the AUTO POSITION POLLING operation type	AUTO POS REPORT	62
AUTO POS INTERVAL	Selects the AUTO POSITION POLLING transmission interval	30 sec	62
AUTO CHANNEL CHANGE	Selects the delay time to automatically move to the requested channel after receiving a distress call, All Ship call, or group call	30 sec	91
NO ACTION TIMER	Selects the delay time before automatically returning to routine transceiver operation when no key is pressed	10 min	92
POS UNFIX WAITING TIME	Sets the maximum wait time to obtain position information when receiving a distress call, POS Report call, or acknowledgement to POS request call	15 sec	92
DSC BEEP	Turns the audible alarm ON or OFF when receiving a DSC call	INDIVIDUAL CALL:ON GROUP CALL: ON ALL SHIPS: ON POS REQUEST: OFF POS REPORT: OFF GEOGRAPHICAL:ON DSC TEST CALL:ON	92
WARNING ALARM	Turns the DSC alarm ON or OFF	NO MMSI: ON NO POSITION: ON	92

18 GPS SETUP

The “GPS Setup” mode allows the parameters for the NMEA2000 or the NMEA-0183 or the Internal GPS receiver to be customized for your operating requirements.

18.1 ORDER OF PRIORITY (GX1850 series only)

Specify the order of priority of the input devices to be used for obtaining location information. The default setting is “NMEA2000”.

1. Press & hold  **“GPS SETUP”** **“ORDER OF PRIORITY”**

2. Press the [**▲**] or [**▼**] key to select “**NMEA2000**” or “**NMEA-0183**”, then press the [**ENTER**] soft key to save the new setting.

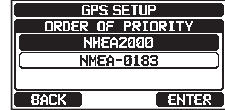

3. Press the [**CLEAR**] key to return to radio operation.

NOTE

The Internal GPS receiver is always set as the lowest priority.

18.2 COMPASS DIRECTION

This menu item selects the compass direction to be shown on the transceiver display. The default setting is “NORTH-UP”.

1. Press & hold  **“GPS SETUP”** **“COMPASS DIRECTION”**

2. Press the [**▲**] or [**▼**] key to select the desired compass display to “**COURSE-UP**” or “**NORTH-UP**”.

3. Press the [**ENTER**] soft key to save the new setting.

4. Press the [**CLEAR**] key to return to radio operation.

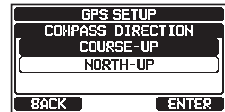

18.3 LOCATION FORMAT

This menu item selects the coordinate system to be shown on the transceiver series display. The default setting is “ddd°mm.mmmm”.

1. Press & hold  **“GPS SETUP”** **“LOCATION FORMAT”**

2. Press the [**▲**] or [**▼**] key to select the desired coordinate system. The location format can be selected from “**ddd°mm.mmmm**” and “**ddd°mm’ss”**”.

3. Press the [**ENTER**] soft key to save the new setting.

4. Press the [**CLEAR**] key to return to radio operation.



18.4 TIME OFFSET

Sets the local time offset between UTC (Universal Time Coordinated) and local time shown on the display. The offset is added or subtracted from the time received from the GPS.

Refer to section “8.8.1 Setting the GPS Time” for details.

18.5 TIME AREA

This menu selection sets the display to show UTC time or local time with the offset.

Refer to section “8.8.2 Setting the Time Area” for details.

18.6 TIME FORMAT

This menu selection sets the display to show time in 12-hour or 24-hour format.

Refer to section “8.8.3 Setting the Time Format” for details.

18.7 UNITS OF MEASURE

This section sets the display units of speed, distance and altitude.

1. Press & hold  → “GPS SETUP” → “UNIT OF MEASURE”

2. Press the [▲] or [▼] key to select the item to be set.

3. Press the [SELECT] soft key.

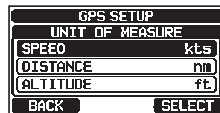

4. Press the [▲] or [▼] key to select the unit.

5. Press the [ENTER] soft key to store the new setting.

6. Press the [CLEAR] key to return to radio operation.

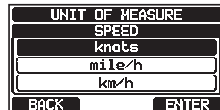

18.8 MAGNETIC VARIATION

This selection permits customization of the GPS COG (Course Over Ground) indication on the normal and compass pages, and BRG on the waypoint page.

Refer to section “8.8.4 Setting COG to True or Magnetic” for details.

NOTE

Setting to “ON” is effective only when the RMC sentences with magnetic data are input from external devices such as a GPS chart plotter.

18.9 NMEA 0183 IN/OUT

18.9.1 Data Speed

This menu is utilized to set the NMEA 0183 baud rate of the GPS input (Yellow and Green wires) and DSC output (White and Brown wires). The default setting is 4800 bps.

When 38400 bps is selected the DSC sentences (DSC & DSE) are output on the White and Brown wires after a DSC distress, position request is received.

1. Press & hold  **“GPS SETUP”** **“NMEA 0183 IN/OUT”**

2. Press the [**▲**] or [**▼**] key to select **“DATA SPEED”**, then press the [**SELECT**] soft key.



3. Press the [**▲**] or [**▼**] key to select the desired speed from **“4800bps”** and **“38400bps”**.
4. Press the [**ENTER**] soft key to save the new setting.
5. Press the [**CLEAR**] key to return to radio operation.

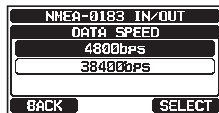

18.9.2 Output Sentences

This selection is utilized to set the NMEA output sentences of the transceiver. By default, the “GLL” and the “RMC” sentences are turned “ON”.

1. Press & hold  **“GPS SETUP”** **“NMEA 0183 IN/OUT”**

2. Press the [**▲**] or [**▼**] key to select **“OUTPUT SENTENCES”**, then press the [**SELECT**] soft key.

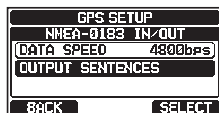

3. Press the [**▲**] or [**▼**] key to select the desired sentence type, then press the [**SELECT**] soft key.



4. Press the [**▲**] or [**▼**] key to select **“ON”** or **“OFF”**.
5. Press the [**ENTER**] soft key to save the new setting.
6. Repeat steps 3 through 5 to set the other sentences.
7. Press the [**CLEAR**] key to return to radio operation.

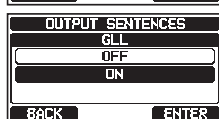

NOTE

- Data output will be performed according to the data acquisition priority order setting of **“ORDER OF PRIORITY”**. Refer to section **“18.1 ORDER OF PRIORITY (GX1850 series only)”** for details.
- When **“UNIT POWER”** of **“OPTION GPS UNIT”** is set to OFF, NMEA sentences will not be output. (OPTION GPS reception data will be output as is.)
- The output interval of each NMEA sentence depends on the output timing on the input device. However, sentences which include POS data will be output at intervals of two seconds or less.
- When all sentences are set to be output, depending on the baud rate, not all sentences can be output at intervals of one second or less. GSA and GSV sentences will be output at intervals of around five seconds.

18.10 Position Data Output

Select the connection device to be used when outputting position data.

1. Press & hold  ⇒ “GPS SETUP” ⇒ “OPTION GPS UNIT”
2. Press the [▲] or [▼] key to select “POS DATA OUTPUT”, then press the [SELECT] soft key.
3. Press the [▲] or [▼] key to select “NMEA 2000” or “NMEA 0183”, then press the [SELECT] soft key.
4. Press the [▲] or [▼] key to select “OFF” or “ON”.
5. Press the [ENTER] soft key to store the new setting.
6. Press the [CLEAR] key to return to radio operation.

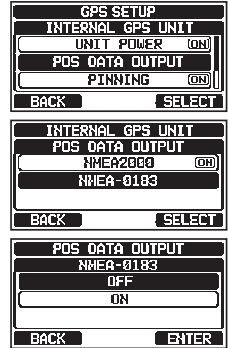

18.11 INTERNAL GPS UNIT

Change the internal GPS receiver settings. (The settings in this section are also valid when connecting the **SCU-38** External GPS Antenna to the internal GPS receiver.)

18.11.1 Unit Power

When the internal GPS receiver is used, set this selection to “ON”. The default setting is “ON”.

1. Press & hold  ⇒ “GPS SETUP” ⇒ “INTERNAL GPS UNIT”
2. Press the [▲] or [▼] key to select “UNIT POWER”, then press the [SELECT] soft key.
3. Press the [▲] or [▼] key to select “OFF” or “ON”.
4. Press the [ENTER] soft key to store the new setting.
5. Press the [CLEAR] key to return to radio operation.

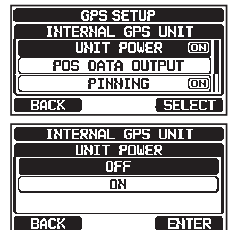

18.11.2 Pinning

This selection is utilized to enable or disable position updates when the vessel is not underway. The default setting is “ON”.

1. Press & hold  → “GPS SETUP” → “INTERNAL GPS UNIT”

2. Press the [▲] or [▼] key to select “PINNING”, then press the [SELECT] soft key.

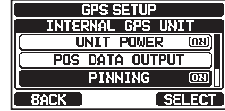

3. Press the [▲] or [▼] key to select “OFF” or “ON”.
ON: When pinning is turned ON, the transceiver will not update its position unless the ship’s speed is over 0.4 knot.

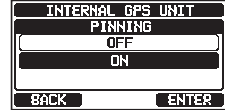

OFF: When the vessel is underway or stopped, the transceiver continuously updates its position.

This improves accuracy of the position fix.

4. Press the [ENTER] soft key to save the new setting.
5. Press the [CLEAR] key to return to routine transceiver operation.

18.11.3 Differential GPS

This selection enables or disables differential GPS function by SBAS (Satellite Based Augmentation System) such as WAAS, EGNOS, MSAS and GAGAN. In some areas (Australia for example), the GPS reception can have problems enabling the SBAS. The default setting is “ON”.

1. Press & hold  → “GPS SETUP” → “INTERNAL GPS UNIT”

2. Press the [▲] or [▼] key to select “D-GPS”, then press the [SELECT] soft key.



3. Press the [▲] or [▼] key to select “OFF” or “ON”.
4. Press the [ENTER] soft key to store the new setting.
5. Press the [CLEAR] key to return to radio operation.

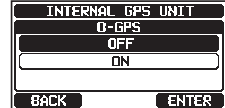

18.12 SUMMARY OF THE GPS SETUP

Item	Description	Default Value	Page
ORDER OF PRIORITY (GX1850 series only)	Sets the priority order of the connection devices when obtaining position information	NMEA-2000	94
COMPASS DIRECTION	Selects the compass direction to be displayed	NORTH-UP	94
LOCATION FORMAT	Selects the coordinate system to be displayed	ddd°mm.mmmm	94
TIME OFFSET	Sets the offset time from UTC (available only when "LOCAL" is selected in the item "TIME AREA")	00:00	95
TIME AREA	Selects the time location to be displayed, from UTC or local	UTC	95
TIME FORMAT	Selects the time format to be displayed, 12-hour or 24-hour (fixed to "24H" when "UTC" is selected in the item "TIME AREA")	24hour	95
UNITS OF MEASURE	Selects the unit of measure when displaying speed, distance, and altitude	SPEED: kts (knots) DISTANCE: nm (nautical mile) ALTITUDE: ft (feet)	95
MAGNETIC VARIATION	Enables/disables the magnetic variation function	OFF	95
NMEA 0183 IN/OUT			
DATA SPEED	Sets the NMEA 0183 data speed	4800bps	95
OUTPUT SENTENCES	Enables/disables NMEA sentences	GLL: ON GGA: OFF GSA: OFF GSV: OFF RMC: ON DSC/DSE: OFF	96
INTERNAL GPS UNIT			
UNIT POWER	Enables/disables the OPTION GPS UNIT	ON	97
POS DATA OUTPUT	Selects the connection device when outputting position data	NMEA 2000: OFF NMEA-0183: OFF	97
PINNING	Turns on or off GPS position updates for vessel not underway	ON	98
D-GPS	Turns SBAS ON or OFF	ON	98

19 ATIS SETUP (GX1850GPS/E and GX1800GPS/E only)

The **GX1850GPS/E** and **GX1800GPS/E** supports the ATIS (Automatic Transmitter Identification System) used in Inland waterways in Europe. When enabled ATIS mode transmits a unique ATIS code each time the PTT switch is released at the end of a transmission.

Users should check with their local marine regulatory authority in their country for assistance in obtaining an ATIS code.

WARNING

The ATIS code can be inputted only once, please be careful not to input the incorrect ATIS code. If the ATIS code needs to be reset, please contact Standard Horizon to obtain the required reset code. Refer to section “15.6.1 Reset the USER MMSI and ATIS CODE”.

19.1 ATIS CODE PROGRAMMING

1. Press & hold  **“ATIS SETUP”** **“ATIS CODE”**

2. Press the [**◀**] or [**▶**] key to select the first number of your ATIS, then press the [**SELECT**] soft key to step to the next number.

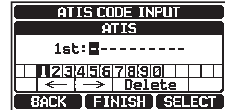

3. Repeat step 2 to set the ten digits of the ATIS.

4. If a mistake is made in entering the ATIS, press the [**▲**]/[**▼**]/[**◀**]/[**▶**] keys to select “←” or “→”, press the [**SELECT**] soft key until the incorrect number is selected, then perform step 2.

5. When entering the number is complete, press the [**FINISH**] soft key. The Radio will ask you to input the ATIS number again. Perform steps 2 through 4 above.

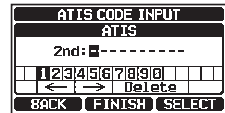

6. After the number has been entered twice, press the [**FINISH**] soft key to store the ATIS number in memory.

7. Press the [**OK**] soft key to return to radio operation.



19.2 ATIS CH GROUP

The **GX1850GPS/E** and **GX1800GPS/E** ATIS feature may be turned ON or OFF for each channel group.

1. Press & hold  → “ATIS SETUP” → “ATIS GROUP”

2. Press the [▲] or [▼] key to select the channel group (International, Canadian*, or USA) to change the setting, and then press the [SELECT] soft key.



*(Depending on the region setting.)

3. Press the [▲] or [▼] key to select “ON” or “OFF”.

4. Press the [ENTER] soft key to save the new setting.

5. To set the ATIS feature for another channel group, repeat steps 2 through 4.



6. Press the [BACK] soft key to return to radio operation.

NOTE

- The “Scan” and “Dual Watch” features are not available on the channel group while the ATIS feature is turned on.
- The TX output power is set to “1 W” automatically on the following channels of the channel group while the ATIS feature is turned on.
CH 06, 08, 10, 11, 12, 13, 14, 15, 17, 71, 72, 74, 75, 76, and 77

20 SSM-70H (RAM4) REMOTE MIC OPERATION

When a remote microphone is connected to the **GX1850/GX1800** series, all VHF, DSC, setup menus, Navigation and GM (Group Monitor) functions can be remotely operated. The **SSM-70H** operation is the same as the **GX1850/GX1800** series except for the receiver audio volume setting and the squelch level setting. The reason for combined controlling is to make the operation of the radio and **SSM-70H** Remote Microphone uncomplicated. For specific operations of the **SSM-70H** Remote Microphone, review sections in the transceiver operating manual. The **SSM-70H** is supplied with 7 meters of routing cable and can be extended up to 21 meters using three 7-meter extension cables model **CT-100**. The Intercom feature can be used between the **SSM-70H** and the **GX1850/GX1800** series. In addition, speaker wires are supplied at the panel mount of the routing cable for external speakers to be connected for use in noisy environments.

20.1 REMOTE MIC CONTROLS

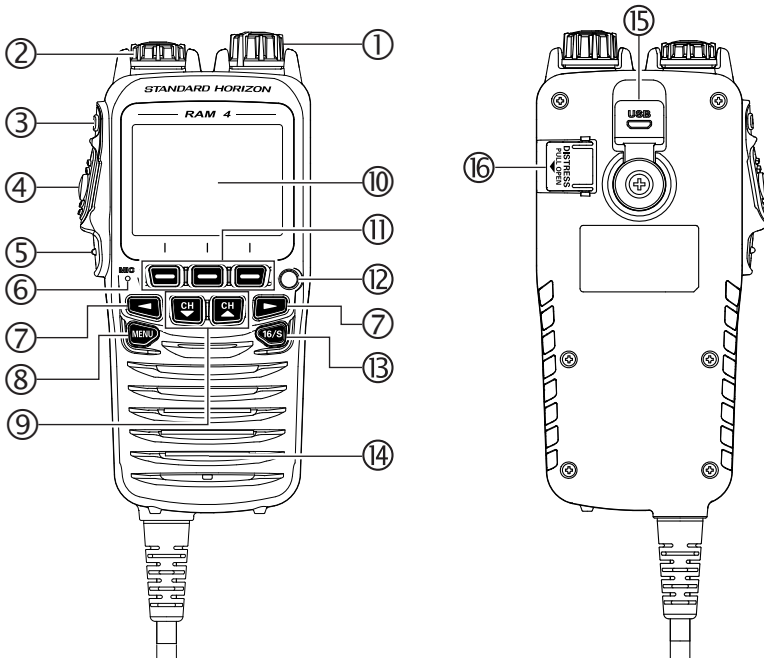

- ① **Power/VOL knob**
Press and hold this knob to turn the transceiver and the remote mic ON or OFF.
Rotate this knob to adjust the internal speaker volume.
- ② **DIAL/ENT knob**
While the normal screen is displayed, rotate the **DIAL/ENT** knob to select your desired channel. While the MENU screen is displayed, rotate the knob to select the desired menu item.
SECONDARY USE
Press this knob to enter a selection in the MENU.
- ③ **SQL key** (Squelch control)
Press this key to activate the squelch adjusting mode. Press the **CH▲** or **CH▼** key to adjust the squelch threshold level.
- ④ **PTT** (Push-To-Talk) **switch**
Push this switch to enable the transmitter.
- ⑤ **CLEAR/🔒 key**
Press this key to cancel a menu selection. Press and hold this key to activate the key lock function. Press and hold this key again to deactivate the key lock function.
- ⑥ **Microphone**
The internal microphone transmits your voice while reducing background noise using Clear Voice Noise Reduction Technology.
NOTE: Position the microphone about 1.5 cm away from your mouth and speak in a normal voice.
- ⑦ **◀ & ▶ keys**
When the soft keys are displayed, press these keys to switch the function of the soft keys.
SECONDARY USE
While the MENU screen is displayed, press the keys to slide the on-screen menu to the right/left side.
- ⑧ **MENU key**
Press to access the MENU.
Press and hold this key to access the SETUP MENU.
- ⑨ **CH▼ & CH▲ keys**
These keys are used to change the operating channel.
Press the key momentarily, the channel increases or decreases one step. Hold the key and the channel increases or decreases continuously.
SECONDARY USE
 - While the MENU screen is displayed, press the key to slide the on-screen menu upward/downward.
 - When in the PA or Fog mode, press the key to change the channel.

⑩ Display

Full dot matrix display, 222 by 162 pixels.

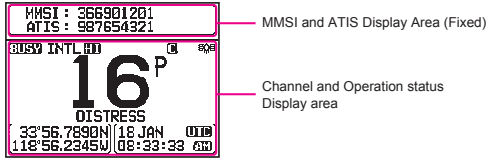

⑪ Soft keys

These three programmable keys can be customized utilizing the setup menu. Press one of these keys, to display the key functions at the bottom of the display. Refer to section “**20.2 RAM4 SOFT KEY ASSIGNMENT**” for details.

⑫ Strobe Light

When the [**STROBE**] soft key is pressed, the internationally recognized Morse Code “S.O.S” message will light and flash repeatedly. From MENU → SETUP → CONFIGURATION → STROBE LED, the strobe light may be set to one option from: “CONTINUOUS”, “SOS”, “BLINK 1”, “BLINK 2” or “BLINK 3”.

⑬ 16/S key

Pressing this key immediately reverts to channel 16 from any channel location. Holding down this key recalls the SUB channel (The default setting is channel 9). Press this key again to revert to the previously selected working channel.

⑭ Speaker

The internal speaker is located here.

⑮ DATA jack















Use the micro USB type B jack for **SSM-70H (RAM4)** firmware updates. NOTE: When the DATA jack is securely covered with the rubber cap, the SSM-70H meets the waterproof performance.

⑯ DISTRESS key

This key is used to send a DSC distress call. Refer to section “**11 DIGITAL SELECTIVE CALLING (DSC)**”.

20.2 RAM4 SOFT KEY ASSIGNMENT

From this menu, desired functions may be assigned to each **RAM4** soft key from numbers 01 to 12. Also, the duration the soft key icon will be displayed after the corresponding soft key is pressed may be set. The keys may be setup to control the following functions:

DISPLAY	SOFT KEY ICON	FUNCTION	SOFT KEY NUMBERS ASSIGNED AS DEFAULT (See the previous page.)
NONE	–	–	–
WX/CH		Switches between weather and marine channels	01 (GX1850GPS, GX1850, GX1800GPS, GX1800)
SCAN		Turns the scanning function ON or OFF	05
SCAN MEMORY		Add or remove channels from memory channel scan	04
MULTI WATCH		Starts and stops dual watch scan or triple watch scan	06
PRESET		Programs or deletes the preset memory channel	10 (GX1850GPS, GX1850, GX1800GPS, GX1800) 01 (GX1850GPS/E, GX1800GPS/E)
INTERCOM		Activates intercom communication between radio and the optional RAM4 mic (SSM-70H)	11
MARK POSITION		Marks the current position for a “Waypoint”	07
NAVIGATION		Enables the “Waypoint” or “Route” navigation display	08
COMPASS		Enables the “Compass” display	09
TX HI/LO		Selects transmit power	02
MAN OVERBOARD		Marks the position where a person falls overboard	03
STROBE		Turns the strobe light LED ON or OFF	12
CH NAME		Edit channel names	10 (GX1850GPS/E, GX1800GPS/E)
DISPLAY MODE		Switches the display between daytime or nighttime mode	

NOTE

Soft key functions may be assigned individually for the transceiver and the optional **SSM-70H (RAM4)** remote microphone.

20.2.1 Key Assignment

Customize the functions of SSM-70H (RAM4) remote microphone soft keys for personal preferences.

NOTE: It is necessary to make the settings using the keys or the **DIAL/ENT** knob on the SSM-70H (RAM4).

1. Press & hold  **"CONFIGURATION"**  **"SOFT KEY"**
(RAM4W)

2. Rotate the **DIAL/ENT** knob to select **"KEY ASSIGNMENT"**, then press the **[SELECT]** soft key.



3. Rotate the **DIAL/ENT** knob to select the key number to be programmed, and press the **[SELECT]** soft key.



4. Rotate the **DIAL/ENT** knob to select a new function from the choices listed, and then press the **[ENTER]** soft key. When **"NONE"** is selected, the soft key assignment is removed.



5. Repeat steps 3 and 4 to program other soft keys.

The VHF radio's functions can be assigned to the maximum of 12 soft keys.

6. Press the **[CLEAR/On]** key to return to radio operation.

21 MAINTENANCE

The inherent quality of the solid-state components used in this transceiver will provide many years of continuous use. Taking the following precautions will prevent damage to the transceiver.

- Never key the microphone unless an antenna or suitable dummy load is connected to the transceiver.
- Ensure that the supply voltage to the transceiver does not exceed 16 VDC or fall below 11 VDC.
- Use only STANDARD HORIZON approved accessories and replacement parts.

21.1 REPLACEMENT PARTS

Occasionally an owner needs a replacement mounting bracket or knob. These can be ordered from your Dealer.

Commonly requested parts, and their part numbers are listed below.

- **DC Power Cord:** T9025406
- **VOL and SQL Knob:** RA618980A (White), RA618990A (Black)
- **Mounting Bracket:** RA6203800 (White), RA6203900 (Black)
- **Mounting Bracket Knob:** RA6204000 (White), RA6204100 (Black)
- **Microphone Hanger:** RA0436000 (White), RA0458800 (Black)
- **RAM4 Mic Routing Cable Assembly:** S8101512

21.2 FACTORY SERVICE

In the unlikely event that the transceiver fails to perform or needs servicing, please contact one of following:

In USA and Canada

Standard Horizon

Attention Marine Repair Department

6125 Phyllis Drive, Cypress, California 90630, U.S.A.

Telephone (800) 366-4566

In Europe

Yaesu (UK) Ltd

Unit 12, Sun Valley Business Park, Winnall Close

Winchester, Hampshire, SO23 0LB, U. K.

Telephone +44 (0)1962 866667

In Other Countries

Contact the dealer or the distributor.

21.3 TROUBLESHOOTING CHART

SYMPTOM	PROBABLE CAUSE	REMEDY
Transceiver fails to power up.	No DC voltage to the transceiver, or blown fuse.	a. Check the 12 VDC battery connections and the fuse. b. The  key needs to be pressed and held to turn the radio on.
Transceiver blows fuse when connected to power supply.	Reversed power wires.	Check the power cable for DC voltage, or replace the fuse (6A). Make sure the red wire is connected to the positive (+) battery post, and the black wire is connected to the negative (-) battery post. If the fuse still blows, contact your Dealer.
Popping or whining noise from the speaker while engine runs.	Engine noise.	Re-route the DC power cables away from the engine. Add noise suppressor on power cable. Change to resistive spark plug wires and/or add an alternator whine filter.
Sound is not emitted from the internal or external speaker.	Accessory cable.	Check the connections of the accessory cable. External speaker cable (WHITE/SHIELD) may be shorted together.
Receiving station reports low transmit power, even with transceiver set to HI power.	Antenna.	Have the antenna checked or test the transceiver with another antenna. If the problem persists, contact your Dealer for servicing.
“HI BATTERY” or “LO BATTERY” message appears when the power is turned on.	The power supply voltage is too high or too low.	Confirm that the connected power supply voltage is between 11 volts and 16.5 volts DC.
Your position is not displayed.	Setting of the GPS SETUP.	Check the “UNIT POWER” setting is “ON”. For details, refer to the “ 18.11.1 Unit Power ”.
	Accessory cable.	Check the accessory cable connection. Some GPS use the battery ground for NMEA connection.
	SCU-38 cable.	Check the SCU-38 cable connection.
	Setting of the GPS chart plotter.	Check the output signal format of the GPS navigation receiver. This radio requires NMEA 0183 and NMEA 2000 format with GLL, RMB, or RMC sentence as an output signal. If the GPS has a baud rate setting make sure to select 4800 and parity to NONE.

22 CHANNEL ASSIGNMENTS

22.1 GX1850GPS, GX1850, GX1800GPS and GX1800

VHF MARINE CHANNEL CHART							
CH	U	C	I	S/D	TX	RX	CHANNEL USE
01		X	X	D	156.050	160.650	Public Correspondence (Marine Operator)
1001	X			S	156.050		Port Operation and Commercial. VTS in selected areas
02		X	X	D	156.100	160.700	Public Correspondence (Marine Operator)
03		X	X	D	156.150	160.750	Public Correspondence (Marine Operator)
1003	X			S	156.150		U.S. Government Only, Coast Guard
04			X	D	156.200	160.800	Public Correspondence (Marine Operator), Port operation, ship movement
1004		X		S	156.200		Pacific coast: Coast Guard, East Coast: Commercial fishing
05			X	D	156.250	160.850	Public Correspondence (Marine Operator), Port operation, ship movement
1005	X	X		S	156.250		Port operation. VTS in Seattle
06	X	X	X	S	156.300		Inter-ship Safety
07			X	D	156.350	160.950	Public Correspondence (Marine Operator), Port operation, ship movement
1007	X	X		S	156.350		Commercial
08	X	X	X	S	156.400		Commercial (Inter-ship only)
09	X	X	X	S	156.450		Boater Calling channel, Commercial & Non-commercial (Recreational)
10	X	X	X	S	156.500		Commercial
11	X	X	X	S	156.550		Commercial. VTS in selected areas.
12	X	X	X	S	156.600		Port operation. VTS in selected areas.
13	X	X	X	S	156.650		Inter-ship Navigation Safety (Bridge-to-bridge)
14	X	X	X	S	156.700		Port operation. VTS in selected areas.
15	X			S	---	156.750	Environmental (Receive only)
15		X	X	S	156.750		Commercial, non-commercial, ship movement (1 W)
16	X	X	X	S	156.800		International Distress, Safety and Calling
17	X	X	X	S	156.850		State Controlled (1 W)
18			X	D	156.900	161.500	Port operation, ship movement
1018	X	X		S	156.900		Commercial
19			X	D	156.950	161.550	Port operation, ship movement
1019	X	X		S	156.950		Commercial (USA) Coast Guard (Canada)
1019			X	S	156.950		
2019			X	S	161.550		
20	X	X	X	D	157.000	161.600	Canadian Coast Guard Only, International: port operations and shipment
1020			X	S	157.000		
1020	X			S	157.000		Port operation
2020			X	S	161.600		
21			X	D	157.050	161.650	Port operation, ship movement
1021	X	X		S	157.050		U.S. Government Only (USA) Canadian Coast Guard (Canada)
2021		X			---	161.650	CMB Service

VHF MARINE CHANNEL CHART									
CH	U	C	I	S/D	TX		RX		CHANNEL USE
22			X	D	157.100	161.700	Port operation, ship movement		
1022	X	X		S	157.100		US Coast Guard Liaison and Maritime Safety Information Broadcasts announced on channel 16 (USA) Canadian Coast Guard Liaison and Maritime Safety Information Broadcasts announced on channel 16 (Canada)		
23		X	X	D	157.150	161.750	Public Correspondence (Marine Operator)		
1023	X			S	157.150		U.S. Government Only		
2023		X			---	161.750	CMB Service		
24	X	X	X	D	157.200	161.800	Public Correspondence (Marine Operator)		
25	X	X	X	D	157.250	161.850	Public Correspondence (Marine Operator)		
2025		X			---	161.850	CMB Service		
26	X	X	X	D	157.300	161.900	Public Correspondence (Marine Operator)		
27	X	X	X	D	157.350	161.950	Public Correspondence (Marine Operator)		
28	X	X	X	D	157.400	162.000	Public Correspondence (Marine Operator)		
2028		X			---	162.000	CMB Service		
60		X	X	D	156.025	160.625	Public Correspondence (Marine Operator)		
61			X	D	156.075	160.675	Public Correspondence (Marine Operator), Port operation, ship movement		
1061	X	X		S	156.075		Public Coast: Coast Guard; East Coast: commercial fishing only		
62			X	D	156.125	160.725	Public Correspondence (Marine Operator), Port operation, ship movement		
1062		X		S	156.125		Public Coast: Coast Guard; East Coast: commercial fishing only		
63			X	D	156.175	160.775	Public Correspondence (Marine Operator), Port operation, ship movement		
1063	X	X		S	156.175		Port Operation and Commercial. VTS in selected areas.		
64		X	X	D	156.225	160.825	Public Correspondence (Marine Operator), Port operation, ship movement		
1064	X	X		S	156.225		Public Correspondence (Marine Operator), Port operation, ship movement		
65			X	D	156.275	160.875	Public Correspondence (Marine Operator), Port operation, ship movement		
1065	X	X		S	156.275		Port Operations		
66			X	D	156.325	160.925	Public Correspondence (Marine Operator), Port operation, ship movement		
1066	X	X		S	156.325		Port Operations		
67	X	X	X	S	156.375		US: Commercial. Used for Bridge-to-bridge communications in lower Mississippi River. Inter-ship only. Canada: Commercial fishing, S&R		
68	X	X	X	S	156.425		Non-commercial (Recreational)		
69	X	X	X	S	156.475		US: Non-commercial (Recreational), Canada: Commercial fishing only, International: Inter-ship, Port operations and Ship movement		
70	X	X	X	S	---	156.525	Digital selective calling (voice communications not allowed)		
71	X	X	X	S	156.575		US, Canada: Non-commercial (Recreational), International: Port operations and Ship movement		

VHF MARINE CHANNEL CHART								
CH	U	C	I	S/D	TX		RX	CHANNEL USE
72	X	X	X	S	156.625			Non-commercial (Inter-ship only)
73	X	X	X	S	156.675			US: Port Operations, Canada: Commercial fishing only, International: Inter-ship, Port operations and Ship movement
74	X	X	X	S	156.725			US: Port Operations, Canada: Commercial fishing only, International: Inter-ship, Port operations and Ship movement
75	X	X	X	S	156.775			Port Operations (Inter-ship only) (1 W)
76	X	X	X	S	156.825			Port Operations (Inter-ship only) (1 W)
77	X	X		S	156.875			Port Operations (Inter-ship only) (1 W)
77			X	S	156.875			Port Operations (Inter-ship only)
78			X	D	156.925	161.525		Public Correspondence (Marine Operator), Port operation, ship-movement
1078	X	X		S	156.925			Non-commercial (Recreational)
1078			X	S	156.925			Port operation and Ship movement
2078			X	S	161.525			
79			X	D	156.975	161.575		Port operation and Ship movement
1079	X	X		S	156.975			Commercial
1079			X	S	156.975			Port operation and Ship movement
2079			X	S	161.575			
80			X	D	157.025	161.625		Port operation, ship movement
1080	X	X		S	157.025			Commercial
81			X	D	157.075	161.675		Port operation, ship movement
1081	X	X		S	157.075			U.S. Government Only - Environmental protection operations. (USA) Canadian Coast Guard Only (Canada)
82			X	D	157.125	161.725		Public Correspondence (Marine Operator), Port operation, ship movement
1082	X	X		S	157.125			U.S. Government Only (USA) Canadian Coast Guard Only (Canada)
83			X	D	157.175	161.775		Public Correspondence (Marine Operator)
1083	X	X		S	157.175			U.S. Government Only (USA) Canadian Coast Guard Only (Canada)
2083		X			---	161.775		CMB Service
84	X	X	X	D	157.225	161.825		Public Correspondence (Marine Operator)
85	X	X	X	D	157.275	161.875		Public Correspondence (Marine Operator)
86	X	X	X	D	157.325	161.925		Public Correspondence (Marine Operator)
87	X	X	X	S	157.375			Port operation, ship movement
88	X	X	X	S	157.425			Port operation, ship movement Commercial, Inter-ship Only

NOTE: Simplex channels, 1003, 1021, 1023, 1061, 1064, 1081, 1082 and 1083 CANNOT be lawfully used by the general public in U.S.A. waters.

22.2 GX1850GPS/E and GX1800GPS/E

CH	TX (MHz)	RX (MHz)	SIMPLEX/DUPLEX	LOW PWR	CHANNEL USE	
					All countries (except Germany)	Germany
01	156.050	160.650	DUPLEX	–	TELEPHONE	NAUTIK
02	156.100	160.700	DUPLEX	–	TELEPHONE	NAUTIK
03	156.150	160.750	DUPLEX	–	TELEPHONE	NAUTIK
04	156.200	160.800	DUPLEX	–	INTL	NAUTIK
05	156.250	160.850	DUPLEX	–	INTL	NAUTIK
06	156.300		SIMPLEX	LOW*4	SAFETY	SHIP-SHIP
07	156.350	160.950	DUPLEX	–	INTL	NAUTIK
08	156.400		SIMPLEX	LOW*4	COMMERCIAL	SHIP-SHIP
09	156.450		SIMPLEX	–	CALLING	NAUTIK
10	156.500		SIMPLEX	LOW*4	COMMERCIAL	SHIP-SHIP
11	156.550		SIMPLEX	LOW*4	VTS	SHIP-PORT
12	156.600		SIMPLEX	LOW*4	VTS	SHIP-PORT
13	156.650		SIMPLEX	LOW*4	BRG/BRG	SHIP-SHIP
14	156.700		SIMPLEX	LOW*4	VTS	SHIP-PORT
15	156.750		SIMPLEX	LOW	COMMERCIAL	ON-BOARD
16	156.800		SIMPLEX	–	DISTRESS	
17	156.850		SIMPLEX	LOW	SAR	ON-BOARD
18	156.900	161.500	DUPLEX	–	INTL	NAUTIK
19	156.950	161.550	DUPLEX	–	INTL	NAUTIK
1019*7	156.950		SIMPLEX	–	–	–
2019*7	161.550		SIMPLEX	–	–	–
20	157.000	161.600	DUPLEX	LOW*6	PORT OPR	NAUTIK
1020*7	157.000		SIMPLEX	–	–	–
2020*7	161.600		SIMPLEX	–	–	–
21	157.050	161.650	DUPLEX	–	INTL	NAUTIK
22	157.100	161.700	DUPLEX	–	INTL	NAUTIK
23	157.150	161.750	DUPLEX	–	INTL	
24	157.200	161.800	DUPLEX	–	TELEPHONE	
25	157.250	161.850	DUPLEX	–	TELEPHONE	
26	157.300	161.900	DUPLEX	–	TELEPHONE	
27	157.350	161.950	DUPLEX	–	TELEPHONE	
28	157.400	162.000	DUPLEX	–	TELEPHONE	
31*1	157.550	162.150	DUPLEX	LOW	NED JACHTHAV	–
37*2	157.850		SIMPLEX	LOW	YACHTING UK	–
60	156.025	160.625	DUPLEX	–	TELEPHONE	NAUTIK
61	156.075	160.675	DUPLEX	–	INTL	NAUTIK
62	156.125	160.725	DUPLEX	–	INTL	NAUTIK
63	156.175	160.775	DUPLEX	–	INTL	NAUTIK
64	156.225	160.825	DUPLEX	–	TELEPHONE	NAUTIK
65	156.275	160.875	DUPLEX	–	INTL	NAUTIK
66	156.325	160.925	DUPLEX	–	INTL	NAUTIK
67	156.375		SIMPLEX	–	BRG/BRG	NAUTIK
68	156.425		SIMPLEX	–	SHIP-SHIP	
69	156.475		SIMPLEX	–	PLEASURE	
70	–	156.525	SIMPLEX	–	DSC	
71	156.575		SIMPLEX	LOW*4	PLEASURE	SHIP-PORT
72	156.625		SIMPLEX	LOW*4	SHIP-SHIP	
73	156.675		SIMPLEX	–	PORT OPR	NAUTIK
74	156.725		SIMPLEX	LOW*4	PORT OPR	SHIP-PORT
75	156.775		SIMPLEX	LOW	–	SHIP-PORT
76	156.825		SIMPLEX	LOW	–	NAUTIK

CH	TX (MHz)	RX (MHz)	SIMPLEX/DUPLEX	LOW PWR	CHANNEL USE	
					All countries (except Germany)	Germany
77	156.875		SIMPLEX	LOW*4	PORT OPR	SHIP-SHIP
78	156.925	161.525	DUPLEX	–	INTL	NAUTIK
1078*7	156.925		SIMPLEX	–	–	–
2078*7	161.525		SIMPLEX	–	–	–
79	156.975	161.575	DUPLEX	–	INTL	NAUTIK
1079*7	156.975		SIMPLEX	–	–	–
2079*7	161.575		SIMPLEX	–	–	–
80	157.025	161.625	DUPLEX	–	INTL	NAUTIK
81	157.075	161.675	DUPLEX	–	INTL	NAUTIK
82	157.125	161.725	DUPLEX	–	INTL	TELEPHONE
83	157.175	161.775	DUPLEX	–	INTL	TELEPHONE
84	157.225	161.825	DUPLEX	–	TELEPHONE	
85	157.275	161.875	DUPLEX	–	TELEPHONE	
86	157.325	161.925	DUPLEX	–	TELEPHONE	
87	157.375		SIMPLEX	–	PORT OPR	
88	157.425		SIMPLEX	–	PORT OPR	
M*3	157.850		SIMPLEX	–	YACHTING UK	–
M2*3	161.425		SIMPLEX	–	YACHTING UK	–
L1*5	155.500		SIMPLEX	–	PLEASURE	–
L2*5	155.525		SIMPLEX	–	PLEASURE	–
L3*5	155.650		SIMPLEX	–	PLEASURE	–
F1*5	155.625		SIMPLEX	–	FISHING	–
F2*5	155.775		SIMPLEX	–	FISHING	–
F3*5	155.825		SIMPLEX	–	FISHING	–

NOTE: Country Channel assignment are different depending on the region.

*1: Channel 31 is assigned to only BELGIUM and NETHERLAND.

*2: Channel 37 is assigned to only NETHERLAND.

*3: Channel M and M2 are assigned to only UNITED KINGDOM.

*4: LOW Power setting for BELGIUM, NETHERLAND and GERMANY.

*5: Channel L1, L2, L3, F1, F2 and F3 are assigned to only SWEDEN.

*6: LOW Power setting for GERMANY.

*7: Not assigned for NORWAY.

23 SPECIFICATIONS

Performance specifications are nominal, unless otherwise indicated, and are subject to change without notice. Measured in accordance with TIA/EIA-603.

● GENERAL

Channels	All International, USA and Canadian* *(Depending on the region setting)
Normal Input Voltage	13.8 V DC
Operating Voltage Range	11 V to 16.5 V
Current Drain	
Standby	0.45 A
Receiver (at Maximum AF Output)	0.8 A
Transmit	5.0 A (Hi), 1.0 A (Lo)
NMEA 2000 Load Equivalency Number* ¹	LEN=1
* ¹ (GX1850GPS, GX1850GPS/E and GX1850 only)	
DSC Transmitted Call Log	24
DSC Distress Call Log	27
DSC Received Call Log	64
Individual Directory	100
Group Directory	32
Waypoint Directory	250
Route Directory	20
Display Type	2.6" x 1.4" (66 x 36 mm) Full Dot Matrix (222 x 122 pixels)
Dimensions (W x H x D)	5.9" x 3.4" x 3.3" (150 x 85 x 82 mm)
Flush-Mount Dimensions (W x H x D) ...	5.43" x 2.87" x 3.74" (138 x 73 x 95 mm)
Weight	2.1 lbs (940 g)

● TRANSMITTER

Frequency Range	156.025 MHz to 161.600 MHz (INTERNATIONAL)
RF Output Power	25 W (Hi), 1 W (Lo)
Conducted Spurious Emissions	Less than -80 dBc (Hi), -66 dBc (Lo)
Audio Response	within +1/-3dB of a 6 dB/Octave pre-emphasis characteristic at 300 to 3000 Hz
Audio Distortion	Less than 5 %
Modulation	16K0G3E (for Voice), 16K0G2B (for DSC)
Frequency Stability	±0.0003 % (-4 °F to +140 °F [-20 °C to +60 °C])
FM Hum and Noise	50 dB

●RECEIVER (for Voice and DSC)

Frequency Range	156.050 MHz to 163.275 MHz
Sensitivity	
20 dB Quieting	0.30 μ V
12 dB SINAD	0.25 μ V
Squelch Sensitivity (Threshold)	0.13 μ V
Modulation Acceptance Bandwidth	\pm 7.5 kHz
Selectivity (Typical)	
Spurious and Image Rejection	75 dB for Voice (75 dB for DSC)
Intermodulation and Rejection	75 dB for Voice (70 dB for DSC)
Audio Output	4.5 W (at 4 ohms external speaker output)
Audio Response	within +1/-3dB of a 6 dB/Octave de-emphasis characteristic at 300 to 3000 Hz
Frequency Stability	\pm 0.0003 % (-20 °C to +60 °C)
Channel Spacing	25 kHz
DSC Format	ITU-R M.493-13 (European version: Meets ITU-R M493-14)

●INTERNAL GPS RECEIVER (GX1850GPS, GX1850GPS/E, GX1800GPS and GX1800GPS/E only)

Receiver Channels	66 Channels
Sensitivity	Less than -147 dBm
Time to First Fix	1 minute typical (@Cold Start) 5 seconds typical (@ Hot Start)
Geodetic Datum	WGS84

NMEA 0183 INPUT/OUTPUT Sentences

4800 Baud selected:

NMEA 0183 Input (4800 baud)	GGA, GLL, GNS, RMC, GSA, & GSV
NMEA 0183 Output (4800 baud)	DSC, DSE, GGA* ² , GLL* ² , GNS* ² , RMC* ² , GSA* ² & GSV* ²

38400 Baud selected:

NMEA 0183-HS Input (38400 baud) ...	GGA, GLL, GNS, RMC, GSA, & GSV
NMEA 0183-HS Output (38400 baud)	DSC, DSE, GGA* ² , GLL* ² , GNS* ² , RMC* ² , GSA* ² & GSV* ²

*²(GX1850GPS, GX1850GPS/E, GX1800GPS and GX1800GPS/E only)

23.1 DIMENSIONS

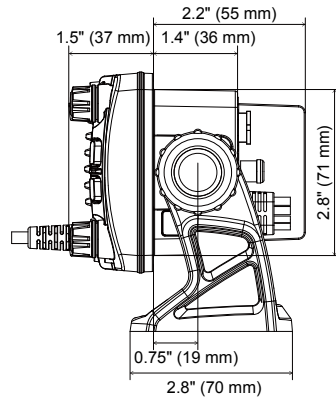
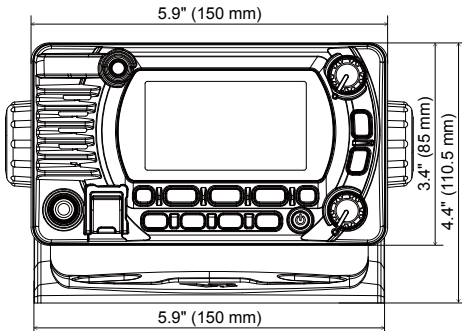
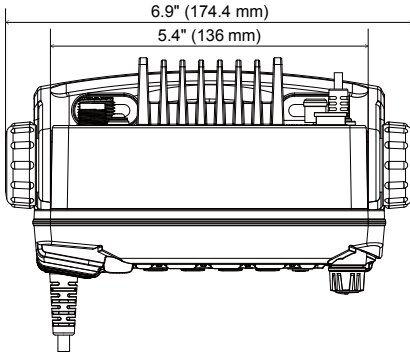
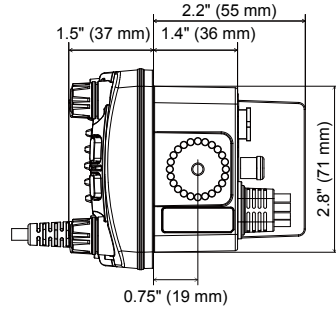
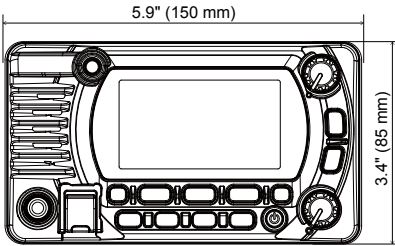
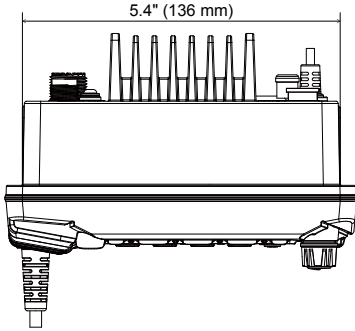

24 FCC RADIO LICENSE INFORMATION

Standard Horizon radios comply with the Federal Communication Commission (FCC) requirements that regulate the Maritime Radio Service.

24.1 STATION LICENSE

An FCC ship station license is no longer required for any vessel traveling in U.S. waters (except Hawaii) which is under 20 meters in length. However, any vessel required to carry a marine radio on an international voyage, carrying a HF single side band radiotelephone or marine satellite terminal is required to have a ship station license. FCC license forms, including applications for ship (605) and land station licenses can be downloaded via the Internet at <https://www.fcc.gov/fcc-form-605>. To obtain a form from the FCC, call (888) 225-5322.

24.2 RADIO CALL SIGN

Currently the FCC does not require recreational boaters to have a Ship Radio Station License. The USCG recommends the boats registration number and the state to be used when calling another vessel.

24.3 CANADIAN SHIP STATION LICENSING

Please click on the following link for licensing information:
http://www.ic.gc.ca/eic/site/smt-gst.nsf/eng/h_sf01775.html

The following link lists several Branches/Offices regarding licensing. Licensing depends on the region of operations.
<http://www.ic.gc.ca/eic/site/smt-gst.nsf/eng/sf01742.html>

24.4 FCC / IC INFORMATION

The following data pertaining to the transceiver is necessary to fill out the license application.

FCC Type Accepted	FCC Part 80
IC Type Accepted	RSS-182
Output Power	1 Watt (low) and 25 Watts (high)
Emission	16K0G3E, 16K0G2B
Frequency Range	156.025 to 163.275 MHz
FCC ID	K6630643X3D
IC	511B-30643X3D

25 FCC NOTICE

NOTICE

Unauthorized changes or modifications to this equipment may void compliance with FCC Rules. Any change or modification must be approved in writing by STANDARD HORIZON.

NOTICE

This equipment has been tested and found to comply with the limits for a Class B digital device, pursuant to Part 15 of the FCC Rules. These limits are designed to provide reasonable protection against harmful interference in a residential installation. This equipment generates, uses and can radiate radio frequency energy and, if not installed and used in accordance with the instructions, may cause harmful interference to radio communications. However, there is no guarantee that interference will not occur in a particular installation. If this equipment does cause harmful interference to radio or television reception, which can be determined by turning the equipment off and on, the user is encouraged to try to correct the interference by one or more of the following measures:

- Reorient or relocate the receiving antenna.
- Increase the separation between the equipment and receiver.
- Connect the equipment into an outlet on a circuit different from that to which the receiver is connected.
- Consult the dealer or an experienced radio/TV technician for help.

WARNING

It is a violation of the rules of the Federal Communications Commission to input an MMSI that has not been properly assigned to the end user, or to otherwise input any inaccurate data in this device.

THIS DEVICE COMPLIES WITH PART 15 OF THE FCC RULES. OPERATION IS SUBJECT TO THE FOLLOWING TWO CONDITIONS: (1) THIS DEVICE MAY NOT CAUSE HARMFUL INTERFERENCE, AND (2) THIS DEVICE MUST ACCEPT ANY INTERFERENCE RECEIVED, INCLUDING INTERFERENCE THAT MAY CAUSE UNDESIRE OPERATION.

Changes or modifications to this device not expressly approved by YAESU U.S.A. could void the User's authorization to operate this device.

This device complies with Industry Canada license-exempt RSS standard(s). Operation is subject to the following two conditions: (1) this device may not cause interference, and (2) this device must accept any interference, including interference that may cause undesired operation of the device.

Le présent appareil est conforme aux CNR d'Industrie Canada applicables aux appareils radio exempts de licence. L'exploitation est autorisée aux deux conditions suivantes : (1) l'appareil ne doit pas produire de brouillage, et (2) l'utilisateur de l'appareil doit accepter tout brouillage radioélectrique subi, même si le brouillage est susceptible d'en compromettre le fonctionnement.

Under Industry Canada regulations, this radio transmitter may only operate using an antenna of a type and maximum (or lesser) gain approved for the transmitter by Industry Canada. To reduce potential radio interference to other users, the antenna type and its gain should be so chosen that the equivalent isotropically radiated power (e.i.r.p.) is not more than that necessary for successful communication.

Conformément à la réglementation d'Industrie Canada, le présent émetteur radio peut fonctionner avec une antenne d'un type et d'un gain maximal (ou inférieur) approuvé pour l'émetteur par Industrie Canada. Dans le but de réduire les risques de brouillage radioélectrique à l'intention des autres utilisateurs, il faut choisir le type d'antenne et son gain de sorte que la puissance isotrope rayonnée équivalente (p.i.r.e.) ne dépasse pas l'intensité nécessaire à l'établissement d'une communication satisfaisante.

STANDARD HORIZON Limited Warranty

Limited Warranty is valid only in the country/region where this product was originally purchased.

On-line Warranty Registration:

Thank you for buying STANDARD HORIZON products! We are confident your new radio will serve your needs for many years! Please register your product at www.standardhorizon.com - Owner's Corner

Warranty Terms:

Subject to the Limitations of the Warranty and the Warranty Procedures described below, YAESU MUSEN hereby warrants this product to be free of defects in materials and workmanship in normal use during the "Warranty Period." (the "Limited Warranty").

Limitations of Warranty:

- A. YAESU MUSEN is not liable for any express warranties except the Limited Warranty described above.
- B. The Limited Warranty is extended only to the original end-use purchaser or the person receiving this product as a gift, and shall not be extended to any other person or transferee.
- C. Unless a different warranty period is stated with this YAESU product, the Warranty Period is three years from the date of retail purchase by the original end-use purchaser.
- D. The Limited Warranty is valid only in the country/region where this product was originally purchased.
- E. During the Warranty Period, YAESU MUSEN will, at its sole option, repair or replace (using new or refurbished replacement parts) any defective parts within a reasonable period of time and free of charge.
- F. The Limited Warranty does not cover shipping cost (including transportation and insurance) from you to us, or any import fees, duties or taxes.
- G. The Limited Warranty does not cover any impairment caused by tampering, misuse, failure to follow instructions supplied with the product, unauthorized modifications, or damage to this product for any reasons, such as: accident; excess moisture; lightning; power surges; connection to improper voltage supply; damage caused by inadequate packing or shipping procedures; loss of, damage to or corruption of stored data; product modification to enable operation in another country/purpose other than the country/purpose for which it was designed, manufactured, approved and/or authorized; or the repair of products damaged by these modifications.
- H. The Limited Warranty applies only to the product as it existed at the time of the original purchase, by the original retail purchaser, and shall not preclude YAESU MUSEN from later making any changes in design, adding to, or otherwise improving subsequent versions of this product, or impose upon YAESU MUSEN any obligation to modify or alter this product to conform to such changes, or improvements.
- I. YAESU MUSEN assumes no responsibility for any consequential damages caused by, or arising out of, any such defect in materials or workmanship.
- J. TO THE FULLEST EXTENT PERMITTED BY LAW, YAESU MUSEN SHALL NOT BE RESPONSIBLE FOR ANY IMPLIED WARRANTY WITH RESPECT TO THIS PRODUCT.
- K. If the original retail purchaser timely complies with the Warranty Procedures described below, and YAESU MUSEN elects to send the purchaser a replacement product rather than repair the "original product", then the Limited Warranty shall apply to the replacement product only for the remainder of the original product Warranty Period.
- L. Warranty statutes vary from state to state, or country to country, so some of the above limitations may not apply to your location.

Warranty Procedures:

1. To find the Authorized STANDARD HORIZON Service Center in your country/region, visit www.standardhorizon.com. Contact the STANDARD HORIZON Service Center for specific return and shipping instructions, or contact an authorized STANDARD HORIZON dealer/distributor from whom the product was originally purchased.
2. Include proof of original purchase from an authorized STANDARD HORIZON dealer/distributor, and ship the product, freight prepaid, to the address provided by the STANDARD HORIZON Service Center in your country/region.
3. Upon receipt of this product, returned in accordance with the procedures described above, by the STANDARD HORIZON Authorized Service Center, all reasonable efforts will be expended by YAESU MUSEN to cause this product to conform to its original specifications. YAESU MUSEN will return the repaired product (or a replacement product) free of charge to the original purchaser. The decision to repair or replace this product is the sole discretion of YAESU MUSEN.

Other conditions:

YAESU MUSEN'S MAXIMUM LIABILITY SHALL NOT EXCEED THE ACTUAL PURCHASE PRICE PAID FOR THE PRODUCT. IN NO EVENT SHALL YAESU MUSEN BE LIABLE FOR LOSS OF, DAMAGE TO OR CORRUPTION OF STORED DATA, OR FOR SPECIAL, INCIDENTAL, CONSEQUENTIAL, OR INDIRECT DAMAGES, HOW EVER CAUSED; INCLUDING WITHOUT LIMITATION TO THE REPLACEMENT OF EQUIPMENT AND PROPERTY, AND ANY COSTS OF RECOVERING, PROGRAMMING OR REPRODUCING ANY PROGRAM OR DATA STORED IN OR USED WITH THE YAESU PRODUCT.

Some Countries in Europe and some States of the USA do not allow the exclusion or limitation of incidental or consequential damages, or a limitation on how long an implied warranty lasts, so the above limitation or exclusions may not apply. This warranty provides specific rights, there may be other rights available which may vary between countries in Europe or from state to state within the USA.

This Limited Warranty is void if the label bearing the serial number has been removed or defaced.

cut here

TEMPLATE for the GX1850/GX1800 series

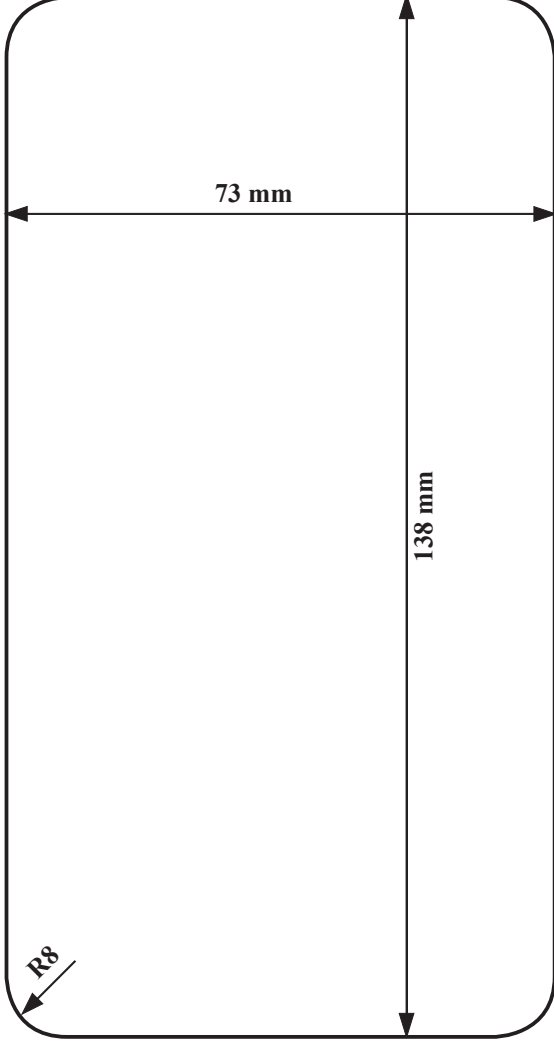

Use this template to mark the location where the rectangular hole for the flush mount is to be cut.

EU Declaration of Conformity

We, Yaesu Musen Co. Ltd of Tokyo, Japan, hereby declare that this radio equipment GX1850GPS/E and GX1800GPS/E is in full compliance with EU Radio Equipment Directive 2014/53/EU. The full text of the Declaration of Conformity for this product is available to view at [://www.yaesu.com/jp/red](http://www.yaesu.com/jp/red)

ATTENTION – Condition of use

This transceiver operates on frequencies that are regulated. Use of the Transmitter in the EU countries shown in the accompanying table is not permitted without authorization. Users should consult their local spectrum management authority for licensing conditions applicable to this equipment.

					
AT	BE	BG	CY	CZ	DE
DK	ES	EE	FI	FR	UK
EL	HR	HU	IE	IT	LT
LU	LV	MT	NL	PL	PT
RO	SK	SI	SE	CH	IS
LI	NO	–	–	–	–

Disposal of Electronic and Electrical Equipment

Products with the symbol (crossed-out wheeled bin) cannot be disposed as household waste.

Electronic and Electrical Equipment should be recycled at a facility capable of handling these items and their waste by-products.

Please contact a local equipment supplier representative or service center for information about the waste collection system in your country.



STANDARD HORIZON

Nothing takes to water like Standard Horizon

Copyright 2021
YAESU MUSEN CO., LTD.
All rights reserved.

No portion of this manual may be
reproduced without the permission of
YAESU MUSEN CO., LTD.

YAESU MUSEN CO., LTD.

Tennozu Parkside Building
2-5-8 Higashi-Shinagawa, Shinagawa-ku, Tokyo 140-0002 Japan

YAESU USA

6125 Phyllis Drive, Cypress, CA 90630, U.S.A.

YAESU UK

Unit 12, Sun Valley Business Park, Winnall Close
Winchester, Hampshire, SO23 0LB, U.K.

2109B-BC

Printed in China



E M O 6 4 N 2 0 1